

Microsemi Power Portfolio 2018



Power Semiconductors

Power Modules

RF Power MOSFETs

Contents

High-Voltage SMPS Transistors

Insulated Gate Bipolar Transistors (IGBTs).....	3
Silicon Carbide (SiC) MOSFETs.....	7
Power MOS 8™ MOSFETs/FREDFETs.....	8
Ultra-Fast, Low Gate Charge MOSFETs	10
Super Junction MOSFETs.....	11
Linear MOSFETs.....	11

Diodes

SiC Schottky Barrier Diodes	12
Si Schottky Barrier Diodes, Fast and Ultra-Fast Recovery Diodes	12

High-Voltage RF MOSFETs.....	15
------------------------------	----

High-Frequency RF MOSFETs.....	15
--------------------------------	----

Drivers and Driver-RF MOSFET Hybrids	16
--	----

Reference Design Kits	16
-----------------------------	----

Power Modules

Power Modules Contents	17
Standard Electrical Configurations	18
Packaging	19
Custom Power Modules	20
Rugged Custom Power Modules.....	21
Power Module Part Numbering System.....	22
IGBT Power Modules	23
Intelligent Power Modules.....	26
MOSFET Power Modules	27
Renewable Energy Power Modules	31
Power Modules with SiC Schottky Diodes.....	33
SiC MOSFET Power Modules.....	35
Diode Power Modules	36

Package Outlines	37
------------------------	----

Power Module Outlines	38
-----------------------------	----

Insulated Gate Bipolar Transistors (IGBTs)

IGBTs from Microsemi

IGBT products from Microsemi provide high-quality solutions for a wide range of high-voltage, high-power applications. The switching frequency range spans from DC for minimal conduction loss to 150 kHz for very-high-power-density switch mode power supply (SMPS) applications. The frequency range for each product type is shown in the following graph. Each IGBT product represents the latest in IGBT technology, providing the best possible performance/cost combination for the targeted application. There are six product series that utilize three different IGBT technologies: non-punch-through (NPT), punch-through (PT), and field stop.

IGBT Switching Frequency Ranges (kHz, Hard Switched)

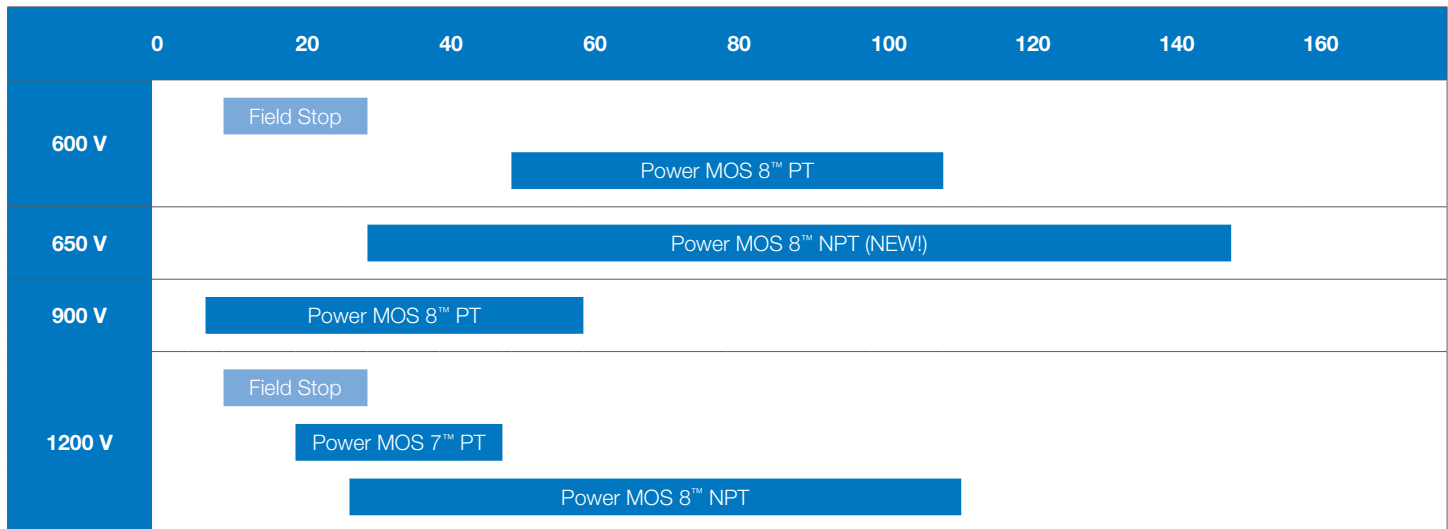

Note: Frequency ranges shown are typical for a 50 A IGBT. Refer to product datasheet maximum frequency versus current graph for more information.

Standard Series	Voltage Ratings (V)	Technology	Easy to Parallel	Short Circuit Safe Operating Area (SOA)	Parameter
MOS 7™	1200	PT			Ultra-low gate charge
MOS 8™	600, 650, 900, 1200	PT, NPT			Highest efficiency
Field Stop Trench Gate	600, 1200	Field Stop	•	•	Lowest conduction loss

Product Options

All standard IGBT products are available as a single IGBT or as a Combi product packaged with an anti-parallel DQ series diode. Package options include TO-220, TO-247, T-MAX®, TO-264, and SOT-227. Customized products are available; contact the factory for details.

IGBTs—Punch-Through

	$V_{(BR)CES}$ (V)	$V_{CE(ON)}$ (V) Typ 25 °C	I_{C2} (A) 100 °C	Maximum I_C (A) at Frequency		Part Number	Package Style
				20 kHz	40 kHz		
POWER MOS 7™	Single						
<ul style="list-style-type: none"> Ultra-low gate charge Combi with high-speed DQ diode 	1200	3.3	33	19	12	APT25GP120BG	TO-247
		3.3	46	24	15	APT35GP120BG	TO-247
		3.3	54	29	18	APT45GP120BG	TO-247
		3.3	34	28	18	APT45GP120J	ISOTOP
		3.3	91	42	24	APT75GP120B2G	T-MAX®
		3.3	57	40	23	APT75GP120J	ISOTOP
	Combi (IGBT & "DQ" FRED)						
	1200	3.3	33	19	12	APT25GP120BDQ1G	TO-247
		3.3	46	24	15	APT35GP120B2DQ2G	T-MAX®
		3.3	54	29	18	APT45GP120B2DQ2G	T-MAX®
		3.3	34	28	18	APT45GP120JDQ2	ISOTOP
3.3		57	40	23	APT75GP120JDQ3	ISOTOP	
POWER MOS 8™	Single						
<ul style="list-style-type: none"> Fast switching Highest efficiency Combi with high-speed DQ diode 	600	2	36	21	17	APT36GA60B	TO-247 or D3PAK
		2	44	26	20	APT44GA60B	TO-247 or D3PAK
		2	54	30	23	APT54GA60B	TO-247 or D3PAK
		2	68	35	27	APT68GA60B	TO-247 or D3PAK
		2	80	40	31	APT80GA60B	TO-247 or D3PAK
		2	102	51	39	APT102GA60B2	T-MAX® or TO-264
	900	2.5	35	17	10	APT35GA90B	TO-247 or D3PAK
		2.5	43	21	13	APT43GA90B	TO-247 or D3PAK
		2.5	64	29	19	APT64GA90B	TO-247 or D3PAK
		2.5	80	34	23	APT80GA90B	TO-247 or D3PAK
Combi (IGBT & "DQ" FRED)							
600	2	36	21	17	APT36GA60BD15	TO-247 or D3PAK	
	2	44	26	20	APT44GA60BD30	TO-247 or D3PAK	
	2	54	30	23	APT54GA60BD30	TO-247 or D3PAK	
	2	60	48	36	APT60GA60JD60	ISOTOP®	
	2	68	35	27	APT68GA60B2D40	T-MAX® or TO-264	
	2	80	40	31	APT80GA60LD40	TO-264	
900	2.5	27	14	8	APT27GA90BD15	TO-247 or D3PAK	
	2.5	35	17	10	APT35GA90BD15	TO-247 or D3PAK	
	2.5	43	21	13	APT43GA90BD30	TO-247 or D3PAK	
	2.5	46	33	21	APT46GA90JD40	ISOTOP®	
	2.5	64	29	19	APT64GA90B2D30	T-MAX® or TO-264	
	2.5	80	34	23	APT80GA90LD40	TO-264	

Part numbers for D3PAK packages—replace "B" with "S" in part number. Part numbers for TO-264 packages—replace "B2" with "L" in part number.

Current at frequency test conditions: $T_j = 125\text{ °C}$, $T_c = 100\text{ °C}$ except Isotop® where $T_c = 80\text{ °C}$, $V_{cc} = 67\%$ rated voltage hard switch.

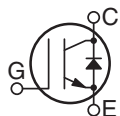
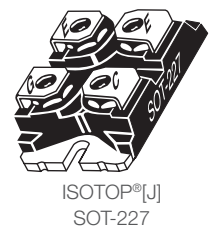
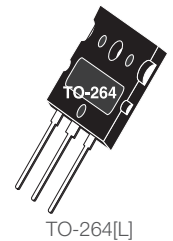
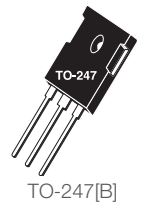

IGBTs—Non-Punch-Thru

POWER MOS 8™	V _{(BR)CES} (V)	V _{CE(ON)} (V) Typ 25 °C	I _{C2} (A) 100 °C	Maximum I _C (A) at Frequency		Part Number	Package Style
				150 kHz	200 kHz		
650	Single	1.9	45	31	25	APT45GR65B	TO-247
				100 kHz	150 kHz		
		1.9	70	52	39	APT70GR65B	TO-247
				50 kHz	100 kHz		
1200	Single	1.9	95	69	41	APT95GR65B2	T-MAX®
				50 kHz	80 kHz		
		2.5	25	25	21	APT25GR120B	TO-247
		2.5	25	25	21	APT25GR120S	D3PAK
		2.5	40	38	28	APT40GR120B	TO-247
		2.5	40	38	28	APT40GR120S	D3PAK
		2.5	50	48	36	APT50GR120B2	T-MAX®
		2.5	50	48	36	APT50GR120L	TO-264
				25 kHz	50 kHz		
		2.5	70	66	42	APT70GR120B2	T-MAX®
		2.5	70	66	42	APT70GR120L	TO-264
		2.5	70*	42	30	APT70GR120J	ISOTOP®
		2.5	85	72	46	APT85GR120B2	T-MAX®
		2.5	85	72	46	APT85GR120L	TO-264
		2.5	85*	46	31	APT85GR120J	ISOTOP®
Combi (IGBT & Diode)				150 kHz	200 kHz		
650	Single	1.9	45	31	25	APT45GR65BSCD10	TO-247 (SiC SBD)
				100 kHz	150 kHz		
		1.9	70	52	39	APT70GR65B2SCD30	T-MAX® (SiC SBD)
1200	Single			50 kHz	80 kHz		
		2.5	25	25	21	APT25GR120BD15	TO-247 (DQ)
		2.5	25	25	21	APT25GR120SD15	D3PAK (DQ)
		2.5	25	25	21	APT25GR120BSCD10	TO-247 (SiC SBD)
		2.5	25	25	21	APT25GR120SSCD10	D3PAK (SiC SBD)
		2.5	40	38	28	APT40GR120B2D30	T-MAX® (DQ)
		2.5	40	38	28	APT40GR120B2SCD10	T-MAX® (SiC SBD)
				25 kHz	50 kHz		
		2.5	50*	42	32	APT50GR120JD30	ISOTOP® (DQ)
		2.5	70*	42	30	APT70GR120JD60	ISOTOP® (DQ)
2.5	85*	46	31	APT85GR120JD60	ISOTOP® (DQ)		

Part numbers for D3PAK packages—replace "B" with "S" in part number. Part numbers for TO-264 packages—replace "B2" with "L" in part number.

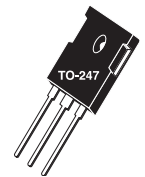

TO-247[B]



D3PAK[S]



T-MAX®[B2]

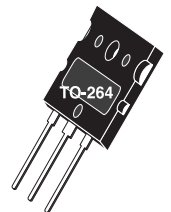

TO-264[L]



ISOTOP®[J]
SOT-227

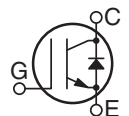

- High-speed switching
- Low switching losses
- Easy to parallel

Current at frequency test conditions: T_j = 125 °C, T_c = 100 °C except Isotop® where T_c = 80 °C, V_{cc} = 67% rated voltage hard switch.

IGBTs—Field Stop

Field Stop	$V_{(BR)CES}$ (V)	$V_{CE(ON)}$ (V) Typ 25 °C	I_{C2} (A) 100 °C	Maximum I_C (A) at Frequency		Part Number	Package Style
				15 kHz	30 kHz		
<ul style="list-style-type: none"> Trench technology Short circuit rated Lowest conduction loss Easy paralleling Combi with high-speed DQ diode 	600	1.5	24	15	10	APT20GN60BG	TO-247
		1.5	37	20	14	APT30GN60BG	TO-247
		1.5	64	30	21	APT50GN60BG	TO-247
		1.5	93	42	30	APT75GN60BG	TO-247
		1.5	123	75	47	APT150GN60J	ISOTOP®
		1.5	135	54	39	APT100GN60B2G	T-MAX®
		1.5	190	79	57	APT150GN60B2G	T-MAX®
		1.5	230	103	75	APT200GN60B2G	T-MAX®
		1.5	158	100	66	APT200GN60J	ISOTOP®
		1200			10 kHz		20 kHz
1.7	33		19	13	APT25GN120BG	TO-247 or D3PAK	
1.7	46		24	17	APT35GN120BG	TO-247	
1.7	66		32	22	APT50GN120B2G	T-MAX®	
1.7	70		44	27	APT100GN120J	ISOTOP®	
1.7	99		45	30	APT75GN120B2G	T-MAX® or TO-264	
1.7	120		58	38	APT100GN120B2G	T-MAX®	
1.7	99		60	36	APT150GN120J	ISOTOP®	
Combi (IGBT & "DQ" FRED)				15 kHz	30 kHz		
600	1.5	24	15	10	APT20GN60BDQ1G	TO-247	
	1.5	37	20	14	APT30GN60BDQ2G	TO-247	
	1.5	64	30	21	APT50GN60BDQ2G	TO-247	
	1.5	93	42	30	APT75GN60LDQ3G	TO-264	
	1.5	123	75	47	APT150GN60JDQ4	ISOTOP®	
	1.5	135	54	39	APT100GN60LDQ4G	TO-264v	
	1.5	190	79	57	APT150GN60LDQ4G	TO-264	
	1.5	158	100	66	APT200GN60JDQ4	ISOTOP®	
1200			10 kHz		20 kHz		
	1.7	22	14	10	APT15GN120BDQ1G	TO-247 or D3PAK	
	1.7	33	19	13	APT25GN120B2DQ2G	T-MAX®	
	1.7	46	24	17	APT35GN120L2DQ2G	264-MAX™	
	1.7	57	36	22	APT75GN120JDQ3	ISOTOP®	
	1.7	66	32	22	APT50GN120L2DQ2G	264-MAX™	
	1.7	70	44	27	APT100GN120JDQ4	ISOTOP®	
	1.7	99	60	36	APT150GN120JDQ4	ISOTOP®	

Part numbers for D3PAK packages—replace "B" with "S" in part number. Part numbers for TO-264 packages—replace "B2" with "L" in part number.

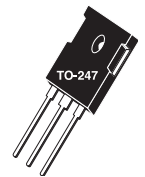

TO-247[B]



D3PAK[S]

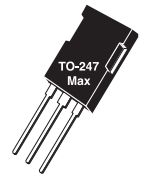

T-MAX®[B2]

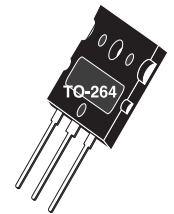

TO-264[L]

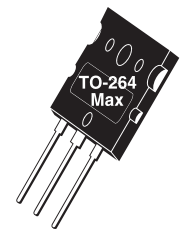

264-MAX™[L2]

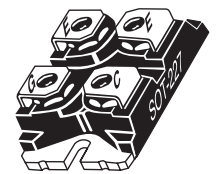

ISOTOP®[J]
SOT-227

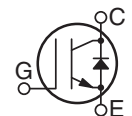

Current at frequency test conditions: $T_j = 125\text{ °C}$, $T_c = 100\text{ °C}$ except Isotop® where $T_c = 80\text{ °C}$, $V_{cc} = 67\%$ rated voltage hard switch.

Silicon Carbide (SiC) MOSFETs

Silicon Carbide (SiC) MOSFETs

Silicon Carbide (SiC) is the ideal technology for higher switching frequency, higher efficiency, and higher power (>650 V) applications. Target markets and applications include:

- Commercial aviation: Actuation, air conditioning, power distribution
- Industrial: Motor drives, welding, uninterruptible power supply (UPS), SMPS, induction heating
- Transportation/automotive: Electric vehicle (EV) battery charger, hybrid electric vehicle (HEV) powertrain, DC-DC converter, energy recovery

- Smart energy: photovoltaic (PV) inverter, wind turbine
- Medical: MRI power supply, X-Ray power supply
- Defense and oil drilling: Motor drives, auxiliary power supplies

SiC MOSFET and SiC Schottky barrier diode product lines from Microsemi increase your system efficiency over silicon MOSFET and IGBT solutions while lowering your total cost of ownership by enabling downsized systems and smaller/lower cost cooling.

Part Number	Voltage (V)	R _{DS(ON)} (Typical)	Package	
MSC090SMA070B	700	90 mΩ	TO-247	
MSC090SMA070S			D3PAK	
MSC060SMA070B		60 mΩ	TO-247	
MSC060SMA070S			D3PAK	
MSC035SMA070B		35 mΩ	TO-247	
MSC035SMA070S			D3PAK	
MSC015SMA070B		15 mΩ	TO-247	
MSC015SMA070S			D3PAK	
MSC280SMA120B	1200	280 mΩ	TO-247	
MSC280SMA120S			D3PAK	
MSC140SMA120B		140 mΩ	TO-247	
MSC140SMA120S			D3PAK	
MSC080SMA120B		80 mΩ	TO-247	
MSC080SMA120S			D3PAK	
MSC080SMA120J		SOT-227		
MSC040SMA120B			TO-247	
MSC040SMA120S		D3PAK		
MSC040SMA120J		SOT-227		
MSC025SMA120B		25 mΩ	TO-247	
MSC025SMA120S			D3PAK	
MSC025SMA120J			SOT-227	
MSC750SMA170B		1700	750 mΩ	TO-247
MSC750SMA170S				D3PAK
MSC045SMA170B			45 mΩ	TO-247
MSC045SMA170S	D3PAK			



TO-247



TO-268
D3PAK

SiC MOSFET Features and Benefits

Characteristics	Results	Benefits
Breakdown field (MV/cm)	Lower on-resistance	Higher efficiency
Electron sat. velocity (cm/s)	Faster switching	Size reduction
Bandgap energy (eV)	Higher junction temperature	Improved cooling
Thermal conductivity (W/m.K)	Higher power density	Higher current capabilities
Positive temperature coefficient	Self regulation	Easy paralleling

Microsemi Advantages Versus Competition

- Lowest conduction losses at high temperature
- Low switching losses
- High short circuit withstand rating
- Low gate resistance
- High avalanche rating: UIS and Repetitive UIS
- Patented SiC technology
- SiC is the perfect technology to address high-frequency and high-power-density applications
- Lower power losses
- Easier cooling, downsized system, and higher reliability

Power MOS 8™ MOSFETs/FREDFETs

V_{DSS} (V)	$R_{DS(ON)}$ Max (Ω)	I_D (A)	MOSFET Part Number	I_D (A)	FREDFET Part Number	Package Style
1200	2.40			7	APT7F120B	TO-247 or D3PAK
	2.10	8	APT7M120B			TO-247
	1.20			14	APT13F120B	TO-247 or D3PAK
	1.10	14	APT14M120B			TO-247
	0.70			23	APT22F120B2	T-MAX® or TO-264
	0.63	24	APT24M120B2			T-MAX® or TO-264
	0.58			27	APT26F120B2	T-MAX® or TO-264
	0.58			18	APT17F120J	ISOTOP®
	0.53	29	APT28M120B2			T-MAX® or TO-264
	0.53	19	APT19M120J			ISOTOP®
	0.32			33	APT32F120J	ISOTOP®
	0.29	35	APT34M120J			ISOTOP®
1000	2.00			7	APT7F100B	TO-247
	1.80	8	APT8M100B			TO-247
	1.60			9	APT9F100B	TO-247 or D3PAK
	1.40	9	APT9M100B			TO-247
	0.98			14	APT14F100B	TO-247 or D3PAK
	0.88	14	APT14M100B			TO-247 or D3PAK
	0.78			17	APT17F100B	TO-247 or D3PAK
	0.70	18	APT18M100B			TO-247
	0.44			30	APT29F100B2	T-MAX® or TO-264
	0.44			20	APT19F100J	ISOTOP®
	0.38	32	APT31M100B2	35	APT34F100B2	T-MAX® or TO-264
	0.38	21	APT21M100J	23	APT22F100J	ISOTOP®
	0.33	37	APT37M100B2			T-MAX® or TO-264
	0.33	25	APT25M100J			ISOTOP®
	0.20			42	APT41F100J	ISOTOP®
0.18	45	APT45M100J			ISOTOP®	
800	0.90			12	APT11F80B	TO-247 or D3PAK
	0.80	13	APT12M80B			TO-247
	0.58			18	APT17F80B	TO-247 or D3PAK
	0.53	19	APT18M80B			TO-247 or D3PAK
	0.43			23	APT22F80B	TO-247 or D3PAK
	0.39	25	APT24M80B			TO-247 or D3PAK
	0.24			41	APT38F80B2	T-MAX® or TO-264
	0.21	43	APT41M80B2	47	APT44F80B2	T-MAX® or TO-264
	0.21			31	APT29F80J	ISOTOP®
	0.19	49	APT48M80B2			T-MAX® or TO-264
	0.19	33	APT32M80J			ISOTOP®
	0.11			57	APT53F80J	ISOTOP®
	0.10	60	APT58M80J			ISOTOP®

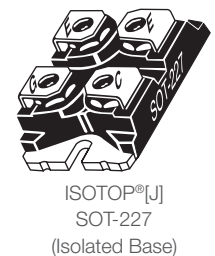
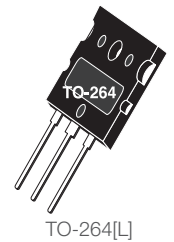
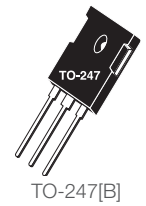

Part numbers for D3PAK packages—replace "B" with "S" in part number. Part numbers for TO-264 packages—replace "B2" with "L" in part number.

Power MOS 8™ MOSFETs/FREDFETs (continued)

BV_{DSS} (V)	$R_{DS(ON)}$ Max (Ω)	I_D (A)	MOSFET Part Number	I_b (A)	FREDFET Part Number	Package Style
600	0.37			19	APT18F60B	TO-247 or D3PAK
	0.29			24	APT23F60B	TO-247 or D3PAK
	0.19	36	APT34M60B	36	APT34F60B	TO-247
	0.15	45	APT43M60B2	45	APT43F60B2	T-MAX® or TO-264
	0.15	31	APT30M60J	31	APT30F60J	ISOTOP®
	0.11	60	APT56M60B2	60	APT56F60B2	T-MAX® or TO-264
	0.11	42	APT39M60J	42	APT39F60J	ISOTOP®
	0.09	70	APT66M60B2	70	APT66F60B2	T-MAX® or TO-264
	0.09	49	APT47M60J	49	APT47F60J	ISOTOP®
	0.055	84	APT80M60J	84	APT80F60J	ISOTOP®
500	0.24			24	APT24F50B	TO-247 or D3PAK
	0.19			30	APT30F50B	TO-247 or D3PAK
	0.15			37	APT37F50B	TO-247 or D3PAK
	0.13			43	APT42F50B	TO-247 or D3PAK
	0.10	56	APT56M50B2	56	APT56F50B2	T-MAX® or TO-264
	0.10	38	APT38M50J	38	APT38F50J	ISOTOP®
	0.075	75	APT75M50B2	75	APT75F50B2	T-MAX® or TO-264
	0.075	51	APT51M50J	51	APT51F50J	ISOTOP®
	0.062	84	APT84M50B2	84	APT84F50B2	T-MAX® or TO-264
	0.062	58	APT58M50J	58	APT58F50J	ISOTOP®
	0.036	103	APT100M50J	103	APT100F50J	ISOTOP®

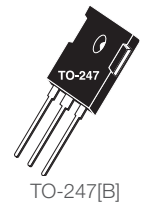

Part numbers for D3PAK packages—replace "B" with "S" in part number. Part numbers for TO-264 packages—replace "B2" with "L" in part number.

Low-Voltage Power MOS V® MOSFETs/FREDFETs

BV_{DSS} (V)	$R_{DS(ON)}$ Max (Ω)	I_D (A)	MOSFET Part Number	I_b (A)	FREDFET Part Number	Package Style
300	0.085	40	APT30M85BVRG			TO-247
	0.070	48	APT30M70BVRG	48	APT30M70BVFRG	TO-247 or D3PAK
	0.040	70	APT30M40JVR	70	APT30M40JVFR	ISOTOP®
	0.019	130	APT30M19JVR	130	APT30M19JVFR	ISOTOP®
200	0.045	56	APT20M45BVRG	56	APT20M45BVFRG	TO-247
	0.038	67	APT20M38BVRG			TO-247 or D3PAK
	0.022	100	APT20M22B2VRG			T-MAX® or TO-264
	0.011	175	APT20M11JVR	175	APT20M11JVFR	ISOTOP®

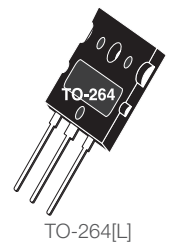

Part numbers for D3PAK packages—replace "B" with "S" in part number. Part numbers for TO-264 packages—replace "B2" with "L" in part number.

Ultra-Fast, Low Gate Charge MOSFETs

For 250 kHz–2 MHz Switching Applications

The ultra-fast, low gate charge MOSFET family combines the lowest gate charge available in the industry with Microsemi's proprietary self-aligned aluminum metal gate structure. The result is a MOSFET capable of extremely fast switching speeds and very low switching losses. The metal gate structure and the layout of these chips provide an internal series gate resistance (EGR) an order of magnitude lower than competitive devices built with a polysilicon gate.

These devices are ideally suited for high-frequency and pulsed high-voltage applications.

Typical Applications

- Class D amplifiers up to 2 MHz
- High-voltage pulsed DC
- AM transmitters
- Plasma deposition/etch

Features

- Series gate resistance (R_g) <0.1 Ω
- T_r and T_f times of <10 ns
- Industry's lowest gate charge

Benefits

- Fast switching, uniform signal propagation
- Pulse power applications
- Fast switching, reduced gate drive power

BV_{DSS} (V)	$R_{DS(ON)}$ Max (Ω)	I_D (A)	MOSFET Part Number	FREDFET Part Number	Package Style
1200	4.700	3.5		APT1204R7BFLG	TO-247 or D3PAK
	1.400	9		APT1201R4BFLG	TO-247
	0.570	22	APT12057B2LLG		T-MAX®
1000	0.900	12	APT10090BLLG		TO-247
	0.780	14	APT10078BLLG		TO-247 or D3PAK
	0.450	23	APT10045B2LLG		T-MAX® or TO-264
	0.450	21	APT10045JLL		ISOTOP®
	0.350	28	APT10035B2LLG		T-MAX®
	0.350	25	APT10035JLL		ISOTOP®
	0.260	38		APT10026L2FLLG	TO-264 MAX
	0.260	30	APT10026JLL	APT10026JFLL	ISOTOP®
	0.210	37	APT10021JLL	APT10021JFLL	ISOTOP®
800	0.140	52	APT8014L2LLG	APT8014L2FLLG	TO-264 MAX
	0.110	51	APT8011JLL	APT8011JFLL	T-MAX® or TO-264
	0.200	38	APT8020B2LL		T-MAX®
	0.200	33	APT8020JLL		ISOTOP® or D3PAK
500	0.140	35	APT5014BLLG		TO-247
	0.100	46	APT5010B2LLG	APT5010B2FLLG	T-MAX® or TO-264
	0.065	67	APT50M65B2LLG	APT50M65B2FLLG	T-MAX® or TO-264
	0.065	58	APT50M65JLL	APT50M65JFLL	ISOTOP®
	0.075	51	APT50M75JLL	APT50M75JFLL	ISOTOP®
	0.075	57	APT50M75B2LLG		T-MAX® or TO-264
	0.050	71	APT50M50JLL		ISOTOP®
	0.038	88	APT50M38JLL		ISOTOP®

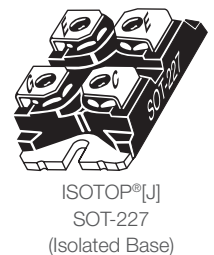
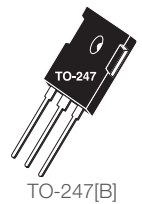

Super Junction MOSFETs

BV_{DSS} (V)	$R_{DS(ON)}$ (Ω)	$I_{D(Cont)}$ (A)	Part Number	Package Style
900	C3 Technology			
	0.120	36	APT36N90BC3G	TO-247
800	0.450	11	APT11N80BC3G	TO-247
	0.145	34	APT34N80B2C3G	T-MAX [®] or TO-264
	0.145	34	APT34N80LC3G	TO-264
650	0.035	94	APT94N65B2C3G	T-MAX [®] or TO-264
	0.070	47	APT47N65BC3G	TO-247 or D3PAK
	0.070	47	APT47N60BC3G	TO-247 or D3PAK
600	0.035	77	APT77N60JC3	ISOTOP [®]
	0.042	94	APT94N60L2C3G	264-MAX [™]
600	Server Series			
	0.045	60	APT60N60BCSG	TO-247 or D3PAK
	C6 Technology			
	0.041	77	APT77N60BC6	TO-247 or D3PAK
	0.070	53	APT53N60BC6	TO-247 or D3PAK
	0.099	38	APT38N60BC6	TO-247 or D3PAK
	0.125	30	APT30N60BC6	TO-247 or D3PAK
	0.035	106	APT106N60B2C6	T-MAX [™] or TO-264
650	0.041	85	APT97N65B2C6	T-MAX [™] or TO-264
	0.035	94	APT94N65B2C6	T-MAX [™]

Part numbers for D3PAK packages—replace “B” with “S” in part number.

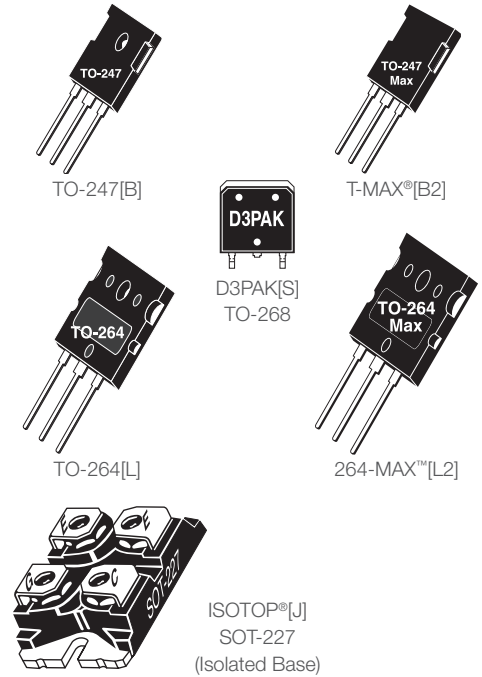

Linear MOSFETs

What is a Linear MOSFET?

A MOSFET specifically designed to be more robust than a standard MOSFET when operated with both high voltage and high current near DC conditions (>100 msecs).

The Problem with SMPS MOSFETs

MOSFETs optimized for high-frequency SMPS applications have poor high voltage DC SOA. Most SMPS-type MOSFETs over state SOA capability at high voltage on the datasheets. Above ~30 V and DC conditions, SOA drops faster than is indicated by power dissipation (PD) limited operation. For pulsed loads ($t < 10$ ms), there is generally no problem using a standard MOSFET.

Technology Innovation

Introduced in 1999, Microsemi modified its proprietary patented self-aligned metal gate MOSFET technology for enhanced performance in high voltage, linear applications.

BV_{DSS} (V)	$R_{DS(ON)}$ (Ω)	$I_{D(Cont)}$ (A)	SOA (W)	Part Number
600	0.125	49	325	APL602B2G
	0.125	43	325	APL602J
500	0.090	58	325	APL502B2G
	0.090	52	325	APL502J

Part numbers for TO-264 packages—replace “B2” with “L” in part number.

These linear MOSFETs typically provide 1.5–2.0 times the DC SOA capability at high voltage compared to other MOSFET technologies optimized for switching applications.

Designers Will Need Linear MOSFETs in the Following Situations

- High current and less than 200 volts at less than 100 milliseconds
- Used as a variable power resistor
- Soft start application (limit surge currents)
- Linear amplifier circuit

Typical Applications

- Active loads above 200 volts, such as DC dynamic loads for testing power supplies, batteries, fuel cells, and so on.
- High voltage, high current, constant current sources.

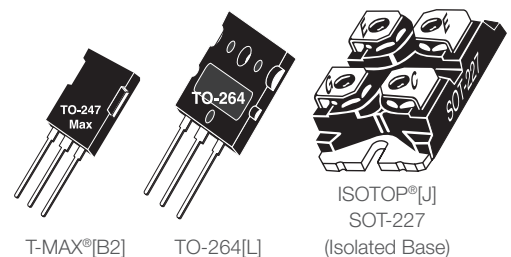

SiC Schottky Barrier Diodes

Part Number	Voltage (V)	I_F (A)	V_F (V) (Typical at 25 °C)	Package
MSC010SDA070K	700	10	1.5	TO-220
MSC030SDA070K		30	1.5	TO-220
MSC050SDA070B		50	1.5	TO-247
MSC010SDA120B	1200	10	1.5	TO-247
MSC010SDA120K		10	1.5	TO-220
MSC015SDA120B		15	1.5	TO-247
MSC030SDA120B		30	1.5	TO-247
MSC030SDA120S		30	1.5	D3PAK
MSC050SDA120B		50	1.5	TO-247
MSC050SDA120S	50	1.5	D3PAK	
MSC010SDA170B	1700	10	1.5	TO-247
MSC030SDA170B		30	1.5	TO-247
MSC050SDA170B		50	1.5	TO-247



TO-220[K]

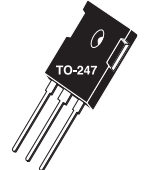

TO-247[B]



D3PAK[S]

Si Schottky Barrier Diodes, Fast and Ultra-Fast Recovery Diodes

Microsemi offers four series of discrete diode products: the medium-speed medium V_F D series, the high-speed DQ series, the silicon Schottky S series, and the SiC Schottky MSCxxxSDxxx series. These series of diodes are designed to provide high-quality solutions to a wide range of high-voltage, high-power application requirements, ranging from fast recovery for continuous conduction mode power factor correction to low conduction loss for output rectification. The following table summarizes each product family's distinguishing features and potential applications.

The following graph shows the relative recovery speed and forward voltage positions of 600 V, D, and DQ, series diodes.

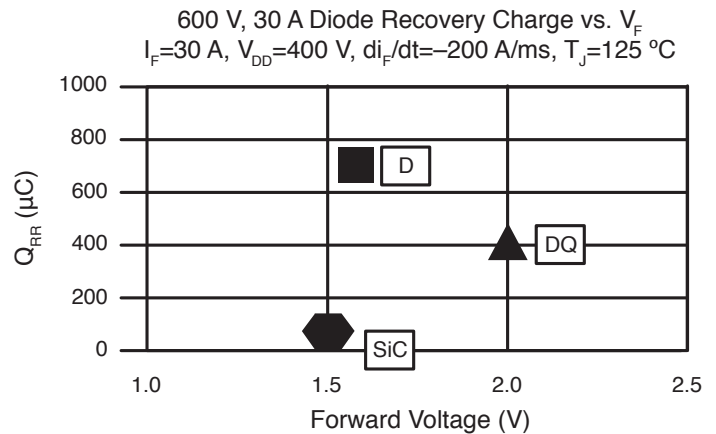

Series	Voltage Ratings	Features	Applications	Comment
D	200, 300, 400, 600, 1000, 1200	Medium V_F Medium speed	Freewheeling diode Output rectifier DC-DC converter	Proprietary platinum process
DQ	600, 1000, 1200	High speed Avalanche rated	PFC Freewheeling diode DC-DC converter	Stepped EPI improves softness Proprietary platinum process
Schottky	200	Low V_F Avalanche rated	Output rectifier Freewheeling diode DC-DC converter	
SiC Schottky	700, 1200, 1700	Zero reverse recovery	PFC Freewheeling diode DC-DC converter	Low switching losses, high power density, and high-temperature operation

Si Schottky Barrier Diodes, Fast and Ultra-Fast Recovery Diodes

Volts	I (A)	Volts Typ 25 °C	t(ns) Typ 25 °C	Q(nC) RR Typ 125 °C at I _F = I _F (avg)	Diode Series	Part Number	Package
Single							
1200	15	2.8	21	960	DQ	APT15DQ120BG	TO-247
	15	2.8	21	960	DQ	APT15DQ120KG	TO-220
	15	2.0	32	1300	D	APT15D120BG	TO-247
	15	2.0	32	1300	D	APT15D120KG	TO-220
	30	2.8	24	1800	DQ	APT30DQ120BG	TO-247
	30	2.8	24	1800	DQ	APT30DQ120KG	TO-220
	30	2.0	31	3450	D	APT30D120BG	TO-247
	40	2.8	26	2200	DQ	APT40DQ120BG	TO-247
	60	2.8	30	2800	DQ	APT60DQ120BG	TO-247
	60	2.0	38	4000	D	APT60D120BG	TO-247 or D3PAK
	75	2.8	32	3340	DQ	APT75DQ120BG	TO-247
1000	15	2.5	20	810	DQ	APT15DQ100BG	TO-247
	15	2.5	20	810	DQ	APT15DQ100KG	TO-220
	15	1.9	28	1550	D	APT15D100KG	TO-220
	30	2.5	22	1250	DQ	APT30DQ100BG	TO-247
	30	2.5	22	1250	DQ	APT30DQ100KG	TO-247
	30	1.9	29	2350	D	APT30D100BG	TO-247
	40	2.5	24	1430	DQ	APT40DQ100BG	TO-247
	60	2.5	29	2325	DQ	APT60DQ100BG	TO-247
	60	1.9	34	3600	D	APT60D100BG	TO-247 or D3PAK
600	15	2.0	16	250	DQ	APT15DQ60BG	TO-247
	15	2.0	16	250	DQ	APT15DQ60KG	TO-220
	15	1.6	21	520	D	APT15D60BG	TO-247
	15	1.6	21	520	D	APT15D60KG	TO-220
	30	2.0	19	400	DQ	APT30DQ60BG	TO-247
	30	2.0	19	400	DQ	APT30DQ60KG	TO-220
	30	1.6	23	700	D	APT30D60BG	TO-247
	40	2.0	22	480	DQ	APT40DQ60BG	TO-247
	60	2.0	26	640	DQ	APT60DQ60BG	TO-247
	60	1.6	40	920	D	APT60D60BG	TO-247 or D3PAK
	75	2.0	29	650	DQ	APT75DQ60BG	TO-247
400	30	1.3	22	360	D	APT30D40BG	TO-247
	60	1.3	30	540	D	APT60D40BG	TO-247
200	30	1.1	21	150	D	APT30D20BG	TO-247
	30	0.83	25	448	Schottky	APT30S20BG	TO-247 or D3PAK
	60	1.1	30	250	D	APT60D20BG	TO-247
	60	0.83	35	490	Schottky	APT60S20BG	TO-247 or D3PAK
	100	0.89	40	690	Schottky	APT100S20BG	TO-247

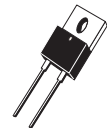

TO-220[K]



D3PAK[S]
TO-268

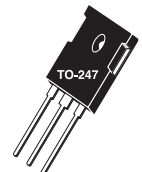

TO-247[B]



T-MAX®[B2]

Part numbers for D3 package—replace "B" with "S" in part number.

Si Schottky Barrier Diodes, Fast and Ultra-Fast Recovery Diodes

Volts	I (A)	Volts Typ 25 °C	t(ns) Typ 25 °C	Q(nC) RR Typ 125 °C at I _F = I _F (avg)	Diode Series	Part Number	Package
Dual							
1200	2x27	2	31	3450	D	APT2X30D120J	ISOTOP®
	2x30	2.6	25	1800	DQ	APT2X30DQ120J	
	2x53	2.0	38	4000	D	APT2X60D120J	
	2x60	2.5	30	2890	DQ	APT2X60DQ120J	
	2x93	2.0	47	5350	D	APT2X100D120J	
	2x100	2.4	45	5240	DQ	APT2X100DQ120J	
1000	2x28	1.9	29	2350	D	APT2X30D100J	
	2x55	1.9	34	3600	D	APT2X60D100J	
	2x60	2.2	30	2350	DQ	APT2X60DQ100J	
	2x95	1.9	43	4050	D	APT2X100D100J	
	2x100	2.1	45	3645	DQ	APT2X100DQ100J	
600	2x30	1.8	20	400	DQ	APT2X30DQ60J	
	2x30	1.6	23	700	D	APT2X30D60J	
	2x60	1.7	27	650	DQ	APT2X60DQ60J	
	2x60	1.6	40	920	D	APT2X60D60J	
	2x100	1.6	30	980	DQ	APT2X100DQ60J	
	2x100	1.6	34	1450	D	APT2X100D60J	
400	2x30	1.3	22	360	D	APT2X30D40J	
	2x60	1.3	30	540	D	APT2X60D40J	
	2x100	1.3	37	1050	D	APT2X100D40J	
300	2x100	1.2	36	650	D	APT2X101D30J	
200	2x30	0.80	25	448	Schottky	APT2X31S20J	
	2x60	0.83	35	490	Schottky	APT2X61S20J	
	2x100	1.1	39	840	D	APT2X100D20J	
	2x100	0.89	40	690	Schottky	APT2X101S20J	
1200	2x30	2.8	26	2100	DQ	APT30DQ120BCTG	TO-247 [BCT]
1000	2x15	2.5	20	810	DQ	APT15DQ100BCTG	TO-247 [BCT]
	2x15	1.9	28	1550	D	APT15D100BCTG	TO-247 [BHB]
	2x30	1.9	29	2360	D	APT30D100BCTG	TO-247 [BHB]
	2x30	1.9	30	2350	D	APT30D100BHBG	TO-247 [BCA]
	2x60	2.5	29	2325	DQ	APT60DQ100LCTG	TO-264 [LCT]
600	2x60	1.9	35	3600	D	APT60D100LCTG	TO-264 [LCT]
	2x15	1.6	21	520	D	APT15D60BCTG	TO-247
	2x15	2.0	15	250	DQ	APT15DQ60BCTG	TO-247 [BCT]
	2x15	1.6	20	520	D	APT15D60BCAG	TO-247 [BCA]
	2x30	2.0	22	480	DQ	APT30DQ60BHBG	TO-247 [BHB]
	2x30	2.0	19	400	DQ	APT30DQ60BCTG	TO-247 [BCT]
	2x30	1.6	23	700	D	APT30D60BCTG	TO-247 [BCT]
	2x30	1.6	25	700	D	APT30D60BHBG	TO-247 [BHB]
	2x30	1.6	25	700	D	APT30D60BCAG	TO-247 [BCA]
	2x40	2.0	22	480	DQ	APT40DQ60BCTG	TO-247 [BCT]
	2x60	2.0	26	640	DQ	APT60DQ60BCTG	TO-247 [BCT]
	2x60	1.6	30	920	D	APT60D60LCTG	TO-264 [LCT]
	400	2x30	1.3	22	360	D	APT30D40BCTG
	2x60	1.3	30	540	D	APT60D40LCTG	TO-264 [LCT]
300	2x30	1.2	25	1300	D	APT30D30BCTG	TO-247 [BCT]
200	2x30	1.1	21	150	D	APT30D20BCTG	TO-247 [BCT]
	2x30	1.1	21	150	D	APT30D20BCAG	TO-247 [BCA]
	2x30	0.80	25	448	Schottky	APT30S20BCTG	TO-247 [BCT]
	2x60	0.83	35	490	Schottky	APT60S20B2CTG	T-MAX® [B2CT]
	2x100	0.89	40	690	Schottky	APT100S20LCTG	TO-264 [LCT]



ISOTOP®[J] SOT-227
Antiparallel
Configuration
(Isolated Base)

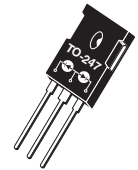
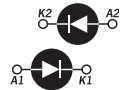

TO-247[BCA]
Common anode

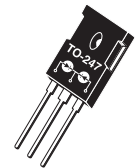

TO-247[BCT]
Common cathode

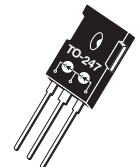

TO-247[BHB]
Half-bridge

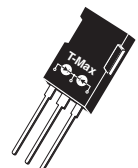

T-MAX® [B2CT]
Common cathode

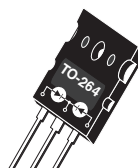

TO-264[LCT]
Common cathode

Part numbers for parallel configuration: replace 30, 60, or 100 with 31, 61, or 101, unless Schottky. Example: 2X30D120J becomes 2X31D120J. Part numbers for D3PAK packages—replace "B" with "S" in part number.

High-Voltage RF MOSFETs

The ARF family of RF power MOSFETs is optimized for applications requiring frequencies as high as 150 MHz and operating voltages as high as 400 V. Historically, RF power MOSFETs were limited to applications of 50 V or less. This limitation has been removed by combining Microsemi's high-voltage MOSFET technology with RF-specific die geometries.

Why higher voltage? Higher V_{DD} means higher load impedance. For 150 W output from a 50 V supply, the load impedance is only 8 Ω . At 125 V, the load impedance is 50 Ω . The higher

impedance allows simpler transformers and combiners. Paralleled devices can still operate into reasonable and convenient impedances. The increased operating voltage also lowers the DC current required for any given power output, increasing efficiency and reducing the size, weight, and cost of other system components. High breakdown voltage is a necessity in high-efficiency switchmode amplifiers, such as class C-E, which can see peak drain voltages of over 4x the applied V_{DD} .

Part Number	P_{OUT} (W)	Freq. (MHz)	V_{DD}/B_{VDSS} (V)	R_{thJC} (OC/W)	Package Style	Class of Operation
ARF449AG/BG	90	120	150/450	0.76	TO-247	A-E
ARF463AG/BG	100	100	125/500	0.7	TO-247	A-E
ARF463AP1G/BP1G	100	100	125/500	0.7	TO-247	A-E
ARF446G/ARF447G	140	65	250/900	0.55	TO-247	A-E
ARF521	150	150	165/500	0.6	M174	A-E
ARF460AG/BG	150	65	125/500	0.5	TO-247	A-E
ARF461AG/BG	150	65	250/1000	0.5	TO-247	A-E
ARF465AG/BG	150	60	300/1200	0.5	TO-247	A-E
ARF468AG/BG	270	45	165/500	0.38	TO-264	A-E
ARF475FL	300	150	165/500	0.31	T3A	A-E
ARF476FL	300	150	165/500	0.31	T3	A-E
ARF466AG/BG	300	45	200/1000	0.35	TO-264	A-E
ARF466FL	300	45	200/1000	0.13	T3A	A-E
ARF479	300	150	165/500	0.31	T3C	A-E
ARF469AG/BG	350	45	165/500	0.28	TO-264	A-E
ARF477FL	400	65	165/500	0.18	T3A	A-E
ARF1500	750	40	125/500	0.12	T1	A-E
ARF1501	750	40	250/1000	0.12	T1	A-E
ARF1510	750	40	700/1000	0.12	T1	D
ARF1511	750	40	380/500	0.12	T1	D
ARF1519	750	25	250/1000	0.13	T2	A-E

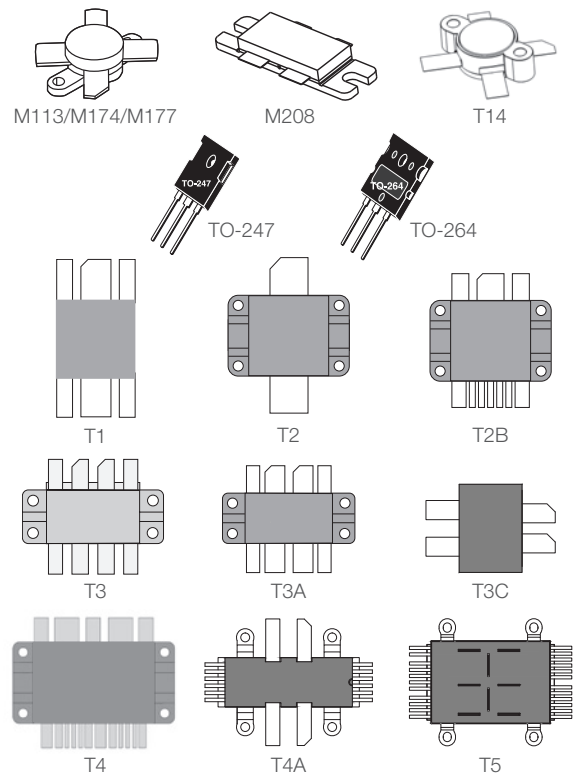

High-Frequency RF MOSFETs

The VRF family of RF MOSFETs includes improved replacements for industry-standard RF transistors. They provide improved ruggedness by increasing the B_{VDSS} over 30 percent from the industry-standard 125 V to 170 V minimum. Low-cost flangeless packages are another improvement that shows Microsemi's dedication to optimizing performance, reducing cost, and improving reliability. We will continue to offer more products with the new reduced-cost flangeless packages.

Part Number	P_{OUT} (W)	Freq. (MHz)	Gain Typ (dB)	Eff. Typ (%)	V_{DD}/B_{VDSS} (V)	R_{thJC} (OC/W)	Package Style
VRF148A	30	175	16	50	65/170	1.52	M113
VRF141	150	175	13	45	28/80	0.60	M174
VRF151	150	175	14	50	65/170	0.60	M174
VRF152	150	175	14	50	50/140	0.60	M174
VRF150	150	150	11	50	65/170	0.60	M174
VRF161	200	175	25	50	65/170	0.50	M177
VRF151G	300	175	16	55	65/170	0.30	M208
VRF2933	300	150	25	50	65/170	0.27	M177
VRF2944	400	150	25	50	65/170	0.22	M177
VRF154FL	600	30	17	45	65/170	0.13	T2
VRF157FL	600	30	21	45	65/170	0.13	T2
VRF164FL	600	30	21	45	65/170	0.10	T2

Drivers and Driver-RF MOSFET Hybrids

The DRF1200/01 hybrids integrate drivers, bypass capacitors, and RF MOSFETs into a single package. Integration maximizes amplifier performance by minimizing transmission line parasitics between the driver and the MOSFET. The DRF1300 and DRF1301 have two independent channels, each containing a driver and RF MOSFET in a push-pull configuration. The DRF1400 is a half-bridge hybrid with symmetrically oriented

leads that can be easily configured into a full-bridge converter. The new DRF1510 is a full bridge product optimized for maximum efficiency in class D amplifiers. All DRF parts feature a proprietary anti-ringing function to eliminate cross conduction in bridge or push-pull topologies. All DRF parts can be externally selected in either an inverting or non-inverting configuration.

Part Number	P _{OUT} (W)	Freq. (MHz)	V _{DD} /B _{VDS} (V)	Package Style	Class of Operation
DRF1200	400	30	15/1000	T2B	D-E
DRF1201	600	30	15/1000	T2B	D-E
DRF1300	1000	30	15/500	T4	D-E
DRF1301	1000	30	15/1000	T4	D-E
DRF1400	1000	30	15/500	T4	D-E
DRF1211	600	30	15/500	T2B	D-E
DRF1410	1000	30	15/500	T4A	D-E
DRF1510	2000	30	15/500	T5	D-E

Reference Design Kits

All kits include a fully populated board attached to an aluminum heat sink, an extensive application note explaining the theory of operation with designer's recommendations for evaluation and board layout, and all key waveforms illustrated and described. A complete parts list with recommended vendor part numbers and the board's Gerber file are provided for an easy transition into an end application.

DRF1200/CLASS-E, 13.56 MHz DRF1200/CLASS-E, 27.12 MHz

The DRF1200/Class-E single-ended RF generator is a reference design that allows the designer to evaluate an 85 percent efficient 1000 W Class-E RF generator.

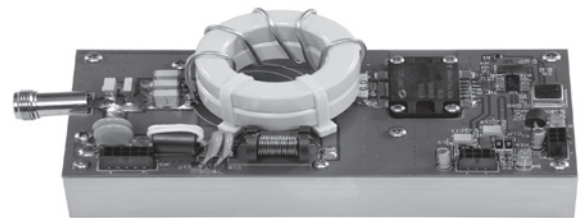

DRF1300/CLASS-D, 13.56 MHz

The DRF1300/Class-D push-pull RF generator is a reference design that allows the designer to evaluate an 80-percent efficient 2000 W Class-D RF generator.

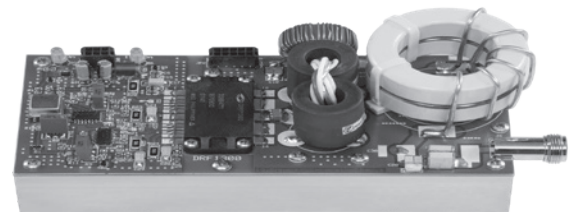

DRF1400/Class-D, 13.56 MHz

The DRF1400/Class-D half-bridge RF generator is a reference design that allows the designer to evaluate an 85-percent efficient 2500 W Class-D RF generator.

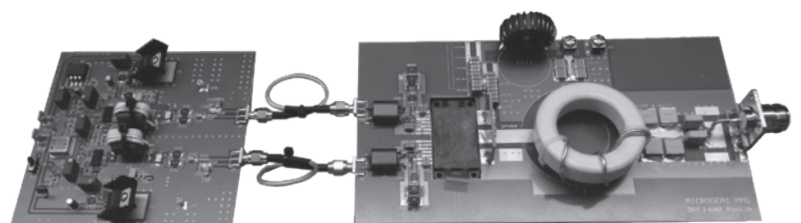

New DRF1410 and DRF1510 Reference Designs Coming Soon

Power Modules Contents

IGBT Power Modules	
Power Module Information	18–22
Chopper and Phase Leg	23
3-Phase Bridge	24
Triple Phase Leg.	24
Triple Dual Common Source.	24
Dual Chopper.	24
Full and Asymmetrical Bridge.	25
Single Switch	26
Single Switch + Series Diode	26
Dual Common Source	26
Intelligent Power Modules	
Phase Leg	26
MOSFET Power Modules	
Boost and Buck Chopper	27
Dual Chopper.	27
Full Bridge	28
Full Bridge + Series and Parallel Diodes	28
Asymmetrical Bridge	28
Phase Leg	29
Phase Leg + Series and Parallel Diodes	29
Phase Leg + Series Diodes	29
Triple Phase Leg.	29
Triple Dual Common Source.	30
Dual Common Source	30
Single Switch	30
Single Switch + Series Diode	30
Single Switch + Series and Parallel Diodes.	30
Interleaved PFC	30
Single and Dual Linear MOSFET	31
Renewable Energy Power Modules	
Full Bridge	31
PFC + Bypass Diode + Phase Leg.	31
PFC + Full Bridge.	31
PFC + Bypass Diode + Full Bridge.	31
Secondary Fast Rectifier + Full Bridge	31
Boost Buck	32
3-Level NPC Inverter	32
T-Type 3-Level Inverter	32
SiC Diode Power Modules	
Dual Diode.	33
Full Bridge	33
IGBT + SiC Diode Power Modules	
Boost Chopper	33
Dual Chopper.	33
MOSFET + SiC Diode Power Modules	
Single Switch + Series FRED and SiC Parallel Diodes	34
Chopper	34
Phase Leg + Series FRED and SiC Parallel Diodes.	34
Full Bridge + Series FRED and SiC Parallel Diodes.	34
Triple Phase Leg.	34
SiC MOSFET Power Modules	
T-Type 3-Level Inverter	35
3-Level NPC Inverter	35
Phase Leg	35
Phase Leg: Very Low Inductance Package.	35
Triple Phase Leg.	35
Boost Chopper	35
Full Bridge	35
Diode Power Modules	
Single Diode.	36
3-Phase Bridge	36
Full Bridge	36
Common Cathode–Common Anode–Doublor	36
Package Outline Drawings	37–40

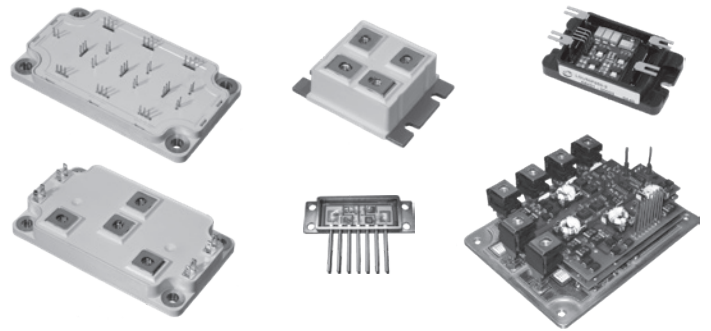

Microsemi combines a formidable array of technologies in semiconductors, packaging, and automated manufacturing to produce a wide range of high-quality modules optimized for the following traits:

- Reliability
- Efficiency and electrical performance
- Low cost
- Space savings
- Reduced assembly time

The readily available standard module product line spans a wide selection of semiconductor (including Silicon Carbide) circuit topologies, voltage and current ratings, and packages. If you need even more flexibility or intellectual property protection, Microsemi can customize a standard module with a low setup cost and short lead time. Unique requirements can be met with application specific power modules (ASPM).

Microsemi serves a broad spectrum of industrial applications for welding, solar, induction heating, medical, UPS, motor control, and SMPS markets as well as high-reliability applications for semicap, defense, and aerospace markets. A wide selection of construction materials enables Microsemi to manufacture modules with the following features:

- Extended temperature range: –60 °C to 200 °C
- High reliability
- Reduced size and weight
- High-reliability testing and screening options
- Short lead times

Microsemi’s experience and expertise in power electronic conversion brings the most effective technical support for your new development.

- Isolated gate driver
- Snubbers
- Mix-and-match semiconductors
- Short-circuit protection
- Temperature and current sensing
- Parameter binning

Standard Electrical Configurations

Microsemi offers a wide range of standard electrical configurations housed in a variety of packages to match your specific needs for high power-density and performance. Various semiconductor types are offered in the same topology.

Electrical Topology	IGBT 600 V–1700 V	MOSFET 75 V–1200 V	Diode 200 V–1700 V	Mix Si-SiC 600 V–1200 V	Full SiC 600 to 1700V
Asymmetrical bridge	•	•			
Boost buck	•	•			
Boost and buck chopper	•	•		•	•
Common anode			•		
Common cathode			•		
Dual boost and buck chopper	•	•		•	
Dual common source	•	•			
Dual diode					•
Full bridge	•	•	•		•
Full bridge with PFC	•	•		•	
Full bridge with secondary fast rectifier bridge	•	•		•	
Full bridge with series and parallel diodes		•		•	
Interleaved PFC	•	•			
Linear single and dual switch		•			
Phase leg	•	•	•		•
Phase leg intelligent	•				
Phase leg with PFC		•		•	
Phase leg with series and parallel diodes		•		•	
Single switch	•	•	•		
Single switch with series and parallel diodes		•		•	
Single switch with series diodes	•	•			
3-Level NPC inverter	•				•
3-Level T-Type inverter	•			•	•
3-Phase bridge	•		•		
Triple dual common source	•	•			
Triple phase leg	•	•		•	•

Trench3	MOSFET	FRED	IGBT	Diode
Trench4	FREDFET	Std Rectifier	MOSFET	MOSFET
Trench4 Fast	Super Junction Mosfet		Diode	
Trench5				

Packaging

Improved Low-Profile Packages

SP1 (12 mm)

SP3F (12 mm)

SP4 (17 mm)

SP6 (17 mm)

SP6-P (12 mm)

SP6LI (17 mm)



Industry-Standard Packages

SOT-227 (ISOTOP®)

SP2 (17 mm)

D3 (62 mm wide)

D4 (62 mm wide)

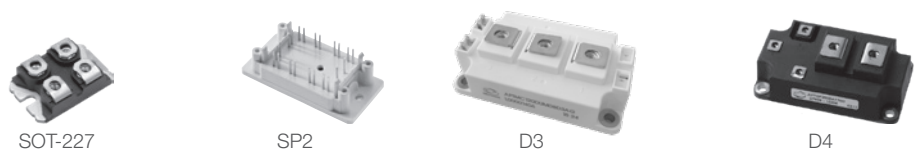

Package Advantages

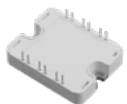
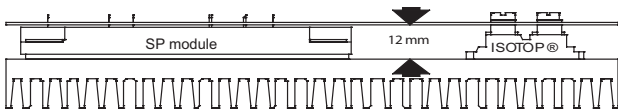

SP1 package:

- Replaces two SOT-227 parts
- Improved assembly time and cost
- Height compatible with SOT-227
- Copper base plate



SP3F package:

- Replaces up to four SOT-227 parts
- Reduced assembly time and cost
- Height compatible with SOT-227
- Copper base plate



30 mm

SP6 package:

Offers the same footprint and the same pinout location as the popular 62 mm package but with lower height, giving it the following advantages:

- Reduced stray inductance
- Reduced parasitic resistance
- Higher efficiency at high frequency



17 mm

SP6-P package:

- Replaces up to six SOT-227 parts
- Height compatible with SOT-227
- Low-inductance solder pins
- High current capability



Custom Power Modules

Microsemi created the application specific power module (ASPM) concept, and has been offering customized power modules since 1983. Microsemi offers a complete engineered solution with mix-and-match capabilities in term of package, configuration, performance, and cost.

Internal Printed Circuit Board

- Not available in all modules.
- Used to route gate signals' tracks to small signal terminals.
- Used to mount gate circuit and protection in case of intelligent power module.

Terminals

- Screw-on or solder pins.
- Provides power and signal connections with minimum parasitic resistance and inductance.

Substrates

- Al_2O_3 , AlN, and Si_3N_4 provide isolation and good heat transfer to the base plate.

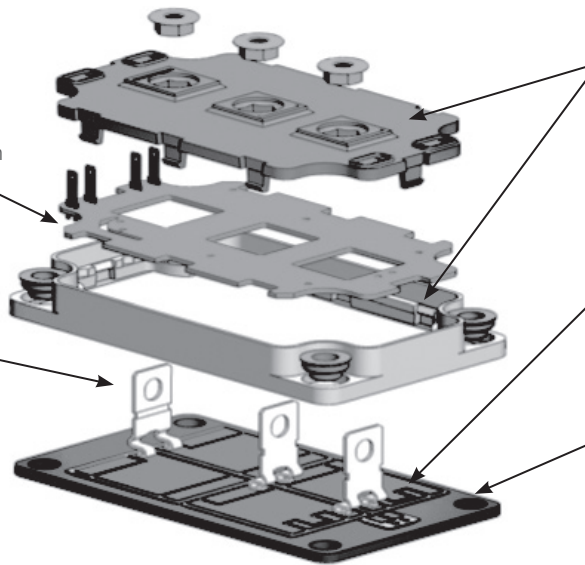

Package

- Standard or custom.
- Ensures environmental protection and mechanical robustness.

Power Semiconductor Die

- IGBT, MOSFET, diode, SiC, thyristor and switching devices soldered to the substrates and connected by ultrasonic aluminum wire bonds.

Base Plate

- Improves the heat transfer to the heat sink.
- Copper for good thermal transfer.
- AlSiC, CuW, and CuMoCu for improved reliability.

The following table shows the three customization levels.

Change Options:	Die	Substrate	Base Plate	Plastic Lid	Terminals	NRE Level	MOQ
Electrical/thermal performance	Die P/N	Material	Material			None to low	5 to 10 pieces
Electrical/thermal performance and electrical configuration	Die P/N	Material and layout	Material			Low to medium	
Electrical/thermal performance, and electrical configuration, and module housing	Die P/N	Material and layout	Material and shape	Material and shape	Shape	Medium to high	

Microsemi power modules are made of different sub-elements. Most of them are standard and can be reused to build infinite solutions for the end user. Microsemi offers optimum development cost and cycle time thanks to long-term experience and a wide range of available technologies.

Power Modules Features

- High power density
- Isolated and highly thermally-conductive substrate
- Internal wiring
- Minimum parasitics
- Minimum output terminals
- Mix-and-match components
- Fully engineered solutions

Customer Benefits

- Size and cost reduction
- Excellent thermal management
- Reduced external hardware
- Improved performance
- Reduced assembly time
- Optimizes losses
- Easy to upgrade, lower part count, shorter time to market, and IP protection

Flexibility

- Great level of integration
- Mix of silicon within the same package
- No quantity limitation

Technology

- Application oriented

Packaging Capability

- Standard and custom packages
- Standard and custom terminals
- Various substrate technologies

Reliability

- Coefficient of thermal expansion matching

Applications

- Solar, welding, plasma cutting, semicap, MRI and X-ray, EV/HEV, induction heating, UPS, motor control, data communication

Rugged Custom Power Modules

Microsemi has acquired much experience and know-how in module customization that addresses rugged and wide temperature range applications, offering solutions to meet the expectations of next-generation integrated power systems for the following attributes:

- Improved reliability
- Wider operating temperatures
- Higher power
- Higher efficiency
- Lower weight and size
- Lower cost

Applications

- Avionics actuation system
- Avionics lift and pump
- Military ground vehicle
- Power supply and motor control
- Navy ship auxiliary power supply
- Down hole drilling

Test Capabilities

- X-Ray inspection
- Dielectric test (up to 6 kV)
- Electrical testing at specified temperature
- Burn-in
- Acoustic imaging

Reliability Testing Capabilities

- Power cycling
- Hermetic sealing
- Moisture
- Salt atmosphere
- HTGB
- Temperature shock
- HAST
- H3TRB
- Altitude
- Mechanical shock, vibration

Expertise Capabilities

- Cross-sectioning
- Structural analysis

All tests can be conducted upon demand by sampling or at 100 percent. Tests can be performed in-house or in an external lab.

Our Core Competencies

- Extensive experience with rugged solutions for harsh environments
- Wide range of silicon technologies
- Wafer fab capabilities
- Mix of assembly technologies
- Hermetic and robust plastic packages
- Custom test and burn-in solutions
- ISO9001-certified
- End-of-life (obsolescence) management
- Thermal management
- Material expertise
- Product life management and risk analysis

Various proposed solutions offer different costs and low volume of entry

	Industrial Application	Extended Temp. Application	Harsh Environment Application	
Standard module	•			No NRE Low-volume entry
Modified standard	•	•		Low NRE Low-volume entry
Custom module	•	•	•	Medium to high NRE Low-volume entry

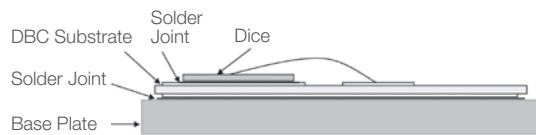

	CTE (ppm/K)	Thermal Conductivity (W/m.K)	$R_{\theta JC}$ or $R_{\theta JWC}$ (K/W)
Silicon die (120 mm ²)	4	136	
Cu/Al ₂ O ₃	17/7	390/25	0.35
AlSiC/Al ₂ O ₃	7/7	170/25	0.38
Cu/AlN	17/5	390/170	0.28
AlSiC/AlN	7/5	170/170	0.31
AlSiC/Si ₃ N ₄	7/3	170/60	0.31

	Material	CTE (ppm/K) (W/m.K)	Thermal Conductivity	Density (g/cc)
Base plate	CuW	6.5	190	17
	AlSiC	7	170	2.9
	Cu	17	390	8.9
Substrate	Al ₂ O ₃	7	25	
	AlN	5	170	
	Si ₃ N ₄	3	60	
Die	Si	4	136	
	SiC	2.6	270	

Module performance and reliability depends on the choice of assembly materials

Temperature coefficients of expansion (TCEs) with more closely matched materials increase the module's lifetime by reducing the stress at both the interface and interior of the materials.

The higher the thermal conductivity, the lower the junction-to-case thermal resistance and the lower the delta of junction temperature of the device during operation. This will minimize the effect of power cycling on the dice.

Another important feature is the material density, particularly for the baseplate. Taking copper as the reference, AlSiC has a density of 1/3, while CuW has twice the density. Therefore, AlSiC will provide substantial weight reduction while increasing reliability.



Power Module Part Numbering System

IGBT Modules

APT MSC	GL	475	A	120	T	D3	G
I	II	III	IV	V	VI	VII	VIII

I TradeMark

IGBT Type:

GL = TRENCH 4
 GLQ = High-speed TRENCH 4
 GT = TRENCH 3
 GTQ = TRENCH 5
 GV = Mix NPT/TRENCH
 CV = Mix TRENCH/Super Junction MOSFET

Current:

I_c at $T_c = 80^\circ\text{C}$

Topology:

A = Phase Leg
 BB = Boost Buck
 DA = Boost Chopper
 DDA = Double Boost Chopper
 DH = Asymmetrical Bridge
 DSK = Double Buck Chopper
 DU = Dual Common Source
 H = Full Bridge
 HR = T-Type 3-Level
 SDA = Double Boost + Bypass Diode
 SK = Buck Chopper
 TA = Triple Phase Leg
 TDU = Triple Dual Common Source
 TL = Three Level
 U = Single Switch
 VDA = Interleaved PFC
 X = Three Phase Bridge

Blocking Voltage:

60 = 600 V
 120 = 1200 V
 170 = 1700 V

Option:

A = AlN Substrate
 C = SiC Diode
 D = Series Diode
 T = Temperature Sensor
 W = Clamping Parallel Diode

Package:

1 = SP1
 2 = SP2
 3 = SP3F
 P = SP6-P
 D3 = D3 (62 mm)
 D4 = D4 (62 mm)

VIII G = RoHS-compliant

MOSFET Modules

APT MSC	C	60	DA	M24	T	1	G
I	II	III	IV	V	VI	VII	VIII

I TradeMark

MOSFET Type:

MC - SM = MOSFET SiC
 M = MOSFET
 C = Super Junction MOSFET

Blocking Voltage:

08 = 75 V 80 = 800 V
 10 = 100 V 90 = 900 V
 20 = 200 V 100 = 100 V
 50 = 500 V 120 = 120 V
 60 = 600 V

Topology:

A = Phase Leg
 BB = Boost Buck
 DA = Boost Chopper
 DDA = Double Boost Chopper
 DH = Asymmetrical Bridge
 DSK = Double Buck Chopper
 DU = Dual Common Source
 H = Full Bridge
 HR = T-Type 3-Level
 SDA = Double Boost and Bypass Diode
 SK = Buck Chopper
 TA = Triple Phase Leg
 TDU = Triple Dual Common Source
 TL = Three Level NPC
 U = Single Switch
 VDA = Interleaved PFC

RDSON at $T_c = 25^\circ\text{C}$

240 = 2400 m Ω
 24 = 240 m Ω
 M24 = 24 m Ω

Option:

A = AlN Substrate
 C = SiC Diode
 D = Series Diode
 F = FREDFET
 S = Series and Parallel Diodes
 T = Temperature Sensor
 U = Ultra-fast FREDFET

Package:

1 = SP1
 2 = SP2
 3 = SP3F
 P = SP6-P
 LI = SP6LI

VIII G = RoHS-compliant

Diode Modules

APT MSC	DR	90	X	160	1	G
I	II	III	IV	V	VI	VII

I TradeMark

Diode Type:

DF = FRED
 DR = Standard Rectifier
 DC = SiC
 DSK = Schottky

Current:

I_F at $T_c = 80^\circ\text{C}$

Topology:

AA = Dual Common Anode
 BB = Boost Buck
 AK = Dual Series
 KK = Dual Common Cathode
 H = Single Phase Bridge
 U = Single Switch
 X = Three Phase Bridge

Blocking Voltage:

20 = 200 V
 40 = 400 V
 60 = 600 V
 100 = 1000 V
 120 = 1200 V
 160 = 1600 V
 170 = 1700 V

Package:

1 = SP1
 3 = SP3F

VII G = RoHS-compliant

Optional Materials

Optional materials are available upon demand for most of the listed standard power modules. Options are indicated with a letter in the suffix of the module part number. The temperature sensor option is listed as "YES" or "OPTION" when available for a standard part or on-demand.

The following tables list the options available for our product categories.

- A** AlN substrate for higher thermal conductivity
- M** AlSiC base plate material for improved temperature cycling capabilities
- T** Temperature sensor (NTC or PTC) for case temperature information
- C** SiC diode for higher efficiency
- N** Si_3N_4 substrate
- E** Press fit terminals (for SP3F package only)
- X** Gold pin terminals (SP1 only)
- L** Phase change material option

IGBT Power Modules

Chopper and Phase Leg

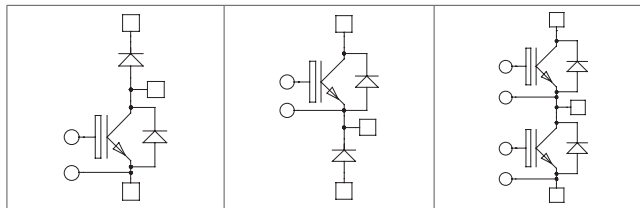

$V_{(BR)CES}$ (V)	IGBT Type	I_c (A) $T_c = 80^\circ C$	$V_{CE(on)}$ (V) at Rated I_c	Package	NTC	...DA... or ...U2	...SK... or ...U3	...A...
600	Trench 3	75	1.5	SP1	Yes	APTGT75DA60T1G		APTGT75A60T1G
		100	1.5	SP1	Yes	APTGT100DA60T1G		APTGT100A60T1G
		150	1.5	SP1	Yes	APTGT150DA60T1G	APTGT150SK60T1G	APTGT150A60T1G
		150	1.5	SP3F	Yes			APTGT150A60T3AG
		200	1.5	SP2	No			APTGT200A60T2G
		200	1.5	SP3F	Yes	APTGT200DA60T3AG	APTGT200SK60T3AG	APTGT200A60T3AG
		300	1.5	SP4	Yes			APTGT300A60T4G
		300	1.5	SP6	Option	APTGT300DA60G	APTGT300SK60G	APTGT300A60G
		300	1.5	D3	Option	APTGT300DA60D3G	APTGT300SK60D3G	APTGT300A60D3G
		400	1.5	D3	Option	APTGT400DA60D3G		APTGT400A60D3G
650	Trench 4 Fast	50	1.85	SOT-227	No	APT50GLQ65JU2	APT100GLQ65JU3	
		50	1.85	SOT-227	No			APTGLQ100A65T1G
		100	1.85	SP1	Yes			APTGLQ600A65T6G
		600	1.85	SP6	Yes			
650	Trench 5	60	1.65	SP1	Yes	APTGTQ100DA65T1G	APTGTQ100SK65T1G	APTGTQ100A65T1G
		120	1.65	SP3F	Yes	APTGTQ200DA65T3G	APTGTQ200SK65T3G	APTGTQ200A65T3G
1200	Trench 3	35	1.7	SP1	Yes			APTGT35A120T1G
		35	1.7	SOT-227	No	APT35GT120JU2	APT35GT120JU3	
		50	1.7	SOT-227	No	APT50GT120JU2	APT50GT120JU3	
		50	1.7	SP1	Yes			APTGT50A120T1G
		50	1.7	SP4	Yes	APTGT50DA120TG	APTGT50SK120TG	
		75	1.7	SOT-227	No	APT75GT120JU2	APT75GT120JU3	
		75	1.7	SP1	Yes			APTGT75A120T1G
		75	1.7	SP4	Yes	APTGT75DA120TG	APTGT75SK120TG	
		100	1.7	SP1	Yes	APTGT100DA120T1G		
		100	1.7	SOT-227	No	APT100GT120JU2	APT100GT120JU3	
		100	1.7	SP3F	Yes			APTGT100A120T3AG
		100	1.7	SP4	Yes			APTGT100A120TG
		150	1.7	SP6	Option	APTGT150DA120G	APTGT150SK120G	APTGT150A120G
		150	1.7	SP3F	Yes			APTGT150A120T3AG
		150	1.7	SP4	Yes			APTGT150A120TG
		200	1.7	SP6	Option	APTGT200DA120G	APTGT200SK120G	APTGT200A120G
		200	1.7	D3	Option	APTGT200DA120D3G		APTGT200A120D3G
		300	1.7	SP6	Option	APTGT300DA120G	APTGT300SK120G	APTGT300A120G
300	1.7	D3	Option			APTGT300A120D3G		
400	1.7	SP6	Option	APTGT400DA120G	APTGT400SK120G	APTGT400A120G		
400	1.7	D3	Option			APTGT400A120D3G		
1200	Trench 4	40	1.85	SOT-227	No	APT40GL120JU2	APT40GL120JU3	
		90	1.85	SP1	Yes	APTGL90DA120T1G		APTGL90A120T1G
		180	1.85	SP2	No			APTGL180A120T2G
		180	1.85	SP3F	Yes			APTGL180A120T3AG
		325	1.85	D3	Option			APTGL325A120D3G
		475	1.85	D3	Option	APTGL475DA120D3G	APTGL475SK120D3G	APTGL475A120D3G
	Trench 4 Fast	700	1.85	D3	Option	APTGL700DA120D3G	APTGL700SK120D3G	
		100	2.05	SP3F	Yes			APTGLQ100A120T3AG
		100	2.05	SP1	Yes	APTGLQ100DA120T1G		
		100	2.05	SP4	Yes			APTGLQ100A120TG
150	2.05	SP4	Yes			APTGLQ150A120TG		
200	2.05	SP3F	Yes			APTGLQ200A120T3AG		
300	2.05	SP6C	No		APTGLQ300SK120G	APTGLQ300A120G		
400	2.05	SP6	Yes			APTGLQ400A120T6G		
1700	Trench 3	30	2	SP1	Yes			APTGT30A170T1G
		50	2	SP1	Yes		APTGT50SK170T1G	APTGT50A170T1G
		50	2	SP4	Yes		APTGT50SK170TG	APTGT50A170TG
		100	2	SP4	Yes		APTGT100SK170TG	APTGT100A170TG
		150	2	SP6	Option		APTGT150SK170G	
		200	2	D3	Option			APTGT200A170D3G
		225	2	SP6	Option	APTGT225DA170G	APTGT225SK170G	APTGT225A170G
		300	2	SP6	Option	APTGT300DA170G	APTGT300SK170G	APTGT300A170G
300	2	D3	Option	APTGT300DA170D3G		APTGT300A170D3G		

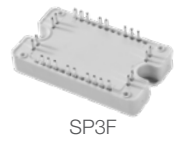

IGBT Power Modules (continued)

Three-Phase Bridge

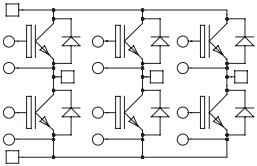

$V_{(BR)CES}$ (V)	IGBT Type	I_c (A) $T_c = 80\text{ }^\circ\text{C}$	$V_{CE(on)}$ (V) at Rated I_c	Package	NTC	Part Number
600	Trench 3	30	1.5	SP3F	Yes	APTGT30X60T3G
		50	1.5	SP3F	Yes	APTGT50X60T3G
		75	1.5	SP3F	Yes	APTGT75X60T3G
1200	Trench 3	25	1.7	SP3F	Yes	APTGT25X120T3G
		35	1.7	SP3F	Yes	APTGT35X120T3G
	Trench 4	40	1.85	SP3F	Yes	APTGL40X120T3G

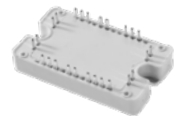

SP3F

Three-Phase Leg

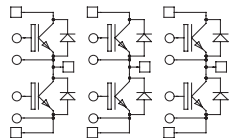

$V_{(BR)CES}$ (V)	IGBT Type	I_c (A) $T_c = 80\text{ }^\circ\text{C}$	$V_{CE(on)}$ (V) at Rated I_c	Package	NTC	Part Number
600	Trench 3	50	1.5	SP6-P	Option	APTGT50TA60PG
		150	1.5	SP6-P	Option	APTGT150TA60PG
650	Trench 5	30	1.65	SP3F	Yes	APTGTQ50TA65T3G
		90	1.65	SP6-P	Yes	APTGTQ150TA65TPG
1200	Trench 3	75	1.7	SP6-P	Option	APTGT75TA120PG
		100	1.7	SP6-P	Yes	APTGT100TA120TPG
	Trench 4	120	1.85	SP6-P	Yes	APTGL120TA120TPG



SP4

Triple Dual Common Source

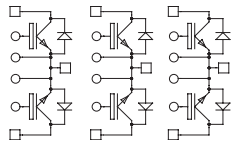

$V_{(BR)CES}$ (V)	IGBT Type	I_c (A) $T_c = 80\text{ }^\circ\text{C}$	$V_{CE(on)}$ (V) at Rated I_c	Package	NTC	Part Number
600	Trench 3	50	1.5	SP6-P	Option	APTGT50TDU60PG
		75	1.5	SP6-P	Option	APTGT75TDU60PG
		100	1.5	SP6-P	Option	APTGT100TDU60PG
		150	1.5	SP6-P	Option	APTGT150TDU60PG
1200	Trench 3	75	1.7	SP6-P	Option	APTGT75TDU120PG
	Trench 4	120	1.85	SP6-P	Yes	APTGL120TDU120TPG
1700	Trench 3	50	2	SP6-P	Option	APTGT50TDU170PG



SP6-P

Dual Chopper

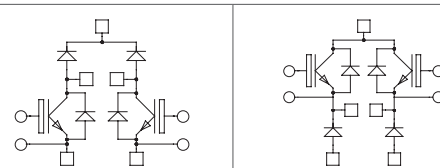

$V_{(BR)CES}$ (V)	IGBT Type	I_c (A) $T_c = 80\text{ }^\circ\text{C}$	$V_{CE(on)}$ (V) at Rated I_c	Package	NTC	...DDA...	...DSK...
600	Trench 3	50	1.5	SP3F	Yes	APTGT50DDA60T3G	
		75	1.5	SP3F	Yes	APTGT75DDA60T3G	
650	Trench 5	60	1.65	SP3F	Yes	APTGTQ100DDA65T3G	
	Trench 4 Fast	50	1.85	SP3F	Yes	APTGLQ50DDA65T3G	
		50	1.85	SP3F	Yes	APTGLQ50VDA65T3G	
1200	Trench 3	50	1.7	SP3F	Yes	APTGT50DDA120T3G	
	Trench 4	60	1.85	SP3F	Yes	APTGL60DDA120T3G	
		90	1.85	SP3F	Yes	APTGL90DDA120T3G	APTGL90DSK120T3G

IGBT Power Modules (continued)

Full and Asymmetrical

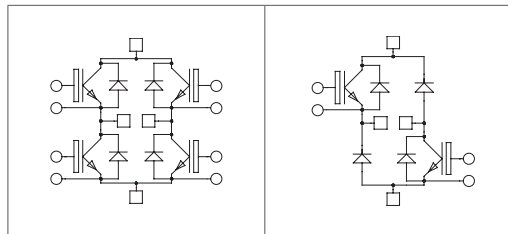

$V_{(BR)CES}$ (V)	IGBT Type	I_C (A) $T_C = 80\text{ }^\circ\text{C}$	$V_{CE(on)}$ (V) at Rated I_C	Package	NTC	...H...	...DH...
600	Trench 3	20	1.5	SP1	Yes	APTGT20H60T1G	
		30	1.5	SP1	Yes	APTGT30H60T1G	
		50	1.5	SP1	Yes	APTGT50H60T1G	APTGT50DH60T1G
		50	1.5	SP3F	Yes	APTGT50H60T3G	
		75	1.5	SP1	Yes	APTGT75H60T1G	
		75	1.5	SP2	Yes	APTGT75H60T2G	
		75	1.5	SP3F	Yes	APTGT75H60T3G	
		100	1.5	SP4	Yes	APTGT100H60TG	APTGT100DH60TG
		100	1.5	SP3F	Yes	APTGT100H60T3G	
		150	1.5	SP4	Yes	APTGT150H60TG	APTGT150DH60TG
		200	1.5	SP6	No	APTGT200H60G	APTGT200DH60G
300	1.5	SP6	No	APTGT300H60G	APTGT300DH60G		
650	Trench 4 Fast	30	1.95	SP3F	Yes	APTGLQ30H65T3G	
		50	1.85	SP1	Yes	APTGLQ50H65T1G	
		50	1.85	SP3F	Yes	APTGLQ50H65T3G	
		75	1.85	SP1	Yes	APTGLQ75H65T1G	
		100	1.85	SP3F	Yes	APTGLQ100H65T3G	
		200	1.85	SP6C	No	APTGLQ200H65G	
		300	1.85	SP6	Option	APTGLQ300H65G	
650	Trench 5	60	1.65	SP3F	Yes	APTGTQ100H65T3G	
1200	Trench 3	35	1.7	SP3F	Yes	APTGT35H120T3G	
		50	1.7	SP3F	Yes	APTGT50H120T3G	
		50	1.7	SP4	Yes		APTGT50DH120TG
		75	1.7	SP3F	Yes		APTGT75DH120T3G
		75	1.7	SP4	Yes	APTGT75H120TG	
		100	1.7	SP4	Yes		APTGT100DH120TG
		100	1.7	SP6	No	APTGT100H120G	
		150	1.7	SP6	No	APTGT150H120G	APTGT150DH120G
	200	1.7	SP6	No	APTGT200H120G	APTGT200DH120G	
	Trench 4	40	1.85	SP1	Yes	APTGL40H120T1G	
		60	1.85	SP3F	Yes	APTGL60H120T3G	
		90	1.85	SP3F	Yes	APTGL90H120T3G	
	Trench 4 Fast	25	2.05	SP1	Yes	APTGLQ25H120T1G	
		25	2.05	SP2	Yes	APTGLQ25H120T2G	
40		2.05	SP1	Yes	APTGLQ40H120T1G		
75		2.05	SP3F	Yes	APTGLQ75H120T3G		
75		2.05	SP4	Yes	APTGLQ75H120TG		
150		2.05	SP6C	No	APTGLQ150H120G		
200		2.05	SP6	Option	APTGLQ200H120G		
1700	Trench 3	30	2	SP3F	Yes	APTGT30H170T3G	
		50	2	SP4	Yes	APTGT50H170TG	APTGT50DH170TG
		100	2	SP6	No	APTGT100H170G	
		150	2	SP6	No	APTGT150H170G	APTGT150DH170G



SP1

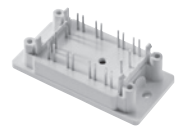

SP2

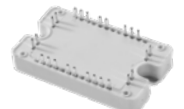

SP3F



SP4



SP6 Full Bridge

IGBT Power Modules (continued)

Single Switch

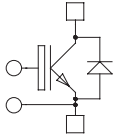

V_{CES} (V)	IGBT Type	I_c (A) $T_c = 80\text{ }^\circ\text{C}$	$V_{CE(on)}$ (V) at Rated I_c	Package	NTC	Part Number
600	Trench 3	750	1.5	D4	No	APTGT750U60D4G
1200	Trench 3	400	1.7	D4	No	APTGT400U120D4G
		600	1.7	D4	No	APTGT600U120D4G
	Trench 4	475	1.85	D4	No	APTGL475U120D4G
		700	1.85	D4	No	APTGL700U120D4G
1700	Trench 3	400	2	D4	No	APTGT400U170D4G
		600	2	D4	No	APTGT600U170D4G



D4

Single Switch + Series Diode

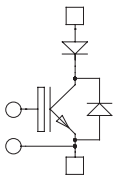

V_{CES} (V)	IGBT Type	I_c (A) $T_c = 80\text{ }^\circ\text{C}$	$V_{CE(on)}$ (V) at Rated I_c	Package	NTC	Part Number
1200	Trench 4	475	1.85	SP6	No	APTGL475U120DAG



SP4

Dual Common Source

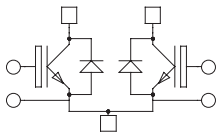

V_{CES} (V)	IGBT Type	I_c (A) $T_c = 80\text{ }^\circ\text{C}$	$V_{CE(on)}$ (V) at Rated I_c	Package	NTC	Part Number
600	Trench 3	100	1.5	SP4	Yes	APTGT100DU60TG
		200	1.5	SP4	Yes	APTGT200DU60TG
		300	1.4	SP6	No	APTGT300DU60G
		600	1.4	SP6	No	APTGT600DU60G
1200	Trench 3	50	1.7	SP4	Yes	APTGT50DU120TG
		75	1.7	SP4	Yes	APTGT75DU120TG
		100	1.7	SP4	Yes	APTGT100DU120TG
		150	1.7	SP6	No	APTGT150DU120G
		150	1.7	SP4	Yes	APTGT150DU120TG
		200	1.7	SP6	No	APTGT200DU120G
		300	1.7	SP6	No	APTGT300DU120G
		400	1.7	SP6	No	APTGT400DU120G
1700	Trench 3	100	2	SP4	Yes	APTGT100DU170TG
		225	2	SP6	No	APTGT225DU170G
		300	2	SP6	No	APTGT300DU170G



SP6

Intelligent Power Modules

Phase Leg

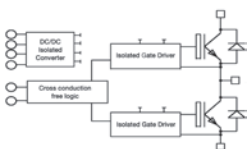

V_{CES} (V)	IGBT Type	I_c (A) $T_c = 80\text{ }^\circ\text{C}$	$V_{CE(on)}$ (V) at Rated I_c	Package	NTC	Part Number
600	Trench 3	400	1.5	LP8	No	APTLGT400A608G
1200	Trench 3	300	1.7	LP8	No	APTLGT300A1208G
	Trench 4	325	1.8	LP8	No	APTLGL325A1208G



LP8

MOSFET Power Modules

Chopper

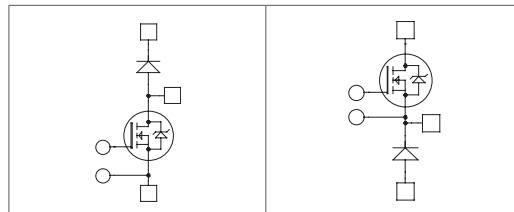

V_{DSS} (V)	MOSFET Type	$R_{DS(on)}$ (mΩ)	I_D (A) $T_c = 80\text{ °C}$	Package	NTC	DA...or...U2	SK...or...U3
100	MOS 5	11	100	SOT-227	No	APT10M11JV RU2	APT10M11JV RU3
		4.5	207	SP4	Yes	APTM10DAM05TG	APTM10SKM05TG
		2.25	370	SP6	No	APTM10DAM02G	APTM10SKM02G
200	MOS 5	22	71	SOT-227	No	APT20M22JV RU2	APT20M22JV RU3
	MOS 7	8	147	SP4	Yes	APTM20DAM08TG	APTM20SKM08TG
		5	250	SP6	Option	APTM20DAM05G	
		4	300	SP6	Option	APTM20DAM04G	APTM20SKM04G
500	MOS 5	100	30	SOT-227	No	APT5010JV RU2	APT5010JV RU3
	MOS 7	100	30	SOT-227	No	APT5010JLLU2	APT5010JLLU3
		75	32	SOT-227	No	APT50M75JLLU2	APT50M75JLLU3
		19	125	SP6	Option	APTM50DAM19G	APTM50SKM19G
		17	140	SP6	Option	APTM50DAM17G	APTM50SKM17G
	MOS 8	65	43	SOT-227	No	APT58M50JU2	APT58M50JU3
600	Super Junction MOSFET	70	40	SOT-227	No	APT40N60JCU2	APT40N60JCU3
24		70	SP1	Yes		APTC60SKM24T1G	
900	Super Junction MOSFET	120	25	SOT-227	No	APT33N90JCU2	APT33N90JCU3
		60	44	SP1	Yes	APTC90DAM60T1G	APTC90SKM60T1G
1000	MOS 7	180	33	SP4	Yes	APTM100DA18TG	
		90	59	SP6	Option	APTM100DAM90G	
	MOS 8	330	17	SP1	Yes	APTM100DA33T1G	APTM100SK33T1G
1200	MOS 8	300	23	SP1	Yes	APTM120DA30T1G	

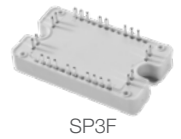

Dual Chopper

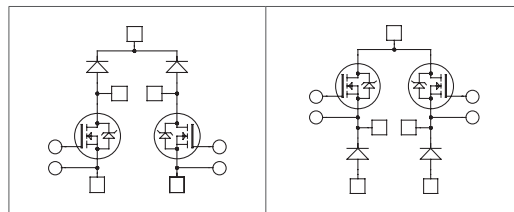

V_{DSS} (V)	MOSFET Type	$R_{DS(on)}$ (mΩ)	I_D (A) $T_c = 80\text{ °C}$	Package	NTC	...DDA...	...DSK...
100	MOS 5	19	50	SP3F	Yes		APTM10DSKM19T3G
		9	100	SP3F	Yes		APTM10DSKM09T3G
500	MOS 7	100	24	SP3F	Yes	APTM50DDA10T3G	
		65	37	SP3F	Yes	APTM50DDAM65T3G	
600	Super Junction MOSFET	45	38	SP1	Yes	APTC60DDAM45T1G	
		70	29	SP1	Yes	APTC60DDAM70T1G	
		35	54	SP3F	Yes	APTC60DDAM35T3G	
		24	70	SP3F	Yes	APTC60DDAM24T3G	APTC60DSKM24T3G
800	Super Junction MOSFET	150	21	SP3F	Yes	APTC80DDA15T3G	
1000		MOS 7	350	17	SP3F	Yes	APTM100DSK35T3G



MOSFET Power Modules (continued)

Full Bridge

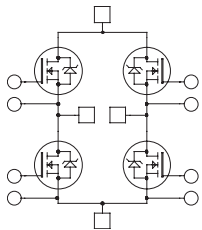

V_{DSS} (V)	MOSFET Type	$R_{DS(on)}$ (m Ω)	I_D (A) $T_c = 80^\circ\text{C}$	Package	NTC	Part Number	
100	FREDFET 5	4.5	207	SP6	No	APTM10HM05FG	
		19	50	SP3F	Yes	APTM10HM19FT3G	
		9	100	SP3F	Yes	APTM10HM09FT3G	
200	FREDFET 7	20	62	SP4	Yes	APTM20HM20FTG	
		16	74	SP4	Yes	APTM20HM16FTG	
		10	125	SP6	No	APTM20HM10FTG	
		8	147	SP6	No	APTM20HM08FTG	
		140	18	SP3F	Yes	APTM50H14FT3G	
500	FREDFET 7	100	24	SP3F	Yes	APTM50H10FT3G	
		75	32	SP4	Yes	APTM50HM75FTG	
		75	32	SP3F	Yes	APTM50HM75FT3G	
		65	37	SP4	Yes	APTM50HM65FTG	
		65	37	SP3F	Yes	APTM50HM65FT3G	
		38	64	SP6	No	APTM50HM38FG	
		35	70	SP6	No	APTM50HM35FG	
		150	19	SP1	Yes	APTM50H15FT1G	
	600	Super Junction MOSFET	70	29	SP1	Yes	APTC60HM70T1G
			45	38	SP1	Yes	APTC60HM45T1G
83			21	SP2	Yes	APTC60HM83FT2G	
70			29	SP3F	Yes	APTC60HM70T3G	
35			54	SP3F	Yes	APTC60HM35T3G	
24			70	SP3F	Yes	APTC60HM24T3G	
600	FREDFET 8	230	15	SP1	Yes	APTM60H23FT1G	
		70	29	SP1	Yes	APTC60HM70T1G	
800	Super Junction MOSFET	150	21	SP1	Yes	APTC80H15T1G	
		290	11	SP3F	Yes	APTC80H29T3G	
		150	21	SP3F	Yes	APTC80H15T3G	
900	Super Junction MOSFET	120	23	SP1	Yes	APTC90H12T1G	
		60	44	SP3F	Yes	APTC90HM60T3G	
		450	14	SP3F	Yes	APTM100H45FT3G	
1000	FREDFET 7	350	17	SP4	Yes	APTM100H35FTG	
		350	17	SP3F	Yes	APTM100H35FT3G	
		180	33	SP6	No	APTM100H18FTG	
		460	14	SP3F	Yes	APTM100H46FT3G	
1200	FREDFET 7	290	25	SP6	No	APTM120H29FTG	
		1400	6	SP1	Yes	APTM120H140FT1G	



SP1



SP3F



SP4

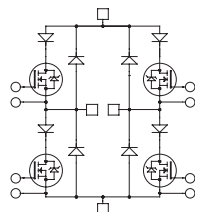

Full Bridge + Series and Parallel

V_{DSS} (V)	MOSFET Type	$R_{DS(on)}$ (m Ω)	I_D (A) $T_c = 80^\circ\text{C}$	Package	NTC	Part Number
200	MOS 7	20	62	SP4	Yes	APTM20HM20STG
500	MOS 7	75	32	SP4	Yes	APTM50HM75STG
1000	MOS 7	450	13	SP4	Yes	APTM100H45STG



SP6

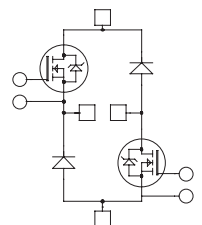

Asymmetrical Bridge

V_{DSS} (V)	MOSFET Type	$R_{DS(on)}$ (m Ω)	I_D (A) $T_c = 80^\circ\text{C}$	Package	NTC	Part Number
100	MOS5	4.5	207	SP6	No	APTM10DHM05G
500	MOS 7	38	64	SP6	No	APTM50DHM38G
600	Super Junction MOSFET	24	70	SP3F	Yes	APTC60DHM24T3G

MOSFET Power Modules (continued)

Phase Leg

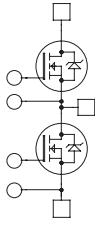

V _{DSS} (V)	MOSFET Type	R _{DS(on)} (mΩ)	I _D (A) T _C = 80 °C	Package	NTC	Part Number
100	FREDFET 5	4.5	207	SP4	Yes	APTM10AM05FTG
		2.25	370	SP6	Option	APTM10AM02FG
200	FREDFET 7	10	125	SP4	Yes	APTM20AM10FTG
		8	147	SP4	Yes	APTM20AM08FTG
		5	250	SP6	Option	APTM20AM05FG
		4	300	SP6	Option	APTM20AM04FG
500	FREDFET 7	38	64	SP4	Yes	APTM50AM38FTG
		35	70	SP4	Yes	APTM50AM35FTG
		19	125	SP6	Option	APTM50AM19FG
		17	140	SP6	Option	APTM50AM17FG
600	Super Junction MOSFET	45	38	SP1	Yes	APTC60AM45T1G
		35	54	SP1	Yes	APTC60AM35T1G
		24	70	SP1	Yes	APTC60AM24T1G
		24	70	SP2	No	APTC60AM242G
	FREDFET 8	110	30	SP1	Yes	APTM60A11FT1G
900	Super Junction MOSFET	60	44	SP1	Yes	APTC90AM60T1G
1000	FREDFET 7	180	33	SP4	Yes	APTM100A18FTG
		90	59	SP6	Option	APTM100AM90FG
1200	FREDFET 7	290	25	SP4	Yes	APTM120A29FTG
		150	45	SP6	Option	APTM120A15FG



SP1

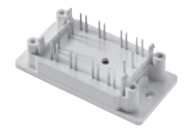

SP2

Phase Leg + Series and Parallel

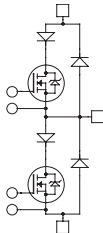

V _{DSS} (V)	MOSFET Type	R _{DS(on)} (mΩ)	I _D (A) T _C = 80 °C	Package	NTC	Part Number
200	MOS 7	10	125	SP4	Yes	APTM20AM10STG
		6	225	SP6	No	APTM20AM06SG
500	MOS 7	38	64	SP4	Yes	APTM50AM38STG
		24	110	SP6	No	APTM50AM24SG
1000	MOS 7	230	26	SP4	Yes	APTM100A23STG
		130	49	SP6	No	APTM100A13SG
1200	MOS 7	200	37	SP6	No	APTM120A20SG



SP4

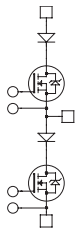

Phase Leg + Series Diodes

V _{DSS} (V)	MOSFET Type	R _{DS(on)} (mΩ)	I _D (A) T _C = 80 °C	Package	NTC	Part Number
1000	MOS 7	130	49	SP6	No	APTM100A13DG
1200	MOS 7	200	37	SP6	No	APTM120A20DG



SP6

Triple Phase Leg

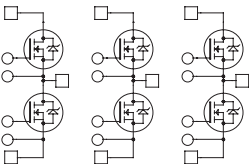

V _{DSS} (V)	MOSFET Type	R _{DS(on)} (mΩ)	I _D (A) T _C = 80 °C	Package	NTC	Part Number
75	MOSFET	4.2	90	SP6-P	Option	APTM08TAM04PG
100	FREDFET 5	19	50	SP6-P	Option	APTM10TAM19FPG
		9	100	SP6-P	Option	APTM10TAM09FPG
200	FREDFET 7	16	74	SP6-P	Option	APTM20TAM16FPG
500	FREDFET 7	65	37	SP6-P	Option	APTM50TAM65FPG
600	Super Junction MOSFET	35	54	SP6-P	Option	APTC60TAM35PG
		24	70	SP6-P	Yes	APTC60TAM24TPG
800		150	21	SP6-P	Option	APTC80TA15PG
900		60	44	SP6-P	Yes	APTC90TAM60TPG
1000	FREDFET 7	350	17	SP6-P	Option	APTM100TA35FPG



SP6-P

MOSFET Power Modules (continued)

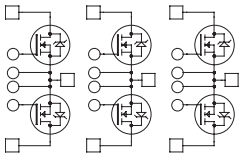

Triple Dual Common Source

V_{DS} (V)	MOSFET Type	$R_{DS(on)}$ (mΩ)	I_D (A) $T_c = 80\text{ °C}$	Package	NTC	Part Number
600	Super Junction	35	54	SP6-P	Option	APTC60TDUM35PG
800	MOSFET	150	21	SP6-P	Option	APTC80TDU15PG



SP1

Dual Common Source

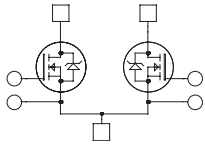

V_{DS} (V)	MOSFET Type	$R_{DS(on)}$ (mΩ)	I_D (A) $T_c = 80\text{ °C}$	Package	NTC	Part Number
100	MOS 5	2.25	370	SP6	No	APTM10DUM02G
200	MOS 7	8	147	SP4	Yes	APTM20DUM08TG
		5	250	SP6	No	APTM20DUM05G
		4	300	SP6	No	APTM20DUM04G
1200	MOS 7	150	45	SP6	No	APTM120DU15G

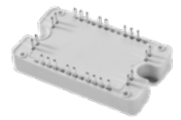

SP3F

Single Switch

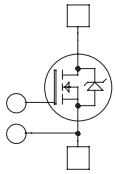

V_{DS} (V)	MOSFET Type	$R_{DS(on)}$ (mΩ)	I_D (A) $T_c = 80\text{ °C}$	Package	NTC	Part Number
100	FREDFET 5	2.25	430	SP6	Option	APTM10UM02FAG
		1.5	640	SP6	Option	APTM10UM01FAG
200	FREDFET 7	3	434	SP6	Option	APTM20UM03FAG
500	FREDFET 7	9	371	SP6	Option	APTM50UM09FAG
1000	FREDFET 7	60	97	SP6	Option	APTM100UM60FAG
		45	160	SP6	Option	APTM100UM45FAG
1200	FREDFET 7	70	126	SP6	Option	APTM120UM70FAG



SP4

Single Switch + Series Diode

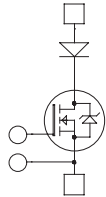

V_{DS} (V)	MOSFET Type	$R_{DS(on)}$ (mΩ)	I_D (A) $T_c = 80\text{ °C}$	Package	NTC	Part Number
1000	MOS 7	65	110	SP6	No	APTM100UM65DAG
		45	160	SP6	No	APTM100UM45DAG
1200	MOS 7	70	126	SP6	No	APTM120UM70DAG



SP6

Single Switch + Series and Parallel

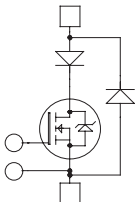

V_{DS} (V)	MOSFET Type	$R_{DS(on)}$ (mΩ)	I_D (A) $T_c = 80\text{ °C}$	Package	NTC	Part Number
200	MOS 7	4	310	SP6	Option	APTM20UM04SAG
500	MOS 7	13	250	SP6	Option	APTM50UM13SAG
1000	MOS 7	65	110	SP6	Option	APTM100UM65SAG
1200	MOS 7	100	86	SP6	Option	APTM120U10SAG



SP6-P

Interleaved PFC

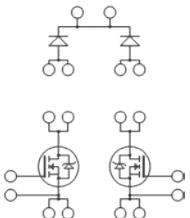

V_{DS} (V)	MOSFET Type	$R_{DS(on)}$ (mΩ)	I_D (A) $T_c = 80\text{ °C}$	Package	NTC	Part Number
600	Super Junction	45	38	SP1	Yes	APTC60VDAM45T1G
	MOSFET	24	70	SP3F	Yes	APTC60VDAM24T3G

MOSFET Power Modules (continued)

Single and Dual Linear MOSFET

V_{DS} (V)	MOSFET Type	$R_{DS(on)}$ (m Ω)	Shunt Resistor (mR)	Package	NTC		
600	MOS4 Linear	125	20	SP3F	Yes		APTML602U12R020T3AG
1000	MOS4 Linear	600	20	SP1	Yes	APTML100U60R020T1AG	

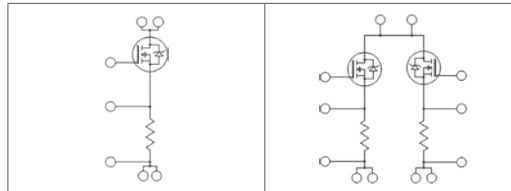

SP3F



SP1

Renewable Energy Power Modules

Full Bridge

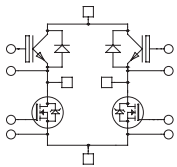

V_{CES} (V)	Technology	I_c (A) $T_c = 80^\circ\text{C}$	$V_{CE(on)}$ (V) at Rated I_c	Package	NTC	Part Number
600	Mix Trench IGBT & Super Junction MOSFET	50	83MR/1.5	SP1	Yes	APTVC40H60CT1G
		50	45MR/1.5	SP3F	Yes	APTVC50H60T3G



SP1

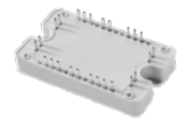

SP3F

PFC + Bypass Diode + Phase Leg

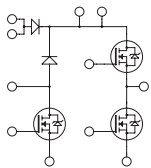

V_{CES} (V)	Technology	I_c (A) $T_c = 80^\circ\text{C}$	$V_{CE(on)}$ (V) at Rated I_c	Package	NTC	Special	Part Number
600	Super Junction MOSFET	38	45MR	SP1	N/A	10 A PFC SiC Diode	APTVC60AM45BC1G
		38	45MR	SP1	N/A		APTVC60AM45B1G
		27	83MR	SP1	N/A	10 A PFC SiC Diode	

PFC + Bypass Diode + Full Bridge

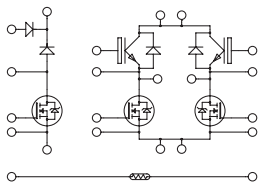

V_{CES} (V)	Technology	I_c (A) $T_c = 80^\circ\text{C}$	$V_{CE(on)}$ (V) at Rated I_c	Package	NTC	Special	Part Number
600	Mix Trench IGBT & Super Junction MOSFET	38	1.5/45MR	SP3F	Yes	20 A PFC SiC Diode	APTVC60HM45BC20T3G
		38	1.5/45MR	SP3F	Yes		APTVC60HM45BT3G
	Super Junction MOSFET	29	70MR	SP3F	Yes		APTVC60HM70BT3G

Secondary Fast Rectifier + Full Bridge

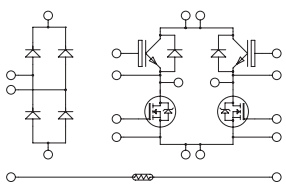

V_{CES} (V)	Technology	I_c (A) $T_c = 80^\circ\text{C}$	$V_{CE(on)}$ (V) at Rated I_c	Package	NTC	Special	Part Number
600	Mix Trench IGBT & Super Junction MOSFET	38	1.5/45MR	SP3F	Yes	20 A SiC Antiparallel Diode	APTVC60HM45RCT3G
		38	1.5/45MR	SP3F	Yes		APTVC60HM45RT3G
	Super Junction MOSFET	29	70MR	SP3F	Yes		APTVC60HM70RT3G
	Trench 3	50	1.5	SP3F	Yes		APTGT50H60RT3G

Renewable Energy Power Modules (continued)

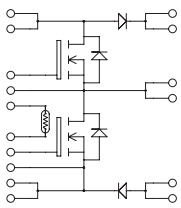

Boost Buck

V_{CES} (V)	Technology	I_c (A) $T_c = 80\text{ }^\circ\text{C}$	$V_{CE(on)}$ (V) at Rated I_c	Package	NTC	Part Number
600	Super Junction MOSFET	70	24MR	SP3F	Yes	APTC60BBM24T3G
	Trench 3	100	1.5	SP3F	Yes	APTGT100BB60T3G



SP1

Three-Level NPC Inverter

V_{CES} (V)	Technology	I_c (A) $T_c = 80\text{ }^\circ\text{C}$	$V_{CE(on)}$ (V) at Rated I_c	Package	NTC	Part Number
600	Trench 3	20	1.5	SP1	No	APTGT20TL601G
		30	1.5	SP1	No	APTGT30TL601G
		50	1.5	SP3F	Yes	APTGT50TL60T3G
		50	1.5	SP1	No	APTGT50TL601G
		75	1.5	SP3F	Yes	APTGT75TL60T3G
		100	1.5	SP3F	Yes	APTGT100TL60T3G
		150	1.5	SP6	No	APTGT150TL60G
		200	1.5	SP6	No	APTGT200TL60G
650	Trench 3	300	1.5	SP6	No	APTGT300TL65G
		400	1.5	SP6	No	APTGT400TL65G
1200	Trench 4	60	1.85	SP3F	Yes	APTGL60TL120T3G
		240	1.8	SP6	No	APTGL240TL120G
1700	Trench 3	100	2	SP6	No	APTGT100TL170G
V_{CES} (V)	Technology	$R_{DS(on)}$ Super Junction MOSFET (m Ω)	$V_{CE(on)}$ IGBT (V) / I_c (A)	Package	NTC	Part Number
600	Mix Trench IGBT and Super Junction MOSFET	24	1.5/75	SP3F	Yes	APTCV60TLM24T3G
		45	1.5/75	SP3F	Yes	APTCV60TLM45T3G
		70	1.5/50	SP3F	Yes	APTCV60TLM70T3G
		99	1.5/30	SP3F	Yes	APTCV60TLM99T3G
		120	1.85/50	SP3F	Yes	APTCV90TL12T3G

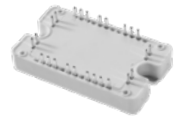
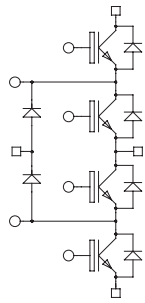

SP3F

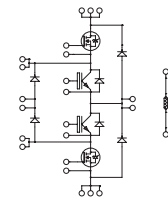

SP6 3-Level

T-Type 3-Level Inverter

V_{CES} (V)	Technology	I_c (A) $T_c = 80\text{ }^\circ\text{C}$	$V_{CE(on)}$ (V) at Rated I_c	Package	NTC	Special	Part Number
600/1200	Trench 4 Fast	40	2.05	SP3F	Yes	10A/600 V SiC	APTGLQ40HR120CT3G
		80	2.05	SP3F	Yes	30A/600 V SiC	APTGLQ80HR120CT3G
		200	2.05	SP6	No		APTGLQ200HR120G

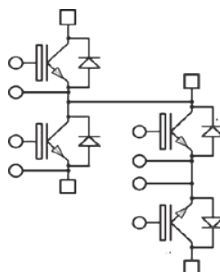

Power Modules with SiC Schottky Diodes

SiC Schottky diodes offer superior dynamic and thermal performance over conventional silicon power diodes. The main advantages of the SiC Schottky diodes are:

- Essentially zero forward and reverse recovery—reduced switch and diode switching losses
- Temperature independent switching behavior—stable high temperature performance
- Positive temperature coefficient of V_F —ease of parallel operation

- Usable 175 °C junction temperature—safely operate at higher temperatures

Extremely fast switching of SiC Schottky diode enables designs with:

- Improved system efficiency
- Higher reliability
- Lower system switching losses
- Lower system cost
 - Smaller EMI filter
 - Smaller magnetic components
 - Smaller heat-sink
 - Smaller switches, eliminates snubbers

- Reduced system size
 - Fewer/smaller components

Applications:

- PFC
- Output rectification
- Solar inverter
- Motor control
- Snubber diode

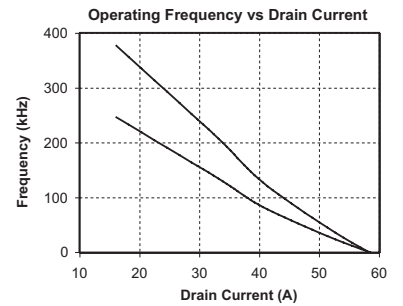

Diode Power Modules with SiC Diodes

Dual Diode



V_{RRM} (V)	Diode Type	I_F (A) $T_C = 100\text{ }^\circ\text{C}$	V_F (V) $T_J = 25\text{ }^\circ\text{C}$	Package	Anti-Parallel	Parallel
600	SiC	20	1.6	SOT-227	APT2X20DC60J	APT2X21DC60J
		30	1.6	SOT-227	APT2X30DC60J	APT2X31DC60J
		40	1.6	SOT-227	APT2X41DC60J	APT2X41DC60J
		50	1.6	SOT-227	APT2X50DC60J	APT2X51DC60J
		60	1.6	SOT-227	APT2X60DC60J	APT2X61DC60J
1200	SiC	20	1.6	SOT-227	APT2X20DC120J	APT2X21DC120J
		40	1.6	SOT-227	APT2X40DC120J	APT2X41DC120J
		50	1.6	SOT-227	APT2X50DC120J	APT2X51DC120J
		60	1.6	SOT-227	APT2X60DC120J	APT2X61DC120J



Full Bridge

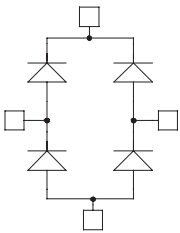

V_{RRM} (V)	Diode Type	I_F (A) $T_C = 100\text{ }^\circ\text{C}$	V_F (V) $T_J = 25\text{ }^\circ\text{C}$	Package	Part Number
600	SiC	40	1.6	SP1	APTDC40H601G
		40	1.6	SOT-227	APT40DC60HJ
1200	SiC	10	1.6	SOT-227	APT10DC120HJ
		20	1.6	SP1	APTDC20H1201G
		20	1.6	SOT-227	APT20DC120HJ
		40	1.6	SP1	APTDC40H1201G
		40	1.6	SOT-227	APT40DC120HJ



IGBT Power Modules with SiC Diodes

Boost Chopper

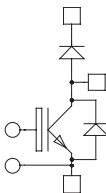

V_{RRM} (V)	IGBT Type	I_D (A) $T_C = 80\text{ }^\circ\text{C}$	$V_{CE(on)}$ (V) at Rated I_C	Package	NTC	Part Number
1200	Trench 4 Fast	25	2.05	SOT-227	No	APT25GLQ120JCU2
		40	2.05	SOT-227	No	APT40GLQ120JCU2

Dual Chopper

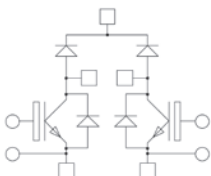

V_{RRM} (V)	IGBT Type	I_D (A) $T_C = 80\text{ }^\circ\text{C}$	$V_{CE(on)}$ (V) at Rated I_C	Package	NTC	Part Number
1200	Trench 4 Fast	40	2.05	SP3F	Yes	APTGLQ40DDA120CT3G



Power Modules with SiC Schottky Diodes (continued)

MOSFETs and Super Junction MOSFET Power Modules with SiC Diodes

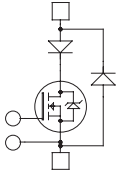

Single Switch + Series FRED and SiC Parallel Diodes

V_{DSS} (V)	MOSFET Type	$R_{DS(on)}$ (mΩ)	I_D (A) $T_c = 80\text{ }^\circ\text{C}$	Package	NTC	Part Number
1000	MOS 7	65	110	SP6	Option	APTM100UM65SCAVG
1200	MOS 7	100	86	SP6	Option	APTM120U10SCAVG



SOT-227

Chopper

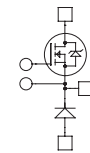
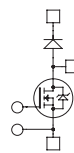

V_{DSS} (V)	MOSFET Type	$R_{DS(on)}$ (mΩ)	I_D (A) $T_c = 80\text{ }^\circ\text{C}$	Package	NTC	...DA... or U2	...SK... or U3
500	MOS 8	65	43	SOT-227	No	APT58M50JCU2	
600	Super Junction MOSFET	45	38	SOT-227	No	APT50N60JCCU2	
		24	70	SP1	Yes		APTC60SKM24CT1G
900	Super Junction MOSFET	18	107	SP4	Yes	APTC60DAM18CTG	
		120	25	SOT-227	No	APT33N90JCCU2	
1000	MOS 8	60	44	SP1	Yes	APTC90DAM60CT1G	APTC90SKM60CT1G
		330	20	SOT-227	No	APT26M100JCU2	APT26M100JCU3
1200	MOS 8	560	15	SOT-227	No	APT20M120JCU2	APT20M120JCU3
		300	23	SP1	Yes	APTM120DA30CT1G	



SP1

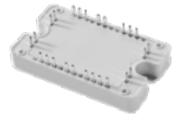

SP3F

Phase Leg + Series FRED and SiC Parallel Diodes

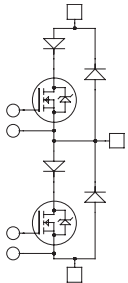

V_{DSS} (V)	MOSFET Type	$R_{DS(on)}$ (mΩ)	I_D (A) $T_c = 80\text{ }^\circ\text{C}$	Package	NTC	Part Number
500	MOS 7	38	67	SP4	Yes	APTM50AM38SCTG
		24	110	SP6	No	APTM50AM24SCG
600	Super Junction MOSFET	35	54	SP4	Yes	APTC60AM35SCTG
		24	70	SP4	Yes	APTC60AM24SCTG
		18	107	SP6	No	APTC60AM18SCG
900	Super Junction MOSFET	60	44	SP4	Yes	APTC90AM60SCTG
		150	21	SP4	Yes	APTC80A15SCTG
		100	32	SP4	Yes	APTC80A10SCTG
1000	MOS 7	75	43	SP6	No	APTC80AM75SCG
		130	49	SP6	No	APTM100A13SCG



SP4

Full Bridge + Series FRED and SiC Parallel Diodes

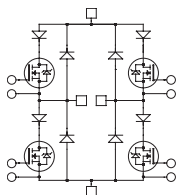

V_{DSS} (V)	MOSFET Type	$R_{DS(on)}$ (mΩ)	I_D (A) $T_c = 80\text{ }^\circ\text{C}$	Package	NTC	Part Number
500	MOS 7	75	34	SP4	Yes	APTM50HM75SCTG
		70	29	SP4	Yes	APTC60HM70SCTG
600	Super Junction MOSFET	45	38	SP4	Yes	APTC60HM45SCTG
		290	11	SP4	Yes	APTC80H29SCTG
900		120	23	SP4	Yes	APTC90H12SCTG
1000	MOS 7	450	14	SP4	Yes	APTM100H45SCTG



SP6

Triple Phase Leg

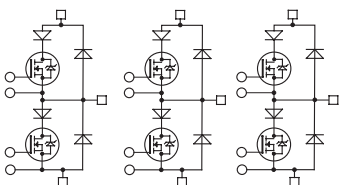

V_{DSS} (V)	MOSFET Type	$R_{DS(on)}$ (mΩ)	I_D (A) $T_c = 80\text{ }^\circ\text{C}$	Package	NTC	Part Number
600	Super Junction MOSFET	24	87	SP6-P	Yes	APTC60TAM21SCTPAG
1000	MOS 7	350	50	SP6-P	Yes	APTM100TA35SCTPG



SP6-P

SiC MOSFET Power Modules

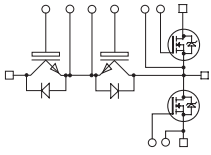

T-Type Three-Level Inverter

V_{CES} (V)	Technology	$R_{DS(on)}$ (m Ω)	I_D (A) $T_c = 80^\circ\text{C}$	Package	NTC	Part Number
600/1200	IGBT and SiC MOSFET	110	20	SP3F	Yes	APTMC120HR11CT3AG
		40	50	SP3F	Yes	APTMC120HRM40CT3AG

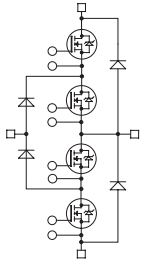

Three-Level NPC Inverter

V_{CES} (V)	Technology	$R_{DS(on)}$ (m Ω)	I_D (A) $T_c = 80^\circ\text{C}$	Package	NTC	Part Number
600	SiC MOSFET	110	20	SP3F	Yes	APTMC60TL11CT3AG
		55	40	SP3F	Yes	APTMC60TLM55CT3AG
		14	160	SP6	No	APTMC60TLM14CAG

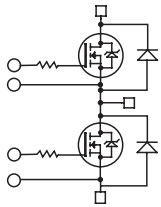

Phase Leg

V_{CES} (V)	Technology	$R_{DS(on)}$ (m Ω)	I_D (A) $T_c = 80^\circ\text{C}$	Package	NTC	Part Number
1200	SiC MOSFET	55	40	SP1	Yes	APTMC120AM55CT1AG
		25	80	SP3F	Yes	APTMC120AM25CT3AG
		20	108	SP1	Yes	APTMC120AM20CT1AG
		16	102	D3	No	APTMC120AM16CD3AG
		12	150	SP3F	Yes	APTMC120AM12CT3AG
		9	200	SP3F	Yes	APTMC120AM09CT3AG
		8	200	D3	No	APTMC120AM08CD3AG
1700	SiC MOSFET	60	40	SP1	Yes	APTMC170AM60CT1AG
		30	80	SP1	Yes	APTMC170AM30CT1AG

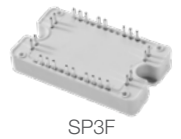

Phase Leg: Very Low Inductance Package

V_{CES} (V)	Technology	$R_{DS(on)}$ (m Ω)	I_D (A) $T_c = 80^\circ\text{C}$	Package	NTC	Part Number
1200	SiC MOSFET	6.7	210	SP6LI	Yes	MSCMC120AM07CT6LIAG <i>New!</i>
		4.2	307	SP6LI	Yes	MSCMC120AM04CT6LIAG <i>New!</i>
		2.5	475	SP6LI	Yes	MSCMC120AM03CT6LIAG <i>New!</i>
		2.1	586	SP6LI	Yes	MSCMC120AM02CT6LIAG <i>New!</i>
1700	SiC MOSFET	7.5	207	SP6LI	Yes	MSCMC170AM08CT6LIAG <i>New!</i>

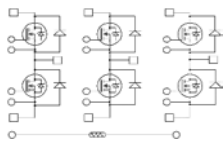

Triple Phase Leg

V_{CES} (V)	Technology	$R_{DS(on)}$ (m Ω)	I_D (A) $T_c = 80^\circ\text{C}$	Package	NTC	Part Number
1200	SiC MOSFET	34	55	SP3F	Yes	APTMC120TAM34CT3AG
		33	60	SP6-P	Yes	APTMC120TAM33CTPAG
		17	100	SP6-P	Yes	APTMC120TAM17CTPAG
		12	150	SP6-P	Yes	APTMC120TAM12CTPAG



Boost Chopper

V_{CES} (V)	Technology	$R_{DS(on)}$ (m Ω)	I_D (A) $T_c = 80^\circ\text{C}$	Package	NTC	Part Number
1200	SiC MOSFET	34	50	SOT-227	No	APT50MC120JCU2
		17	100	SOT-227	No	APT100MC120JCU2

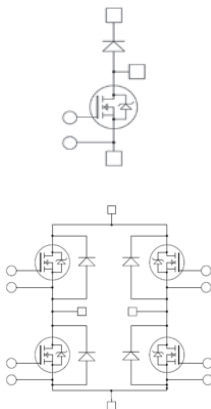

Full Bridge

V_{CES} (V)	Technology	$R_{DS(on)}$ (m Ω)	I_D (A) $T_c = 80^\circ\text{C}$	Package	NTC	Part Number
1200	SiC MOSFET	17	110	SP3F	Yes	APTMC120HM17CT3AG



Diode Power Modules

Single Diode

V_{RRM} (V)	Diode Type	I_F (A) $T_C = 80^\circ\text{C}$	V_F (V) $T_C = 80^\circ\text{C}$	Package	Part Number
200	FRED	500	1.1	LP4	APTDF500U20G
400		500	1.5		APTDF500U40G
600		450	1.8		APTDF450U60G
1000		430	2.3		APTDF430U100G
1200		400	2.5		APTDF400U120G

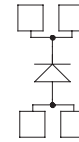

SOT-227



LP4

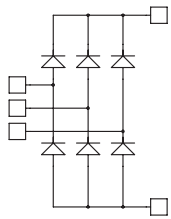

Single Diode

V_{RRM} (V)	Diode Type	I_F (A) $T_C = 80^\circ\text{C}$	V_F (V) $T_J = 25^\circ\text{C}$	Package	Part Number
1600	Rectifier	40	1.3	SP1	APTDR40X1601G
		90	1.3	SP1	APTDR90X1601G



LP4

Full Bridge

V_{RRM} (V)	Diode Type	I_F (A) $T_C = 80^\circ\text{C}$	V_F (A) $T_C = 80^\circ\text{C}$	Package	Part Number
200	FRED	30	1	SOT-227	APT30DF20HJ
		60	1	SOT-227	APT60DF20HJ
		100	1	SP4	APTDF100H20G
600		30	1.8	SP1	APTDF30H601G
		30	1.8	SOT-227	APT30DF60HJ
		60	1.8	SOT-227	APT60DF60HJ
		60	1.8	SP1	APTDF60H601G
		100	1.6	SOT-227	APT100DL60HJ
		100	1.6	SP1	APTDF100H601G
1000		200	1.6	SP6	APTDF200H60G
		30	2.1	SOT-227	APT30DF100HJ
		100	2.1	SP4	APTDF100H100G
1200	200	2.1	SP6	APTDF200H100G	
	30	2.6	SP1	APTDF30H1201G	
	60	2.6	SP1	APTDF60H1201G	
1700	75	1.6	SOT-227	APT75DL120HJ	
	200	2.4	SP6	APTDF200H120G	
	50	1.8	SOT-227	APT50DF170HJ	
1600	75	1.8	SOT-227	APT75DF170HJ	
	100	2.2	SP4	APTDF100H170G	
	200	2.2	SP6	APTDF200H170G	
1600	RECTIFIER	40	1.3	SOT-227	APT40DR160HJ
		90	1.3	SOT-227	APT90DR160HJ

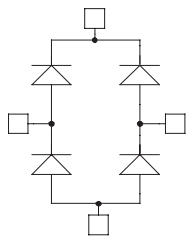

SP4



SP6

Common Cathode–Common Anode–Doubler

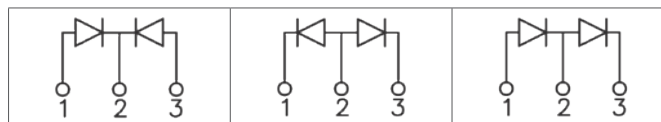

V_{RRM} (V)	Diode Type	I_F (A) per Diode	V_F (V) $T_J = 25^\circ\text{C}$	Package	Common Cathode	Common Anode	Doubler
200	FRED	400	1	SP6	APTDF400KK20G	APTDF400AA20G	APTDF400AK20G
600			1.6		APTDF400KK60G	APTDF400AA60G	APTDF400AK60G
1000			2.1		APTDF400KK100G	APTDF400AA100G	APTDF400AK100G
1200			2.4		APTDF400KK120G	APTDF400AA120G	APTDF400AK120G
1700			2.2		APTDF400KK170G	APTDF400AA170G	APTDF400AK170G

Package Outlines

Pinout location depends on the module configuration. Please refer to the product datasheet for pin assignments. All dimensions in millimeters.

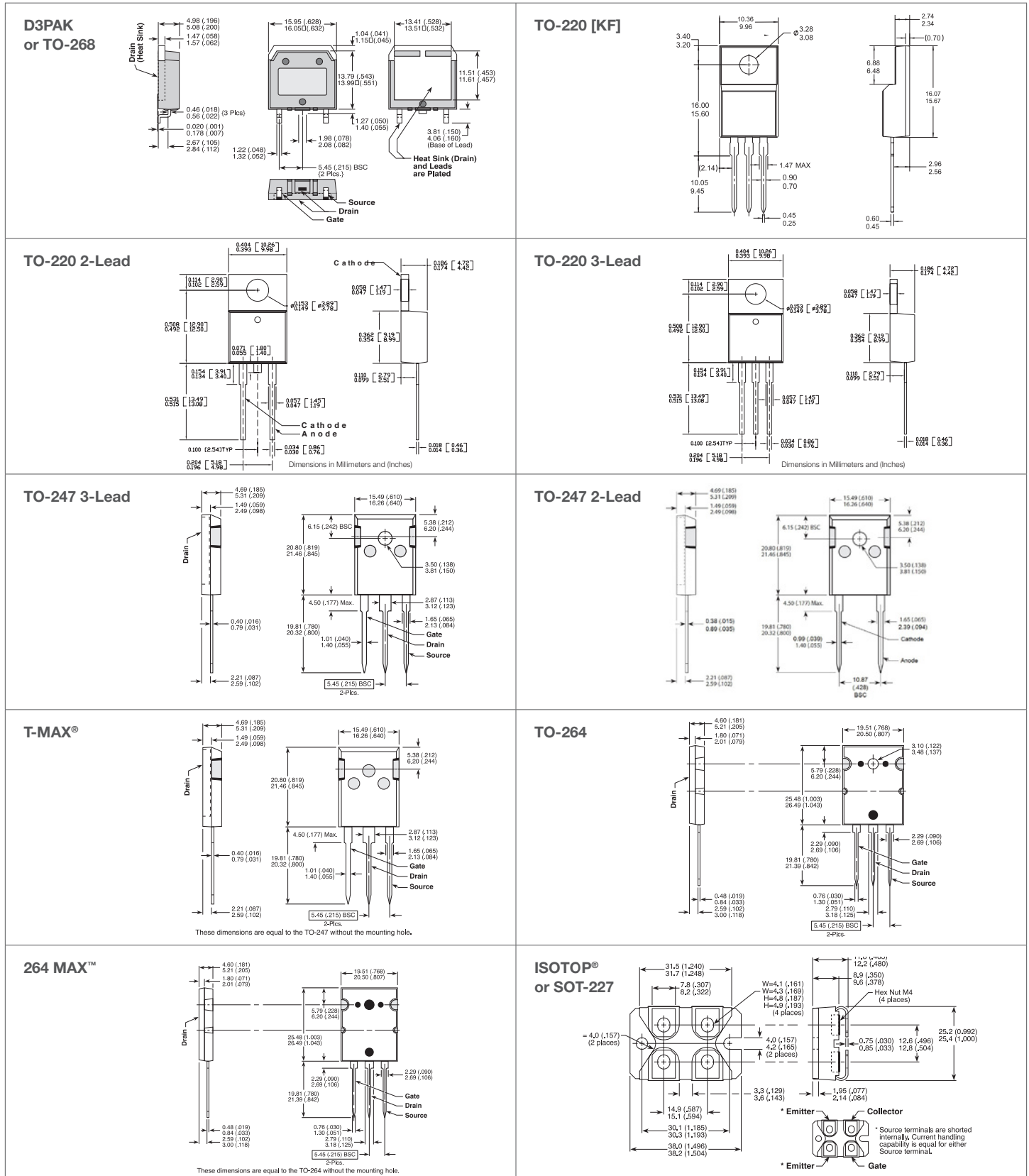

Refer to web page for additional package outline drawings

ISOTOP® is a registered trademark of SGS Thomson

Power Module Outlines

Pinout location depends on the module configuration. Please refer to the product datasheet for pin assignments. All dimensions in millimeters.

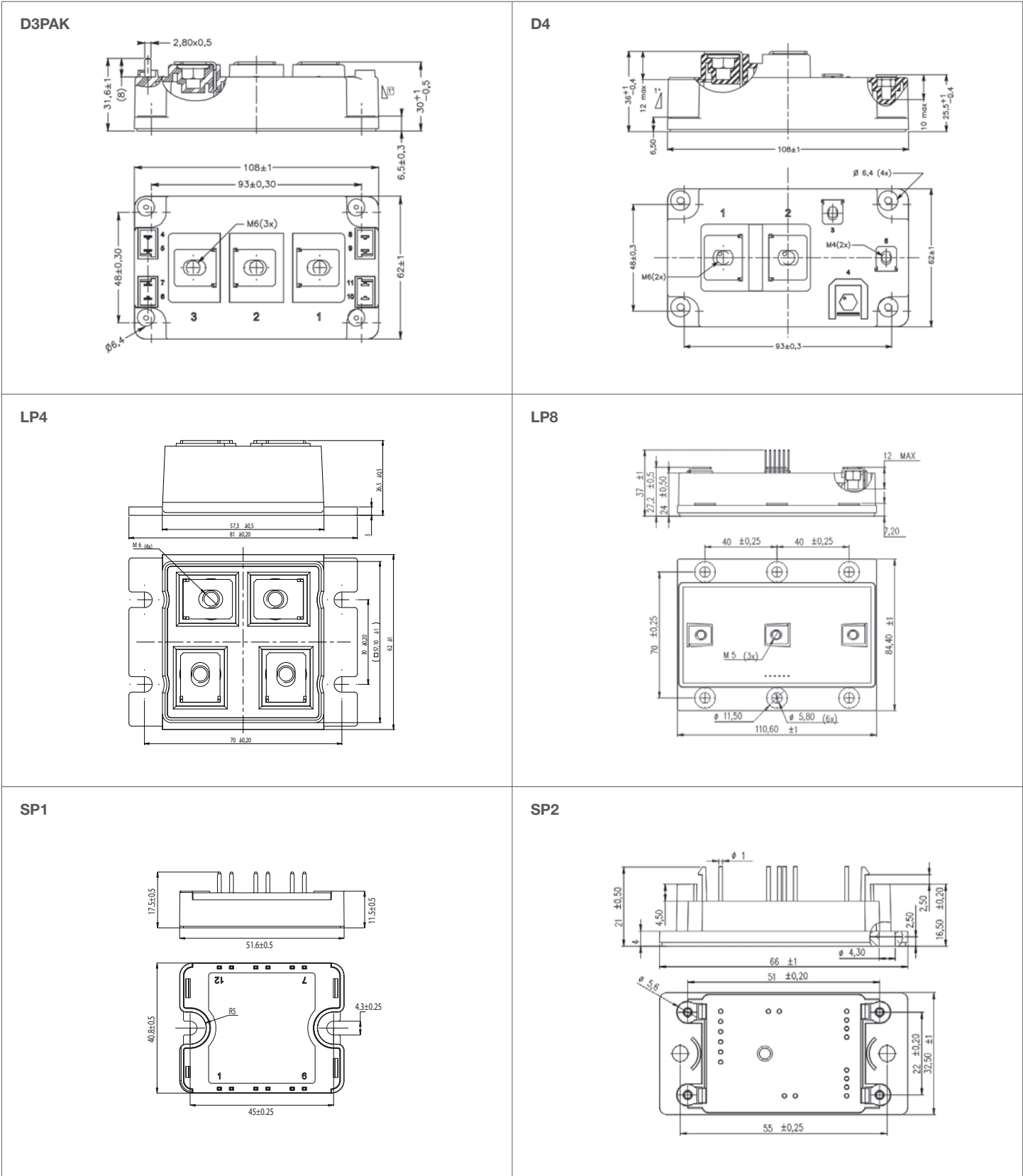

Power Module Outlines (continued)

Pinout location depends on the module configuration. Please refer to the product datasheet for pin assignments. All dimensions are in millimeters.

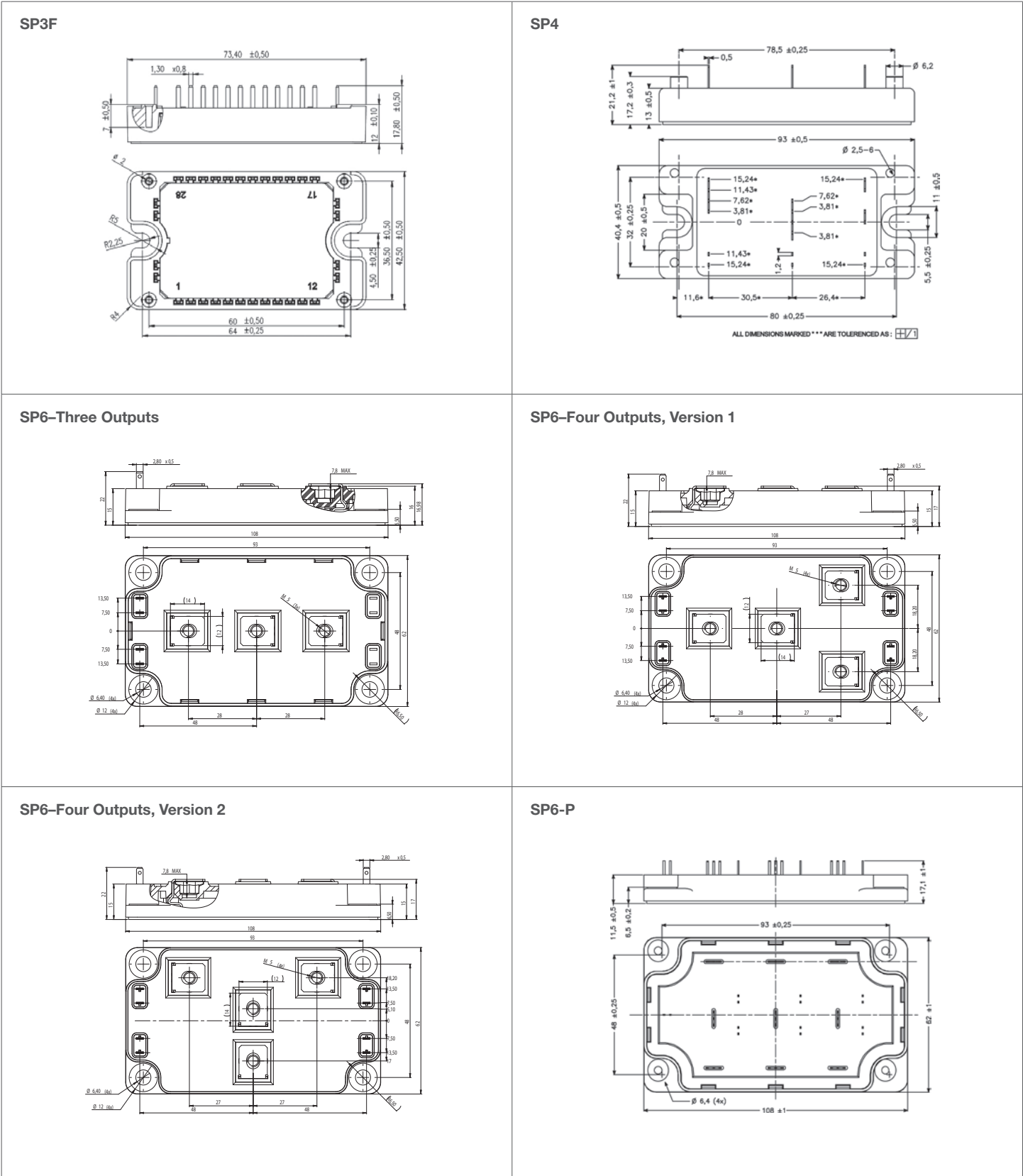

Power Module Outlines (continued)

Pinout location depends on the module configuration. Please refer to the product datasheet for pin assignments. All dimensions are in millimeters.

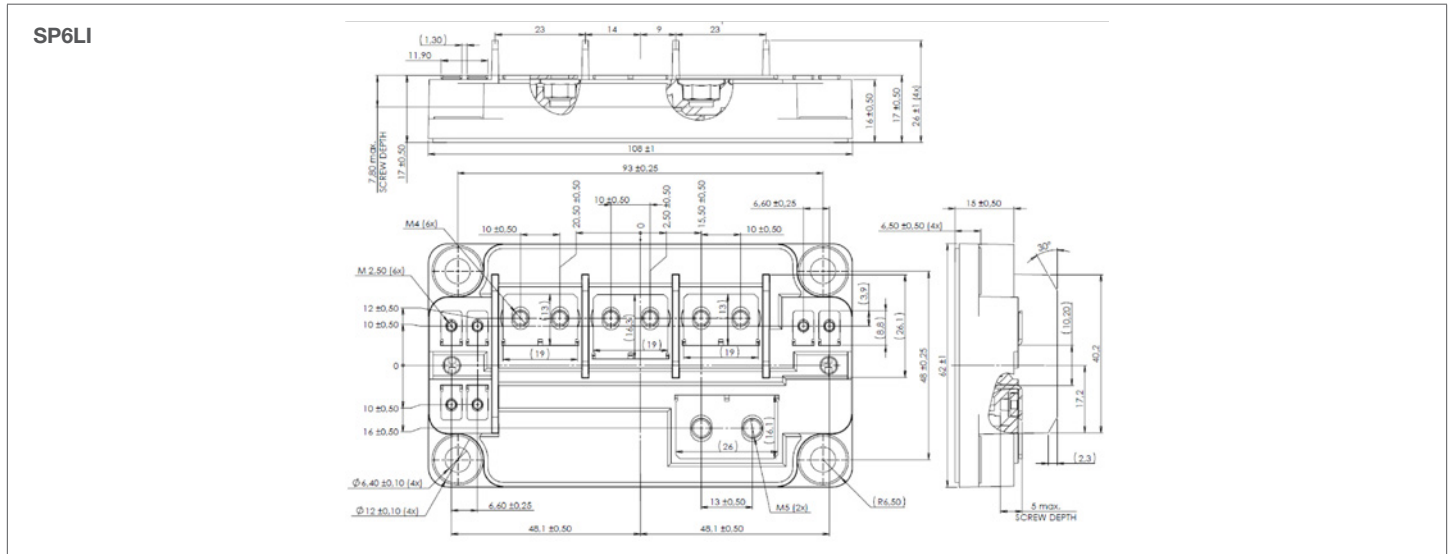

Microsemi is continually adding new products to its industry-leading portfolio.

For the most recent updates to our product line and for detailed information and specifications, please call, email, or visit our website.

Toll-free: 800-713-4113

sales.support@microsemi.com

www.microsemi.com



Microsemi Corporate Headquarters
One Enterprise, Aliso Viejo, CA 92656 USA
Within the USA: +1 (800) 713-4113
Outside the USA: +1 (949) 380-6100
Fax: +1 (949) 215-4996
Email: sales.support@microsemi.com
www.microsemi.com

Microsemi Corporation (Nasdaq: MSCC) offers a comprehensive portfolio of semiconductor and system solutions for aerospace & defense, communications, data center and industrial markets. Products include high-performance and radiation-hardened analog mixed-signal integrated circuits, FPGAs, SoCs and ASICs; power management products; timing and synchronization devices and precise time solutions, setting the world's standard for time; voice processing devices; RF solutions; discrete components; enterprise storage and communication solutions, security technologies and scalable anti-tamper products; Ethernet solutions; Power-over-Ethernet ICs and midspans; as well as custom design capabilities and services. Microsemi is headquartered in Aliso Viejo, California and has approximately 4,800 employees globally. Learn more at www.microsemi.com.

Microsemi makes no warranty, representation, or guarantee regarding the information contained herein or the suitability of its products and services for any particular purpose, nor does Microsemi assume any liability whatsoever arising out of the application or use of any product or circuit. The products sold hereunder and any other products sold by Microsemi have been subject to limited testing and should not be used in conjunction with mission-critical equipment or applications. Any performance specifications are believed to be reliable but are not verified, and Buyer must conduct and complete all performance and other testing of the products, alone and together with, or installed in, any end-products. Buyer shall not rely on any data and performance specifications or parameters provided by Microsemi. It is the Buyer's responsibility to independently determine suitability of any products and to test and verify the same. The information provided by Microsemi hereunder is provided "as is, where is" and with all faults, and the entire risk associated with such information is entirely with the Buyer. Microsemi does not grant, explicitly or implicitly, to any party any patent rights, licenses, or any other IP rights, whether with regard to such information itself or anything described by such information. Information provided in this document is proprietary to Microsemi, and Microsemi reserves the right to make any changes to the information in this document or to any products and services at any time without notice.

MSCC-0344-BR-01000-1.0-0518

X-ON Electronics

Largest Supplier of Electrical and Electronic Components

Click to view similar products for [MOSFET](#) category:

Click to view products by [Microsemi](#) manufacturer:

Other Similar products are found below :

[614233C](#) [648584F](#) [IRFD120](#) [JANTX2N5237](#) [FCA20N60_F109](#) [FDZ595PZ](#) [2SK2545\(Q,T\)](#) [405094E](#) [423220D](#) [TPCC8103,L1Q\(CM](#)
[MIC4420CM-TR](#) [VN1206L](#) [614234A](#) [715780A](#) [NTNS3166NZT5G](#) [SSM6J414TU,LF\(T](#) [751625C](#) [BUK954R8-60E](#) [NTE6400](#) [SQJ402EP-](#)
[T1-GE3](#) [2SK2614\(TE16L1,Q\)](#) [2N7002KW-FAI](#) [DMN1017UCP3-7](#) [EFC2J004NUZTDG](#) [ECH8691-TL-W](#) [FCAB21350L1](#) [P85W28HP2F-](#)
[7071](#) [DMN1053UCP4-7](#) [NTE221](#) [NTE222](#) [NTE2384](#) [NTE2903](#) [NTE2941](#) [NTE2945](#) [NTE2946](#) [NTE2960](#) [NTE2967](#) [NTE2969](#) [NTE2976](#)
[NTE6400A](#) [NTE2910](#) [NTE2916](#) [NTE2956](#) [NTE2911](#) [DMN2080UCB4-7](#) [TK10A80W,S4X\(S](#) [SSM6P69NU,LF](#) [DMP22D4UFO-7B](#)
[DMN1006UCA6-7](#) [DMN16M9UCA6-7](#)