

800mA Very High PSRR Low-Dropout Linear Regulator

Description

LX8240 is a low-dropout regulator offering the highest Power Supply Rejection Ratio (PSRR), higher than 48 dB over all frequency up to 100kHz, and higher than 32 dB over all frequency up to 1MHz for LDO devices supplying 800mA of output current. LX8240 also requires very low quiescent current. It has separate Bias and Input supply rails to improve efficiency and minimize power dissipation. The V_{BIAS} input includes a voltage compliance range from 2.7V to 5.5V, and the V_{IN} supply range is 1.2V to 4.2V. The output voltage is programmed by an external resistor divider utilizing the 0.5V reference feedback (FB) pin allowing output voltages as low as 1V.

LX8240 is an ideal selection for battery-powered systems where the low quiescent current cannot be compromised. It is also guaranteed to be the stable even with only a 1 μ F ceramic capacitor.

To protect the device the LX8240 also includes internal thermal shutdown, and overcurrent limit features.

Features

- High PSRR, higher than 48 dB over all frequency up to 100kHz
- High PSRR, higher than 32 dB over all frequency up to 1MHz
- +/-2% Accuracy over Temp, Supply and Load
- Adjustable Output (0.5V reference)
- Over Current Limit
- Thermal Protection

Applications

- Low Power Mobile Devices
- Portable Devices
- Post Processing for a Switching Regulator

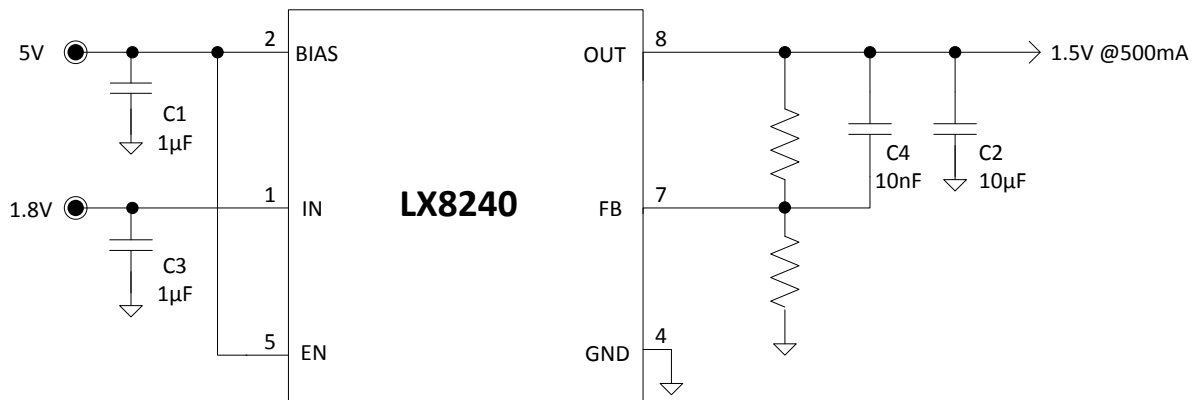

Figure 1 · Typical Application of LX8240

Pin Configuration and Pinout

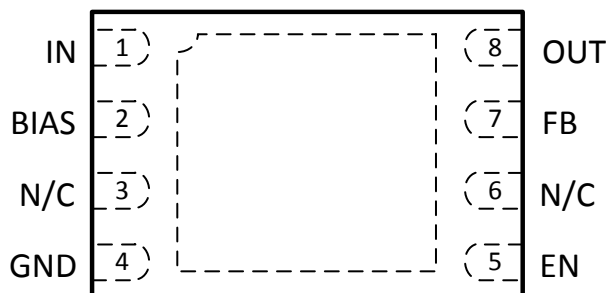

Figure 2 · Pinout WDFN 3mm x 2mm 8L Top View

Marking: Line 1 8240

Line 2 Date / Lot Code

Line 3 * MSC (*Pin 1 identifier)

Ordering Information

Ambient Temperature	Type	Package	Part Number	Packaging Type
-40°C to 85°C	RoHS Compliant, Pb-free	WDFN 3mm x 2mm 8L	LX8240ILD	Bulk / Tube
			LX8240ILD-TR	Tape and Reel

Pin Description

Pin Number	Pin Designator	Description
1	IN	Power Source Input. Bypass IN to GND with a 1 μ F or greater capacitor.
2	BIAS	Bias Voltage. Bypass to GND with a 1 μ F capacitor or greater.
3, 6	NC	No Connect.
4	GND	Ground.
5	EN	Enable Input. Drive EN high to turn on, drive EN low to turn it off. For automatic startup, connect EN to Bias.
7	FB	Feedback Input. Connect a resistive voltage divider from OUT to FB to set the output voltage. OUT feedback threshold is 0.5V.
8	OUT	Regulator Output. OUT is the output of the linear regulator. Bypass OUT to GND with a 1 μ F or greater capacitor.

Block Diagram

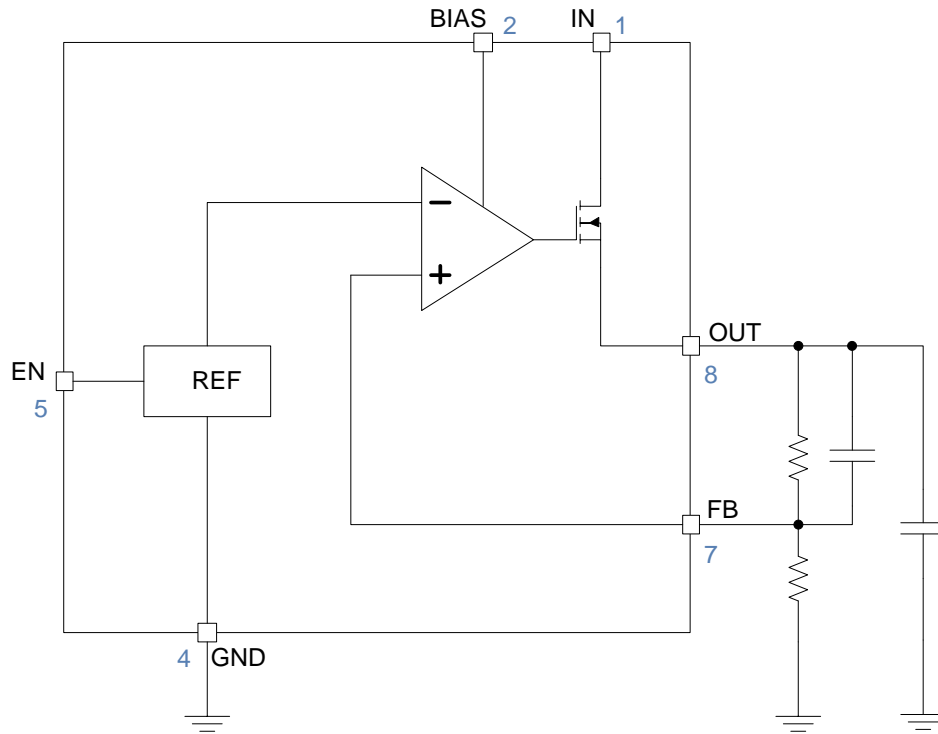

Figure 3 · Simplified Block Diagram of LX8240

Absolute Maximum Ratings

Parameter	Min	Max	Units
IN to GND	-0.3	7	V
BIAS to GND	-0.3	< V _{EN}	
EN, FB to GND	-0.3	7	V
OUT to GND	-0.3	7	V
Junction Temperature	-40	150	°C
Storage Temperature	-65	150	°C
Peak Solder Reflow Temperature (40 seconds)		260 (+0,-5)	°C
ESD Rating	HBM	5000	V
	CDM	2000	V

Note: Performance is not necessarily guaranteed over this entire range. These are maximum stress ratings only. Exceeding these ratings, even momentarily, can cause immediate damage, or negatively impact long-term operating reliability

Operating Ratings

	Min	Max	Units
IN	1.2	4.2	V
BIAS	2.7	5.5	V
Output Voltage	1	4	V
Output Current	0	800	mA
Ambient Temperature	-40	85	°C

Note: Performance is generally guaranteed over this range as further detailed below under Electrical Characteristics.

Thermal Properties

Thermal Resistance	Typ	Units
θ_{JA}	55	°C/W
θ_{JC}	12	°C/W

Note: The θ_{JX} numbers assume no forced airflow. Junction Temperature is calculated using $T_J = T_A + (PD \times \theta_{JA})$. In particular, θ_{JA} is a function of the PCB construction. The stated number above is for a four-layer board in accordance with JESD-51 (JEDEC).

Electrical Characteristics

Note: The following specifications apply over the operating ambient temperature of $-40^\circ\text{C} \leq T_A \leq 85^\circ\text{C}$ except where otherwise noted with the following test conditions: $V_{IN} = 1.8\text{V}$, $V_{BIAS} = 5.0\text{V}$, $V_{OUT} = 1.5\text{V}$, $C1 = C3 = 1\mu\text{F}$ and $C2 = 10\mu\text{F}$ at $T_A = 25^\circ\text{C}$.

Symbol	Parameters	Test Conditions/Comments	Min	Typ	Max	Units
V_{BIAS}	Bias Voltage Range	$V_{BIAS} > V_{IN} + 1.3\text{V}$	2.7		5.5	V
V_{IN}	Input Voltage Range	$V_{IN} < V_{BIAS} - 1.3\text{V}$, $V_{IN} < V_{OUT} + 0.9\text{V}$ @ $I_{OUT} = 800\text{mA}$	1.2		4.2	V
		$V_{IN} < V_{BIAS} - 1.3\text{V}$, $V_{IN} < V_{OUT} + (0.727 / I_{OUT})\text{V}$ @ $V_{OUT} = 1.5\text{V}$, (Note 3)	1.2		4.2	V
I_{BIAS}	Bias Current	$I_{OUT} = 10\mu\text{A}$, $V_{OUT} = 1.5\text{V}$			200	μA
I_{IN}	Input Current	$I_{OUT} = 0\mu\text{A}$, $V_{OUT} = 1.5\text{V}$			20	μA
I_{FB}	FB Biasing Current	$V_{FB} = 0.5\text{V}$, $T_A = 25^\circ\text{C}$	-0.5		0.5	μA
		$V_{FB} = 0.5\text{V}$, $T_A = 85^\circ\text{C}$ (Note 1)		0		μA
V_{REF}	FB Reference Voltage	$I_{OUT} = 1\text{mA}$ to 800mA	0.49	0.5	0.51	V
		$-40^\circ\text{C} \leq T_A \leq 85^\circ\text{C}$	0.49	0.5	0.51	
V_{DO}	Dropout Voltage	$V_{BIAS} = 4.75\text{V}$, $V_{OUT} = 1.5\text{V}$, $I_{OUT} = 800\text{mA}$, $V_{IN} = \text{sweep}$, (Note 2)			200	mV
V_{OUT}	Output Voltage		1		4	V

Symbol	Parameters	Test Conditions/Comments	Min	Typ	Max	Units
	V _{BIAS} Line Regulation	I _{OUT} = 100mA, V _{IN} = 1.8V, V _{OUT} = 1.5V, V _{BIAS} = 3.1V to 5.5V $\frac{V_{OUT}(V_{BIAS} = 5.5V) - V_{OUT}(V_{BIAS} = 3.1V)}{V_{OUT}(V_{BIAS} = 5V) \times (5.5V - 3.1V)} \times 100\%$		0.07	0.4	%/V
	V _{IN} Line Regulation	I _{OUT} = 1mA, V _{BIAS} = 5V, V _{OUT} = 1.5V, V _{IN} = 1.7V to 4.2V $\frac{V_{OUT}(V_{IN} = 4.2V) - V_{OUT}(V_{IN} = 1.7V)}{V_{OUT}(V_{IN} = 1.8V) \times (4.2V - 1.7V)} \times 100\%$		0.002	0.02	%/V
	Load Regulation	I _{OUT} = 1mA to 800mA		0.0005		%/mA
PSRR	V _{BIAS} PSRR	V _{IN} > V _{OUT} + 0.2V, C ₂ = 10μF, V _{BIAS} (AC) = 100mV, f = 1kHz, I _{LOAD} = 100mA, (Note 1)		55		dB
		V _{IN} > V _{OUT} + 0.2V, C ₂ = 10μF, V _{BIAS} (AC) = 100mV, f = 1MHz, I _{LOAD} = 100mA (Note 1)		33		
PSRR	V _{IN} PSRR	V _{BIAS} > V _{OUT} + 1.3V, C ₂ = 10μF, V _{IN} (AC) = 100mV, f = 1kHz, I _{LOAD} = 100mA, (Note 1)		59		dB
		V _{BIAS} > V _{OUT} + 1.3V, C ₂ = 10μF, V _{IN} (AC) = 100mV, f = 1MHz, I _{LOAD} = 100mA (Note 1)		33		
I _{CL}	Output Current Limit		850			mA
I _q	Quiescent Ground Current	EN = GND		0.1	2	μA
		1.3V < EN ≤ V _{BIAS} , I _{LOAD} = 500mA		150	200	μA
	V _{OUT} Undershoot Over Step Load Transient	Load step from 20mA to 450mA with rising time of 100ns (Note 1)		33		mV
	V _{OUT} Overshoot Over Step Load Transient	Load step from 450mA to 20mA with falling time of 600ns (Note 1)		23		mV
	EN Input High Voltage		1.3			V
	EN Input Low Voltage				0.4	V
	EN Input Bias Current	V _{EN} = 1.2V	-1		1	μA
T _{THERMAL}	Thermal Protection Threshold	Rising (Note 1)		155		°C
		Falling (Note 1)		125		°C

Note: 1. Guaranteed by Design

Note: 2. Dropout is defined as V_{IN} - V_{OUT_LDO} when V_{OUT_LDO} is 98% of the value of V_{OUT_LDO} for V_{IN} = V_{OUT} (V_{IN} = 1.8V, V_{BIAS} = 5V, I_{OUT} = 800mA)

Note: 3. 0.727 is the maximum allowed power before thermal shutdown.

Typical Performance Curves -- ($V_{OUT} = 1.5V$)

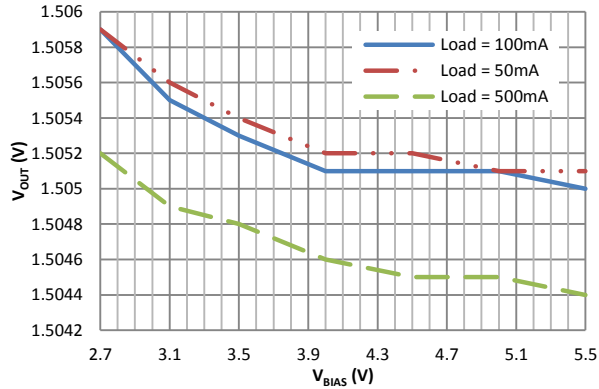

Figure 4 · V_{BIAS} Line Regulation, $V_{IN} = 1.8V$

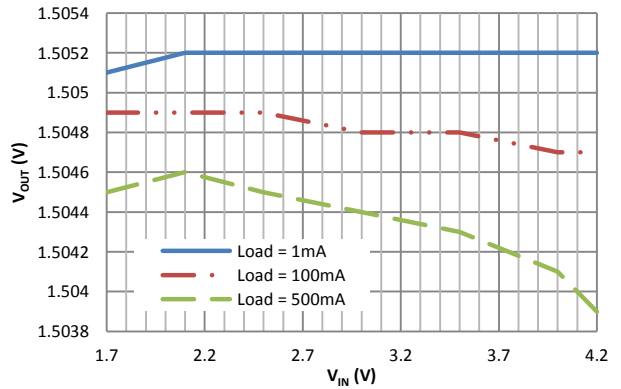

Figure 5 · V_{IN} Line Regulation, $V_{BIAS} = 5V$

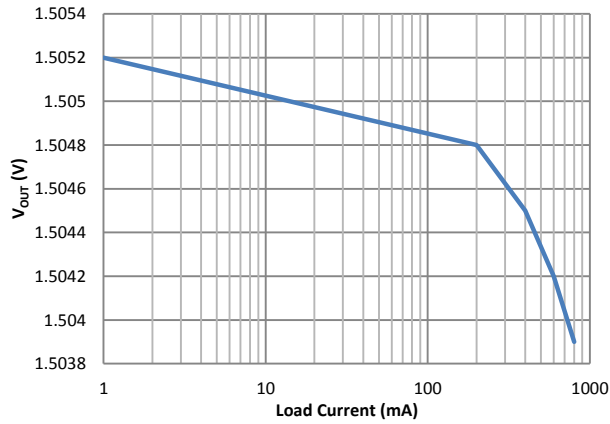

Figure 6 · Load Regulation, $V_{IN} = 1.8V$, $V_{BIAS} = 5V$

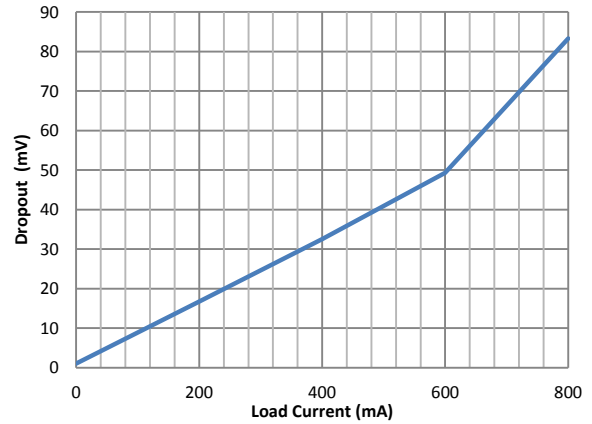

Figure 7 · Voltage Dropout, $V_{IN} = 1.8V$, $V_{BIAS} = 4.75V$

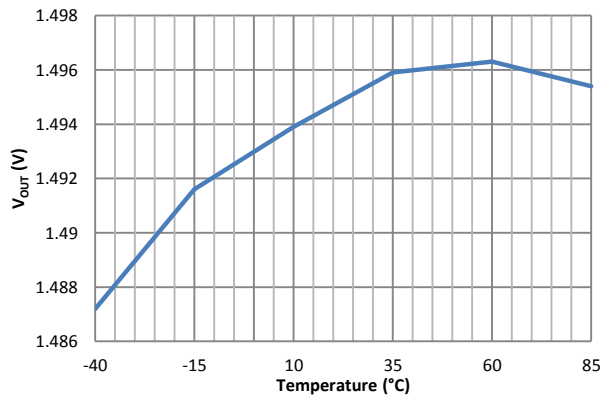

Figure 8 · Output Voltage vs. Temperature

$V_{IN} = 1.8V$, $V_{BIAS} = 4.75V$, $I_{Load} = 300mA$

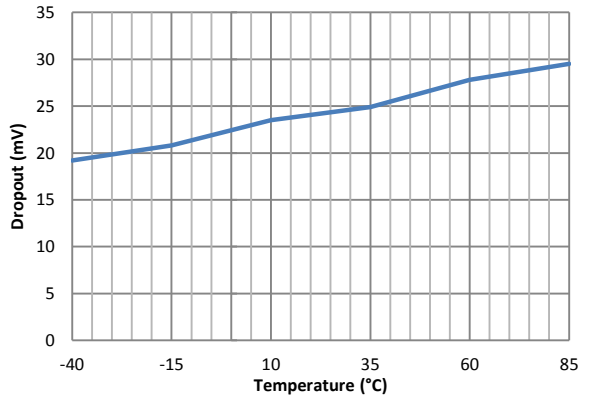

Figure 9 · Voltage Dropout vs. Temperature

$V_{IN} = 1.8V$, $V_{BIAS} = 4.75V$, $I_{Load} = 300mA$

Typical Performance Curves -- ($V_{OUT} = 1.5V$)

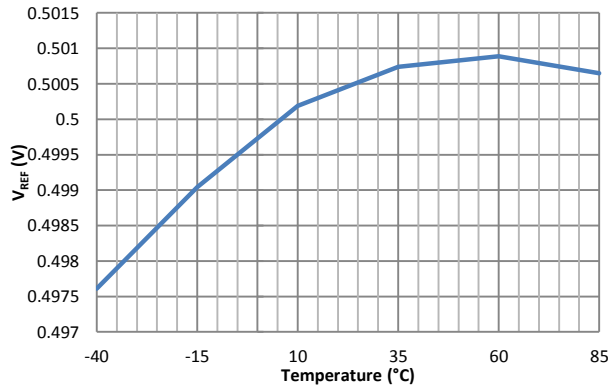

Figure 10 · Reference Voltage vs. Temperature

$V_{IN} = 1.8V$, $V_{BIAS} = 4.75V$, $I_{Load} = 300mA$

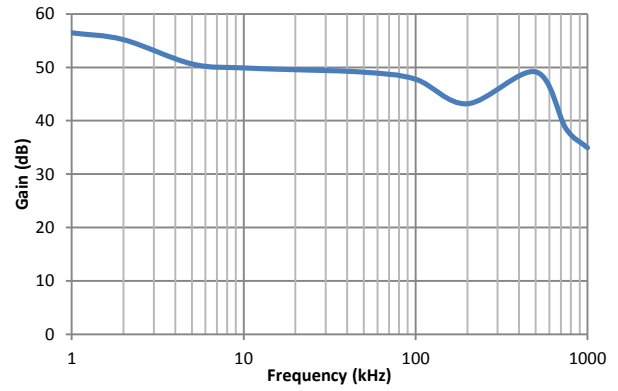

Figure 11 · V_{BIAS} to V_{OUT} PSRR

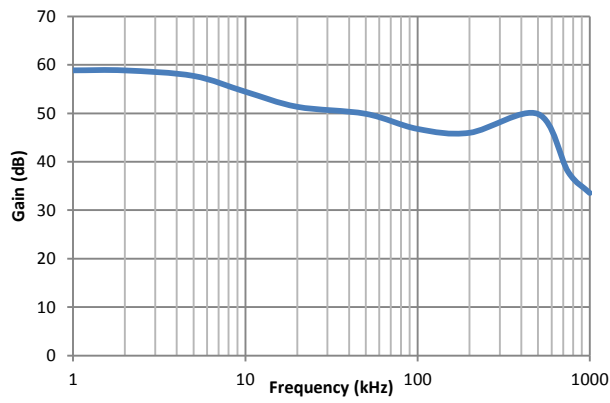

Figure 12 · V_{IN} to V_{OUT} PSRR

Typical Performance Curves -- (Start Up & Shut Down, $V_{OUT} = 1.5V$)

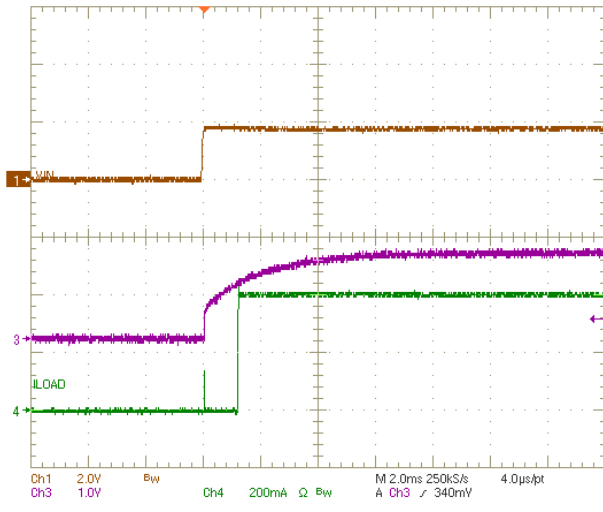

Figure 13 · Power Up with 400mA Load Current

$V_{IN} = 1.8V$, $V_{BIAS} = 5V$

CH1: V_{IN} , CH3: V_{OUT} , CH4: Load Current

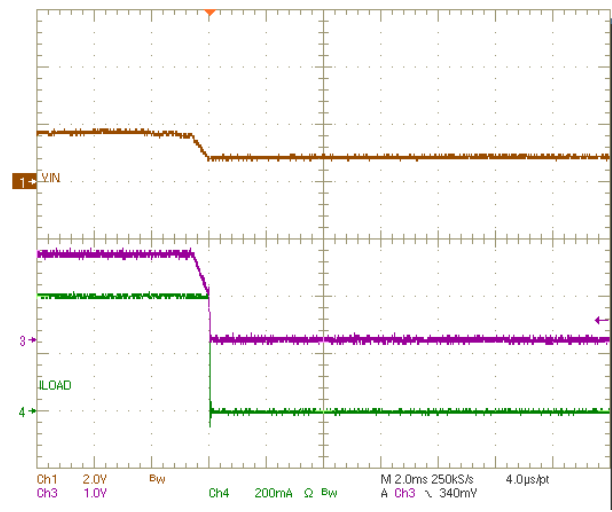

Figure 14 · Power Down with 400mA Load Current

$V_{IN} = 1.8V$, $V_{BIAS} = 5V$

CH1: V_{IN} , CH3: V_{OUT} , CH4: Load Current

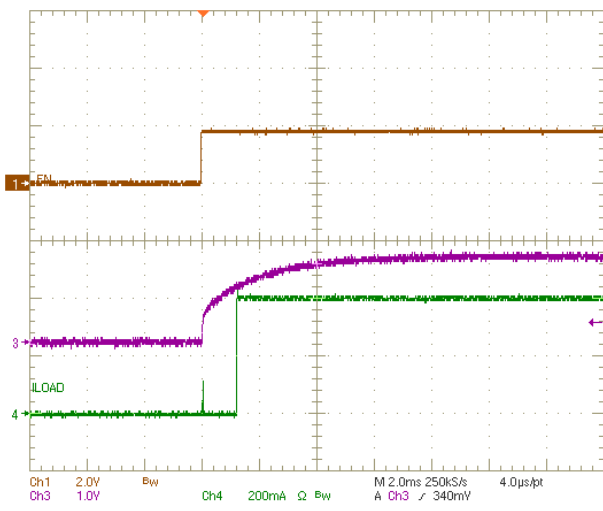

Figure 15 · Enable Up with 400mA Load Current

$V_{IN} = 1.8V$, $V_{BIAS} = 5V$

CH1: V_{IN} , CH3: V_{OUT} , CH4: Load Current

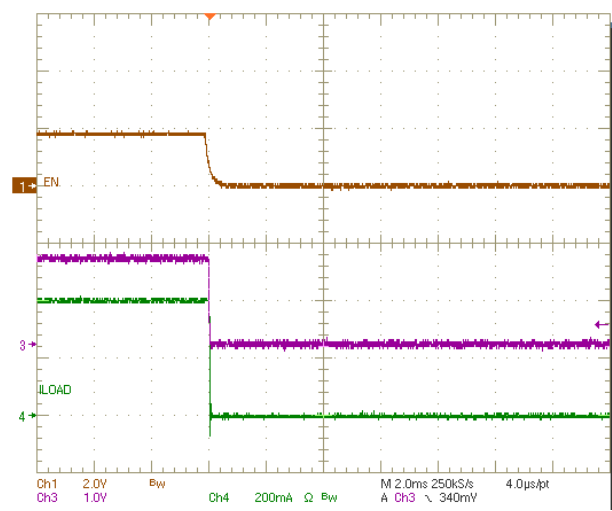

Figure 16 · Enable Down with 400mA Load Current

$V_{IN} = 1.8V$, $V_{BIAS} = 5V$

CH1: V_{IN} , CH3: V_{OUT} , CH4: Load Current

Typical Performance Curves -- (Step Response & Over Current Limit)

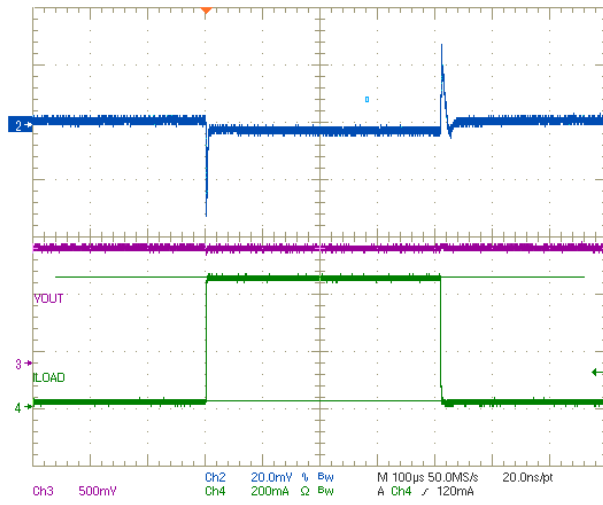

Figure 17 · Dynamic Response, $I_{Load} = 20mA$ to $450mA$

$V_{IN} = 1.2V$, $V_{BIAS} = 2.7V$, $V_{OUT} = 1V$
 CH2: V_{OUT} AC, CH3: V_{OUT} DC,
 CH4: Load Current

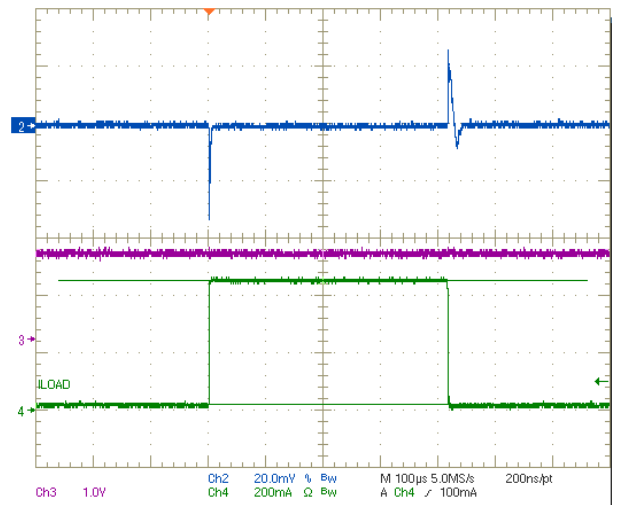

Figure 18 · Dynamic Response, $I_{Load} = 20mA$ to $450mA$

$V_{IN} = 1.8V$, $V_{BIAS} = 5V$, $V_{OUT} = 1.5V$
 CH2: V_{OUT} AC, CH3: V_{OUT} DC,
 CH4: Load Current

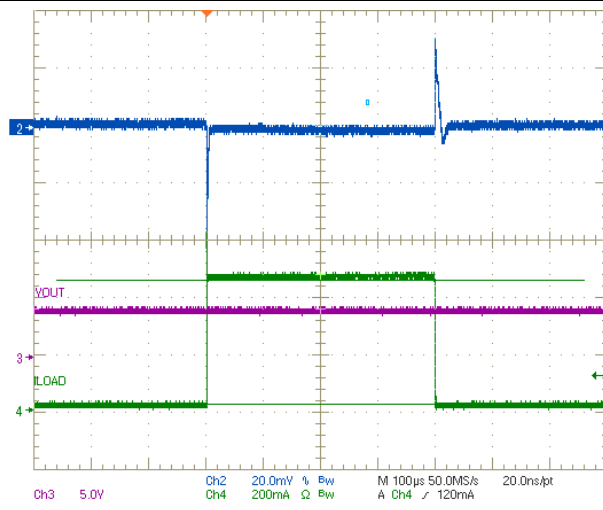

Figure 19 · Dynamic Response, $I_{Load} = 20mA$ to $450mA$

$V_{IN} = 4.2V$, $V_{BIAS} = 5.5V$, $V_{OUT} = 4V$
 CH2: V_{OUT} AC, CH3: V_{OUT} DC,
 CH4: Load Current

Theory of Operation / Application Information

BIAS pin operation

The IC uses a BIAS pin to allow low $R_{DS(on)}$. V_{BIAS} needs to be higher than V_{IN} by 1.3V to provide circuit headroom since there is no internal charge pump. The V_{BIAS} all insures the high V_{IN} – to – V_{OUT} PSRR, and the low noise performance is achieved with this topology at lower cost.

Adaptive PSRR compensation

LX8240 has internal adaptive feedforward control. A typical feedforward design depends on the zero from the external feedforward capacitance, C4 in Figure 20. In LX8240, the internal adaptive feedforward control circuit has an automatic pole compensator to allow different frequency inputs to experience a different zero frequency. This is equivalent to pole-zero pair in the control loop. This method allows LX8240 to maintain high gain over a very wide frequency range. Furthermore, it helps LX8240 sustain PSRR higher than 32dB over the entire frequency range up to 1MHz.

Setting the output Voltage

A typical LX8240 application circuit is shown in Figure 19. External component selection is driven by the load requirement. The LX8240 develops a 0.5V reference voltage between the feedback pin and the ground. The output voltage is set by a resistive divider according to the following formula:

$$V_{OUT} = 0.5 \times \left(1 + \frac{R1}{R2} \right)$$

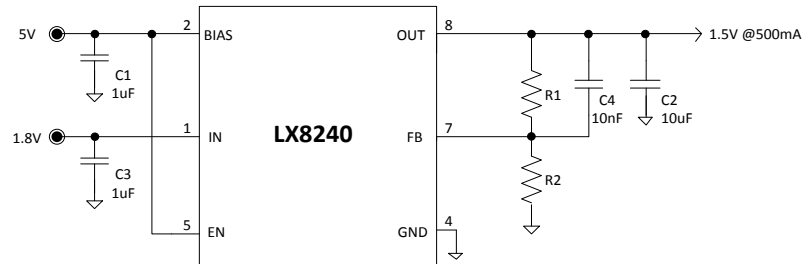

Figure 20 · Typical Application

PACKAGE OUTLINE DIMENSIONS

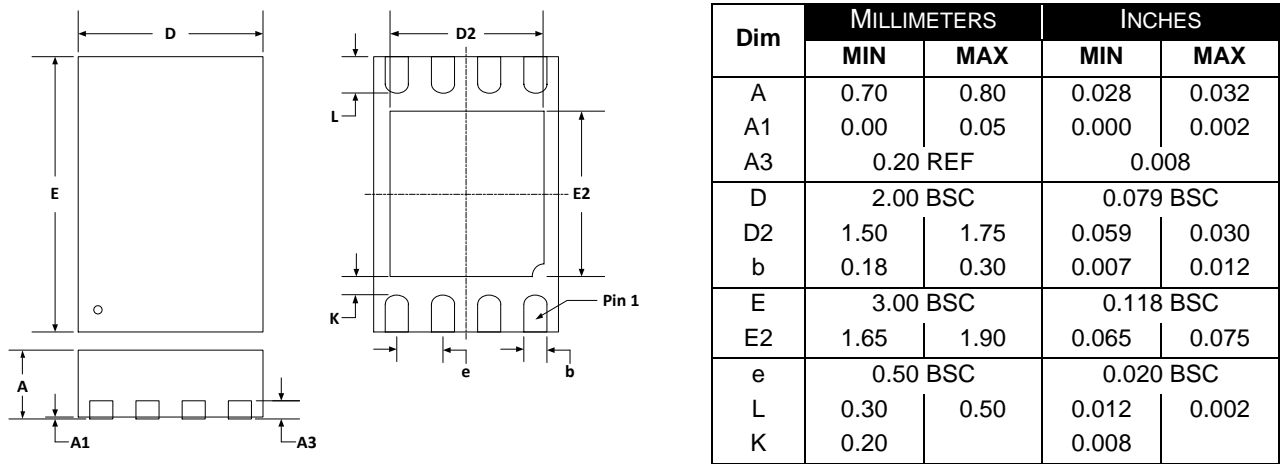

Figure 21 · LD 8-Pin WDFN Package Dimensions

Note: 1. Dimensions do not include mold flash or protrusions; these shall not exceed 0.155mm (.006”) on any side. Lead dimension shall not include solder coverage.

Note: 2. Dimensions are in mm, inches are for reference only.

LAND PATTERN RECOMMENDATION

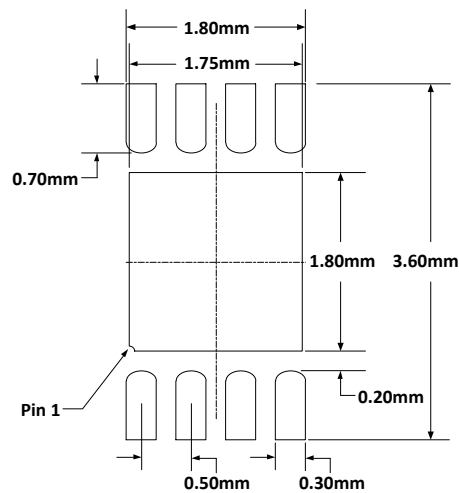

Figure 22 · LD 8-Pin WDFN Package Land Pattern

Disclaimer:

This PCB land pattern recommendation is based on information available to Microsemi by its suppliers. The actual land pattern to be used could be different depending on the materials and processes used in the PCB assembly, end user must account for this in their final layout. Microsemi makes no warranty or representation of performance based on this recommended land pattern.

PRODUCTION DATA – Information contained in this document is proprietary to Microsemi and is current as of publication date. This document may not be modified in any way without the express written consent of Microsemi. Product processing does not necessarily include testing of all parameters. Microsemi reserves the right to change the configuration and performance of the product and to discontinue product at any time.



Microsemi Corporate Headquarters
One Enterprise, Aliso Viejo CA 92656 USA
Within the USA: +1(949) 380-6100
Sales: +1 (949) 380-6136
Fax: +1 (949) 215-4996

Microsemi Corporation (NASDAQ: MSCC) offers a comprehensive portfolio of semiconductor solutions for: aerospace, defense and security; enterprise and communications; and industrial and alternative energy markets. Products include high-performance, high-reliability analog and RF devices, mixed signal and RF integrated circuits, customizable SoCs, FPGAs, and complete subsystems. Microsemi is headquartered in Aliso Viejo, Calif. Learn more at www.microsemi.com.

© 2013 Microsemi Corporation. All rights reserved. Microsemi and the Microsemi logo are trademarks of Microsemi Corporation. All other trademarks and service marks are the property of their respective owners.

X-ON Electronics

Largest Supplier of Electrical and Electronic Components

Click to view similar products for [LDO Voltage Regulators](#) category:

Click to view products by [Microsemi](#) manufacturer:

Other Similar products are found below :

[AP7363-SP-13](#) [L79M05TL-E](#) [PT7M8202B12TA5EX](#) [TCR3DF185,LM\(CT](#) [TCR3DF24,LM\(CT](#) [TCR3DF285,LM\(CT](#) [TCR3DF31,LM\(CT](#)
[TCR3DF45,LM\(CT](#) [MP2013GQ-33-Z](#) [059985X](#) [NCP4687DH15T1G](#) [701326R](#) [TCR2EN28,LF\(S](#) [NCV8170AXV250T2G](#)
[TCR3DF27,LM\(CT](#) [TCR3DF19,LM\(CT](#) [TCR3DF125,LM\(CT](#) [TCR2EN18,LF\(S](#) [AP2112R5A-3.3TRG1](#) [AP7315-25W5-7](#)
[IFX30081LDVGRNXUMA1](#) [NCV47411PAAJR2G](#) [AP2113KTR-G1](#) [AP2111H-1.2TRG1](#) [ZLDO1117QK50TC](#) [AZ1117IH-1.8TRG1](#)
[AZ1117ID-ADJTRG1](#) [TCR3DG12,LF](#) [MIC5514-3.3YMT-T5](#) [MIC5512-1.2YMT-T5](#) [MIC5317-2.8YM5-T5](#) [SCD7912BTG](#)
[NCP154MX180270TAG](#) [SCD33269T-5.0G](#) [NCV8170BMX330TCG](#) [NCV8170AMX120TCG](#) [NCP706ABMX300TAG](#)
[NCP153MX330180TCG](#) [NCP114BMX075TCG](#) [MC33269T-3.5G](#) [CAT6243-ADJCMT5T](#) [TCR3DG33,LF](#) [AP2127N-1.0TRG1](#)
[TCR4DG35,LF](#) [LT1117CST-3.3](#) [LT1117CST-5](#) [TAR5S15U\(TE85L,F\)](#) [TAR5S18U\(TE85L,F\)](#) [TCR3UG19A,LF](#) [TCR4DG105,LF](#)