



## Silicon 3.0 Watt Zener Diode

### DESCRIPTION

The SMAJ5913Be3 – SMAJ5956Be3 series of surface mount 3.0 watt Zeners provides voltage regulation in a selection from 3.3 to 200 volts with different tolerances as identified by suffix letter on the part number. It is equivalent to the JEDEC registered 1N5913B through 1N5956B series with identical electrical characteristics except it is rated at 3.0 W instead of 1.5 W with the lower thermal resistance features of this surface mount packaging. These plastic encapsulated Zeners have a moisture classification of Level 1 with no dry pack required.

**Important:** For the latest information, visit our website <http://www.microsemi.com>.

### FEATURES

- Ideal for high-density and low-profile mounting.
- Zener voltage available 3.3V to 200V.
- Available voltage tolerances are 10%, 5%, 2%, and 1%.
- RoHS compliant.

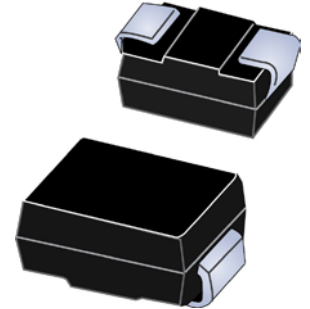
### APPLICATIONS / BENEFITS

- Regulates voltage over a broad range of current and temperature.
- Nonsensitive to ESD per MIL-STD-750 method 1020.
- High specified maximum current ( $I_{ZM}$ ) with adequately heat sinking.
- Moisture classification is Level 1 with no dry pack required per IPC/JEDEC J-STD-020B.

### MAXIMUM RATINGS

Parameters/Test Conditions	Symbol	Value	Unit
Junction and Storage Temperature	$T_J$ and $T_{STG}$	-65 to +150	°C
Thermal Resistance Junction-to-Lead	$R_{\theta JL}$	15	°C/W
Thermal Resistance Junction-to-Ambient <sup>(1)</sup>	$R_{\theta JA}$	80	°C/W
Rated Average Power Dissipation @ +25 °C (also see derating in <a href="#">Figure 1</a> )	$P_{M(AV)}$	3.0	W
Forward Voltage @ 200 mA	$V_F$	1.2	V
Solder Temperature @ 10 s	$T_{SP}$	260	°C

**Notes:** 1. When mounted on FR4 PC board (1oz Cu) with recommended footprint (see [last page](#)).



**DO-214AC or BA  
(SMAJ) Package**

Also available in:

**DO-41 package**

(plastic axial leaded)



[1N5913BP – 1N5956BP](#)

**DO-216 package**

(tabbed surface mount)



[1PMT5913B – 1PMT5956B](#)

#### **MSC – Lawrence**

6 Lake Street,  
Lawrence, MA 01841  
Tel: 1-800-446-1158 or  
(978) 620-2600  
Fax: (978) 689-0803

#### **MSC – Ireland**

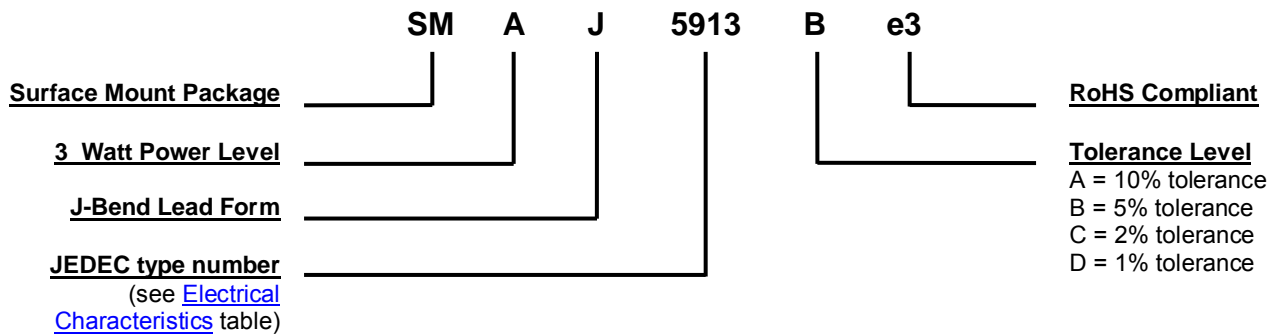
Gort Road Business Park,  
Ennis, Co. Clare, Ireland  
Tel: +353 (0) 65 6840044  
Fax: +353 (0) 65 6822298

**Website:**

[www.microsemi.com](http://www.microsemi.com)

**MECHANICAL and PACKAGING**

- CASE: Void-free transfer molded thermosetting epoxy body meeting UL94V-0.
- TERMINALS: RoHS compliant annealed matte-tin plating. Solderable to MIL-STD-750, method 2026.
- MARKING: Includes part number without prefix (e.g. 5913B, 5916Be3, 5926C, 5951De3, etc.).
- POLARITY: Cathode indicated by band. Diode to be operated with the banded end positive with respect to the opposite end for Zener regulation.
- TAPE & REEL option: Standard per EIA-481-1-A with 12 mm tape (add “TR” suffix to part number). Consult factory for quantities.
- WEIGHT: Approximately 0.064 grams.
- See [Package Dimensions](#) on last page.

**PART NOMENCLATURE**

**SYMBOLS & DEFINITIONS**

Symbol	Definition
$I_R$	Reverse Current: The maximum reverse (leakage) current that will flow at the specified voltage $V_R$ and temperature.
$I_Z, I_{ZT}, I_{ZK}$	Regulator Current: The dc regulator current ( $I_Z$ ), at a specified test point ( $I_{ZT}$ ), near breakdown knee ( $I_{ZK}$ ).
$I_{ZM}$	Maximum Regulator (Zener) Current: The maximum rated dc current for the specified power rating.
$V_F$	Maximum Forward Voltage: The maximum forward voltage the device will exhibit at a specified current.
$V_R$	Reverse Voltage: The dc voltage applied in the reverse direction below the breakdown region.
$V_Z$	Zener Voltage: The Zener voltage the device will exhibit at a specified current ( $I_Z$ ) in its breakdown region.
$Z_{ZT}$ or $Z_{ZK}$	Dynamic Impedance: The small signal impedance of the diode when biased to operate in its breakdown region at a specified mms current modulation (typically 10% of $I_{ZT}$ or $I_{ZK}$ ) and superimposed on $I_{ZT}$ or $I_{ZK}$ respectively.

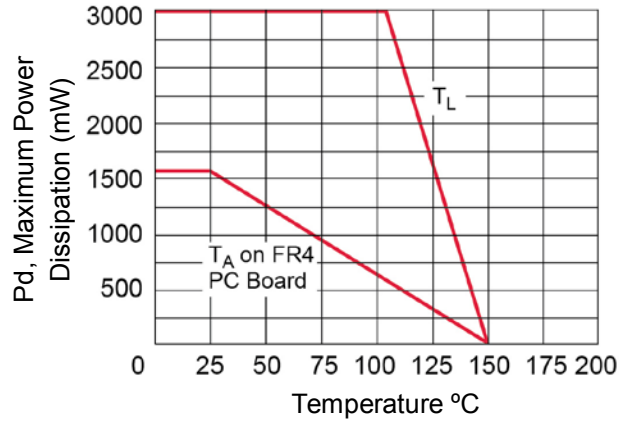
**ELECTRICAL CHARACTERISTICS @ 25 °C unless otherwise stated**

JEDEC TYPE NUMBER	ZENER VOLTAGE $V_Z$	TEST CURRENT $I_{ZT}$	DYNAMIC IMPEDANCE $Z_{ZT}$	KNEE CURRENT $I_{ZK}$	KNEE IMPEDANCE $Z_{ZK}$	REVERSE CURRENT $I_R$ (MAX.)	REVERSE VOLTAGE $V_R$	MAX. DC CURRENT $I_{ZM}$
	Volts	mA	Ohms	mA	Ohms	$\mu$ A	Volts	mA
SMAJ5913B	3.3	113.6	10	1.0	500	100	1.0	908
SMAJ5914B	3.6	104.2	9.0	1.0	500	75	1.0	832
SMAJ5915B	3.9	96.1	7.5	1.0	500	25	1.0	768
SMAJ5916B	4.3	87.2	6.0	1.0	500	5.0	1.0	696
SMAJ5917B	4.7	79.8	5.0	1.0	500	5.0	1.5	638
SMAJ5918B	5.1	73.5	4.0	1.0	350	5.0	2.0	588
SMAJ5919B	5.6	66.9	2.0	1.0	250	5.0	3.0	534
SMAJ5920B	6.2	60.5	2.0	1.0	200	5.0	4.0	482
SMAJ5921B	6.8	55.1	2.5	1.0	200	5.0	5.2	440
SMAJ5922B	7.5	50	3.0	0.5	400	5.0	6.0	400
SMAJ5923B	8.2	45.7	3.5	0.5	400	5.0	6.5	364
SMAJ5924B	9.1	41.2	4.0	0.5	500	5.0	7.0	328
SMAJ5925B	10	37.5	4.5	0.25	500	5.0	8.0	300
SMAJ5926B	11	34.1	5.5	0.25	550	1.0	8.4	272
SMAJ5927B	12	31.2	6.5	0.25	550	1.0	9.1	250
SMAJ5928B	13	28.8	7.0	0.25	550	1.0	9.9	230
SMAJ5929B	15	25	9.0	0.25	600	1.0	11.4	200
SMAJ5930B	16	23.4	10	0.25	600	1.0	12.2	186
SMAJ5931B	18	20.8	12	0.25	650	1.0	13.7	166
SMAJ5932B	20	18.7	14	0.25	650	1.0	15.2	150
SMAJ5933B	22	17	17.5	0.25	650	1.0	16.7	136
SMAJ5934B	24	15.6	19	0.25	700	1.0	18.2	124
SMAJ5935B	27	13.9	23	0.25	700	1.0	20.6	110
SMAJ5936B	30	12.5	28	0.25	750	1.0	22.8	100
SMAJ5937B	33	11.4	33	0.25	800	1.0	25.1	90
SMAJ5938B	36	10.4	38	0.25	850	1.0	27.4	82
SMAJ5939B	39	9.6	45	0.25	900	1.0	29.7	76
SMAJ5940B	43	8.7	53	0.25	950	1.0	32.7	68
SMAJ5941B	47	8.0	67	0.25	1000	1.0	35.8	62
SMAJ5942B	51	7.3	70	0.25	1100	1.0	38.8	58
SMAJ5943B	56	6.7	86	0.25	1300	1.0	42.6	52
SMAJ5944B	62	6.0	100	0.25	1500	1.0	47.1	48
SMAJ5945B	68	5.5	120	0.25	1700	1.0	51.2	44
SMAJ5946B	75	5.0	140	0.25	2000	1.0	56	40
SMAJ5947B	82	4.6	160	0.25	2500	1.0	62.2	36
SMAJ5948B	91	4.1	200	0.25	3000	1.0	69.2	32
SMAJ5949B	100	3.7	250	0.25	3100	1.0	76	30
SMAJ5950B	110	3.4	300	0.25	4000	1.0	83.6	26
SMAJ5951B	120	3.1	380	0.25	4500	1.0	91.2	24
SMAJ5952B	130	2.9	450	0.25	5000	1.0	98.8	22
SMAJ5953B	150	2.5	600	0.25	6000	1.0	114	20
SMAJ5954B	160	2.3	700	0.25	6500	1.0	121.6	18
SMAJ5955B	180	2.1	900	0.25	7000	1.0	136.8	16
SMAJ5956B	200	1.9	1200	0.25	8000	1.0	152	14

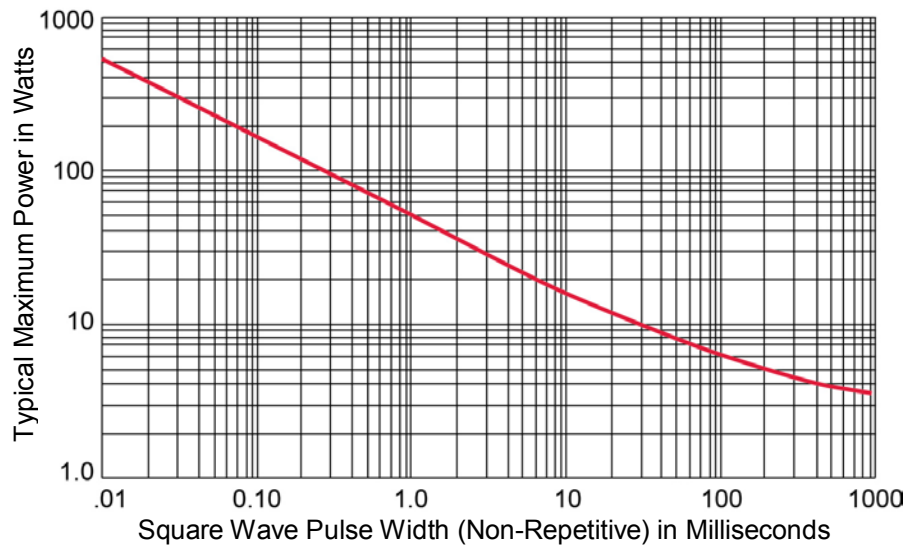
**NOTES:**

- Suffix B (shown) denotes a +/-5% tolerance on nominal  $V_Z$ , A denotes a +/-10% tolerance, C denotes a 2% tolerance, and D denotes a +/-1% tolerance.
- Zener voltage ( $V_Z$ ) is measured at  $T_L = 30^\circ\text{C}$  and 90 seconds after application of dc current.
- The Zener impedance is derived from the 60 Hz ac voltage, which results when an ac current having an rms value equal to 10% of the dc Zener current ( $I_{ZT}$  or  $I_{ZK}$ ) is superimposed on  $I_{ZT}$  or  $I_{ZK}$ .
- The maximum dc current ( $I_{ZM}$ ) is based only on the maximum power of 3.0 watts at  $T_L \leq 105^\circ\text{C}$ . These values must be reduced by 48% (1.56 W) when mounted on PC boards as described in [Maximum Ratings](#).

GRAPHS

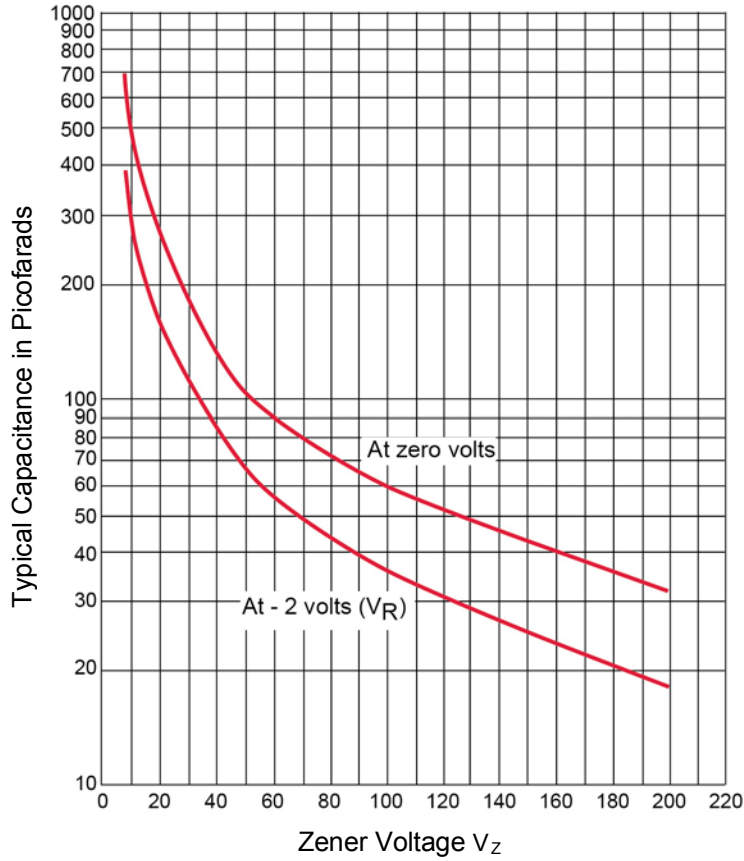


**FIGURE 1**  
POWER DERATING CURVE

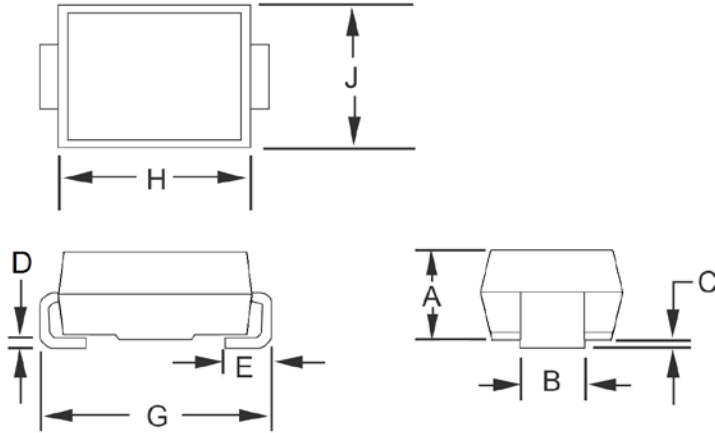


**FIGURE 2**  
TRANSIENT SURGE CAPABILITY

GRAPHS

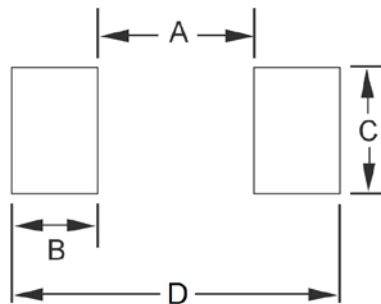


**FIGURE 3**  
CAPACITANCE vs.  $V_Z$  CURVE

**PACKAGE DIMENSIONS**


Ltr	Dimensions			
	Inch		Millimeters	
	Min	Max	Min	Max
<b>A</b>	0.075	0.089	1.90	2.25
<b>B</b>	0.050	0.064	1.27	1.63
<b>C</b>	0.004	0.008	0.10	0.20
<b>D</b>	0.006	0.012	0.15	0.31
<b>E</b>	0.031	0.059	0.80	1.50
<b>G</b>	0.189	0.205	4.80	5.20
<b>H</b>	0.157	0.181	4.00	4.60
<b>J</b>	0.095	0.104	2.40	2.65

**NOTES:** Dimension "A" is within DO-214BA but higher than DO-214AC standard JEDEC outlines.  
Dimension "B" is wider than both JEDEC outlines for lower thermal resistance.

**PAD LAYOUT**


Ltr	Inch	Millimeters
<b>A (MAX)</b>	0.074	2.413
<b>B (MIN)</b>	0.060	1.52
<b>C (MIN)</b>	0.066	1.68
<b>D (TYP)</b>	0.208	5.28

## X-ON Electronics

Largest Supplier of Electrical and Electronic Components

*Click to view similar products for [Zener Diodes](#) category:*

*Click to view products by [Microsemi](#) manufacturer:*

Other Similar products are found below :

[RKZ13B2KG#P1](#) [DL5234B](#) [1N4682](#) [1N4691](#) [1N4693](#) [1N4732A](#) [1N4733A-TR](#) [1N4736A](#) [1N4759ARL](#) [1N5241B](#) [1N5365B](#) [1N5369B](#)  
[1N959B](#) [1N964B](#) [1N966B](#) [1N972B](#) [NTE149A](#) [NTE5116A](#) [NTE5121A](#) [NTE5147A](#) [NTE5152A](#) [NTE5155A](#) [NTE5164A](#) [JANS1N4974US](#)  
[1N4692](#) [1N4700](#) [1N4702](#) [1N4704](#) [1N4711](#) [1N4714](#) [1N4737A](#) [1N4745ARL](#) [1N4752A](#) [1N4752ARL](#) [1N4760ARL](#) [1N5221B](#) [1N5236B](#)  
[1N5241BTR](#) [1N5242BTR](#) [1N5350B](#) [1N5352B](#) [1N961BRR1](#) [1N964BRL](#) [RKZ5.1BKU#P6](#) [3SMAJ5950B-TP](#) [3SMBJ5925B-TP](#) [TDZTR24](#)  
[441774C](#) [MMSZ5230BQ-13-F](#) [MMSZ5232BQ-13-F](#)