

The logo features a stylized graphic of three slanted bars in red, green, and blue. To the right of this graphic, the word "Microtips" is written in a large, bold, black serif font. Below "Microtips", a thick horizontal black line spans the width of the text. Underneath this line, the word "TECHNOLOGY" is written in a smaller, black, all-caps serif font with wide letter spacing.

**Microtips**  
**TECHNOLOGY**

Model No: MT06G HPZ0

TEL: 1-888-499-TIPS (8477)

FAX: (407) 273-0771

E-MAIL: [mtusainfo@microtipsusa.com](mailto:mtusainfo@microtipsusa.com)

WEB: [www.microtipsusa.com](http://www.microtipsusa.com)

## Record of Revision

Date	Revision No.	Summary
2012-01-12	1.0	Rev 1.0 was issued
2012-12-24	1.1	Change the IC. Update interface

1. Scope

This data sheet is to introduce the specification of **MTD0283HZG** active matrix TFT module. It is composed of a color TFT-LCD panel, driver ICs, FPC, and a backlight unit. The 2.83" display area contains 240(RGB) x 320 pixels.

2. Application

Digital equipments which need color display, mobile phone, mobile navigator/video systems.

3. General Information

Item	Contents	Unit
Size	2.83	inch
Resolution	240(RGB) x 320	/
Interface	18bits CPU	/
Technology type	HFFS TFT	/
Pixel pitch	0.18x0.18	mm
Pixel Configuration	R.G.B Vertical Stripe	
Outline Dimension (W x H x D)	48.4x81.5x3.25	mm
Active Area	41.76x 69.60	mm
Display Mode	Transmissive Normally Black	/
Backlight Type	LED	/
Driver IC	ILI9341	/

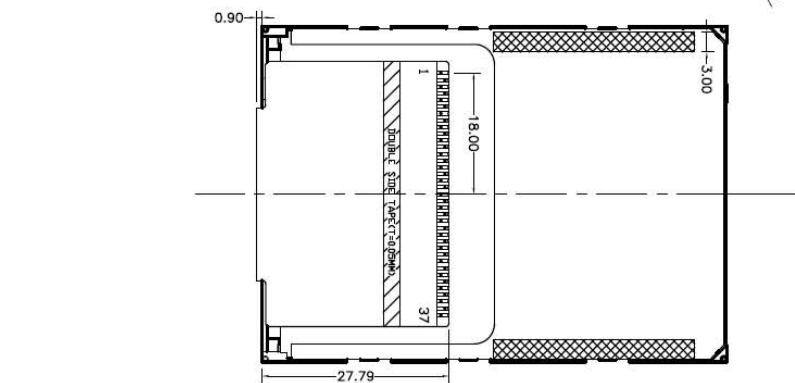
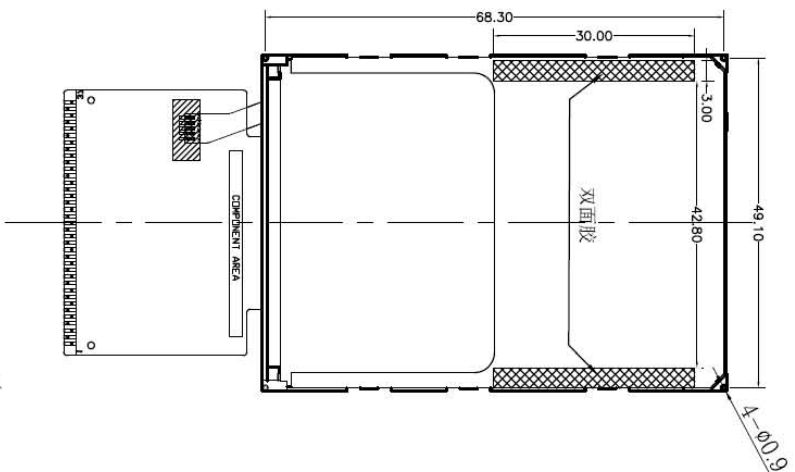
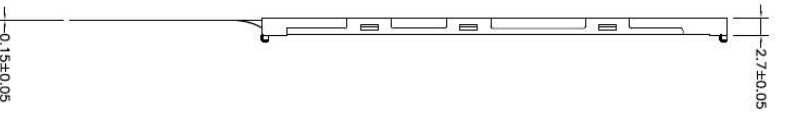
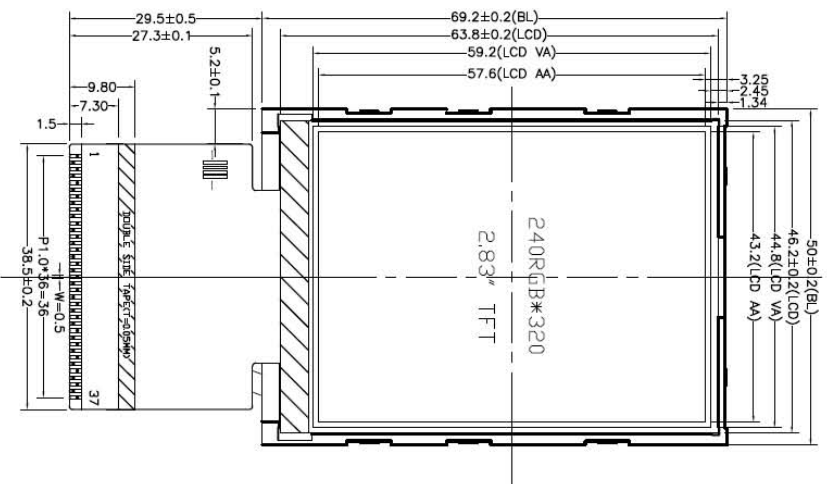

1	DB1
2	DB2
3	DB3
4	DB4
5	GND
6	VDD
7	CS
8	RS
9	WR
10	RD
11	NC
12	X+
13	Y+
14	X-
15	Y-
16	LEDA
17	LEDK1
18	LEDK2
19	LEDK3
20	LEDK4
21	NC
22	DB5
23	DB10
24	DB11
25	DB12
26	DB13
27	DB14
28	DB15
29	DB16
30	DB17
31	RESET
32	VDD
33	VDD
34	GND
35	DB6
36	DB7
37	DB8

LED CIRCUIT

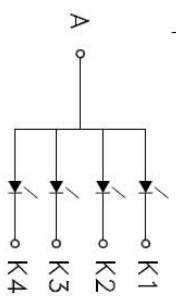

- NOTES:
1. DISPLAY TYPE : 2.83 TFT
  2. POLARIZER MODE : TRANSMISSIVE/NEGATIVE
  3. VIEWING DIRECTION: : Free viewing direction
  4. MAIN LCD BACKLIGHT : 4-CHIP WHITE LED PARALLEL
  5. OPERATING TEMP : -20°C~70°C
  6. STORAGE TEMP : -30°C~80°C
  7. DRIVER IC : ILI9341
  8. LED OPERATING VOLTAGE : 3.2 V

**Microtips**  
TECHNOLOGY

DRAWN BY:	TITLE: <b>AH8 \$&amp;, &lt;N;</b>	SCALE:	UNIT: mm
CHECKED BY:	DWG NO: V1.1	SCALE:	UNIT: mm
APPROVED BY:	DWG NAME:	SHEET NO:	OF
CONFERRED BY:			

5. Interface signals

No	Symbol	I/O	Description	Remarks
1	DB1	I	Data input	
2	DB2	I	Data input	
3	DB3	I	Data input	
4	DB4	I	Data input	
5	GND	P	Ground	
6	VDD	P	Power Supply	
7	/CS	I	A chip select signal	
8	RS	I	A register select signal	
9	/WR	I	A write strobe signal and actives when the signal is low	
10	/RD	I	A read strobe signal and actives when the signal is low	
11	NC	I	No Connect	
12	X+	I	Touch panel pin	
13	Y+	I	Touch panel pin	
14	X-	I	Touch panel pin	
15	Y-	I	Touch panel pin	
16	LED-A	I	LED anode	
17	LED-K1	I	LED cathode	
18	LED-K2	I	LED cathode	
19	LED-K3	I	LED cathode	
20	LED-K4	I	LED cathode	
21	NC	I	No Connect	
22	DB5	I	Data input	
23	DB10	I	Data input	
24	DB11	I	Data input	
25	DB12	I	Data input	
26	DB13	I	Data input	
27	DB14	I	Data input	
28	DB15	I	Data input	
29	DB16	I	Data input	
30	DB17	I	Data input	
31	/RESET	I	A RESET signal	
32	VDD	P	Power Supply	
33	VDD	P	Power Supply	
34	GND	P	Ground	
35	DB6	I	Data input	
36	DB7	I	Data input	
37	DB8	I	Data input	

## 6. Absolute maximum Ratings

### 6.1. Electrical Absolute max. ratings

Parameter	Symbol	MIN	MAX	Unit	Remark
Logic Supply Voltage	IOVCC	-0.3	4.6	V	
Analog Supply Voltage	VCC	-0.3	4.6	V	
Input Voltage	VIN	-0.3	IOVCC +0.3	V	

### 6.2. Environment Conditions

Item	Symbol	MIN	MAX	Unit	Remark
Operating Temperature	TOPR	-20	70	°C	
Storage Temperature	TSTG	-30	80	°C	

### 6.3. LED Backlight Absolute max. ratings

Item	Symbol	MIN	MAX	Unit	Remark
LED Forward Current	ILED	--	25	mA	For each LED

## 7. Electrical Specifications

### 7.1 Electrical characteristics

GND=0V, Ta=25°C

Item	Symbol	MIN	TYP	MAX	Unit	Remark
Logic Supply Voltage	IOVCC	1.65	2.8	3.3	V	
Analog Supply Voltage	VDD	2.3	2.8	3.3	V	
Input Signal Voltage	VIL	-0.3	--	0.2*IOVCC	V	Note
	VIH	0.8*IOVCC	--	IOVCC	V	
Output Signal Voltage	VOL	-0.3	--	0.3*IOVCC	V	
	VOH	0.7*IOVCC	--	IOVCC	V	

### 7.2 LED Backlight

Ta=25°C

Item	Symbol	MIN	TYP	MAX	Unit	Remark
Forward Current	IF	-	20	25	mA	Each LED
Forward Voltage	VF	-	3.2	-	V	

Note1: Figure below shows the connection of backlight LED.

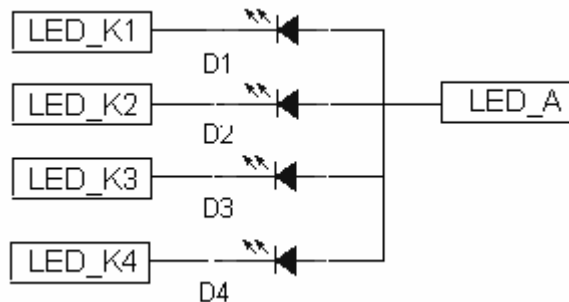

7.3 Block Diagram

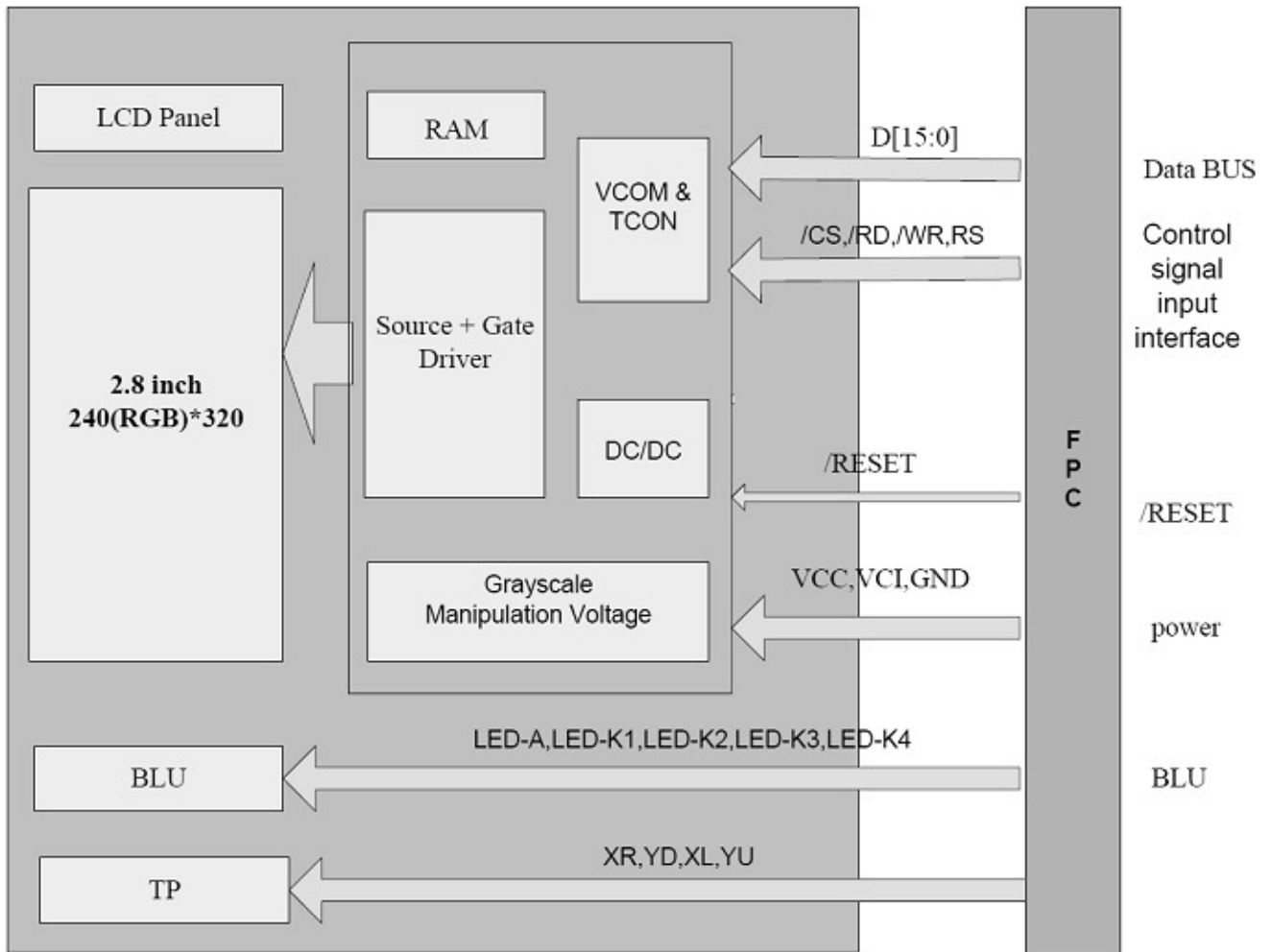



## 8. Command/AC Timing

### 8.1 CPU Interface Timing

Signal	Symbol	Parameter	Min	Max	Unit
RS	t <sub>ast</sub>	Address setup time	0	-	ns
	t <sub>aht</sub>	Address hold time(Write/Read)	10	-	ns
CS	t <sub>cs</sub>	Chip Select setup time(Write)	15	-	ns
	t <sub>r<sub>cs</sub></sub>	Chip Select setup time(Read)	45	-	ns
	t <sub>csf</sub>	Chip Select Wait time(Write/Read)	10	-	ns
WR	t <sub>wc</sub>	Write cycle	66	-	ns
	t <sub>wrh</sub>	Write Control pulse H duration	15	-	ns
	t <sub>wrl</sub>	Write Control pulse L duration	15	-	ns
RD	t <sub>rc</sub>	Read cycle	160	-	ns
	t <sub>rdh</sub>	Read Control pulse H duration	90	-	ns
	t <sub>rdl</sub>	Read Control pulse L duration	45	-	ns
DB[17:0]	t <sub>wds</sub>	Write data setup time	10	-	ns
DB[15:0]	t <sub>wdh</sub>	Write data hold time	10	-	ns
DB[8:0]	t <sub>r<sub>acc</sub></sub>	Read access time	-	340	ns
DB[7:0]	t <sub>rod</sub>	Read output disable time	20	80	ns

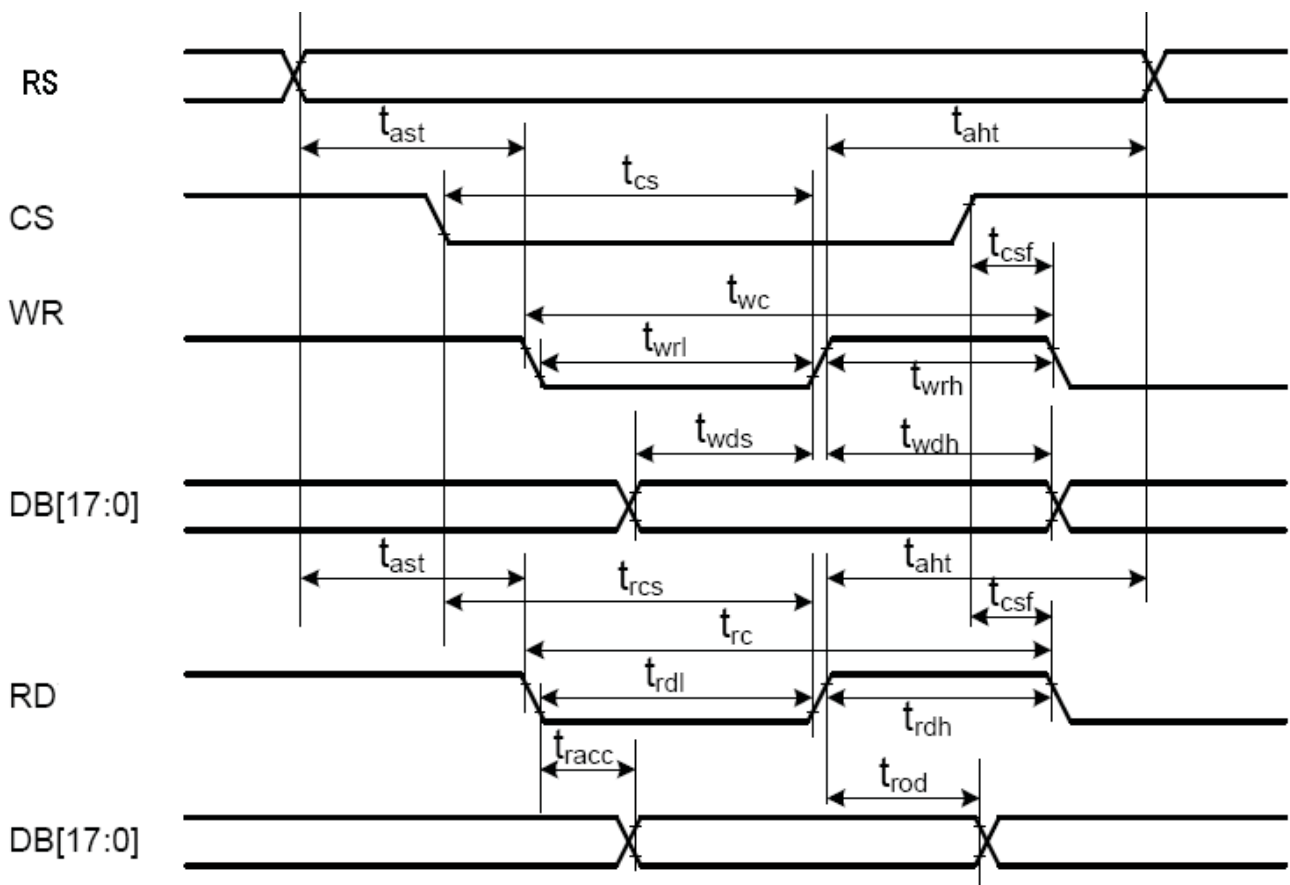

9. Optical Specification

Ta=25°C

Item	Symbol	Condition	Min	Typ.	Max.	Unit	Remark
Contrast Ratio	CR	$\theta=0^\circ$	400	500	-		Note1 Note2
Response Time	Ton/ Toff	25°C	-	35	45	ms	Note1 Note3
View Angles	$\theta T$	$CR \geq 10$	70	80	-	Degree	Note 4
	$\theta B$		70	80	-		
	$\theta L$		70	80	-		
	$\theta R$		70	80	-		
Chromaticity	White	Brightness is on	x	0.26	0.30	0.34	Note5, Note1
			y	0.27	0.31	0.36	
NTSC	S		67	70		%	Note5
Luminance	L		180	220	-	cd/m <sup>2</sup>	Note1 Note6
Uniformity	U		-	80	-	%	Note1 Note7

Test condition:  $V_F=3.2V$ ,  $I_F=15mA$ , the ambient temperature is 25°C.

**Note 1: Definition of optical measurement system.**

Temperature = 25°C(±3°C)

LED back-light: ON, Environment brightness < 150 lx

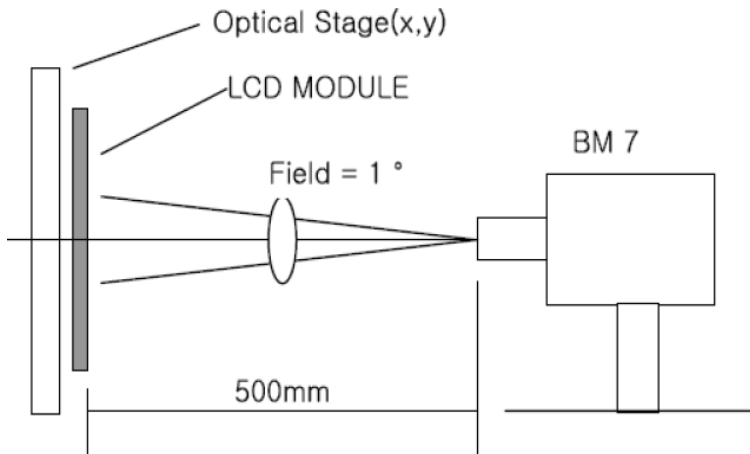

**Note 2: Contrast ratio is defined as follow:**

$$\text{Contrast Ratio} = \frac{\text{Surface Luminance with all white pixels}}{\text{Surface Luminance with all black pixels}}$$

**Note 3: Response time is defined as follow:**

Response time is the time required for the display to transition from black to white (Rise Time,  $T_r$ ) and from white to black (Decay Time,  $T_f$ ).

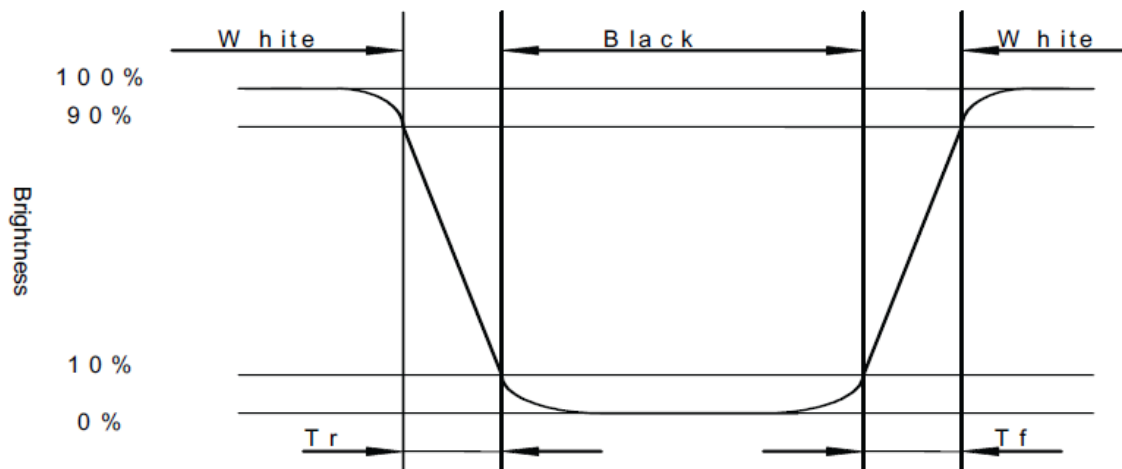

Note 4: Viewing angle range is defined as follow:

Viewing angle is measured at the center point of the LCD.

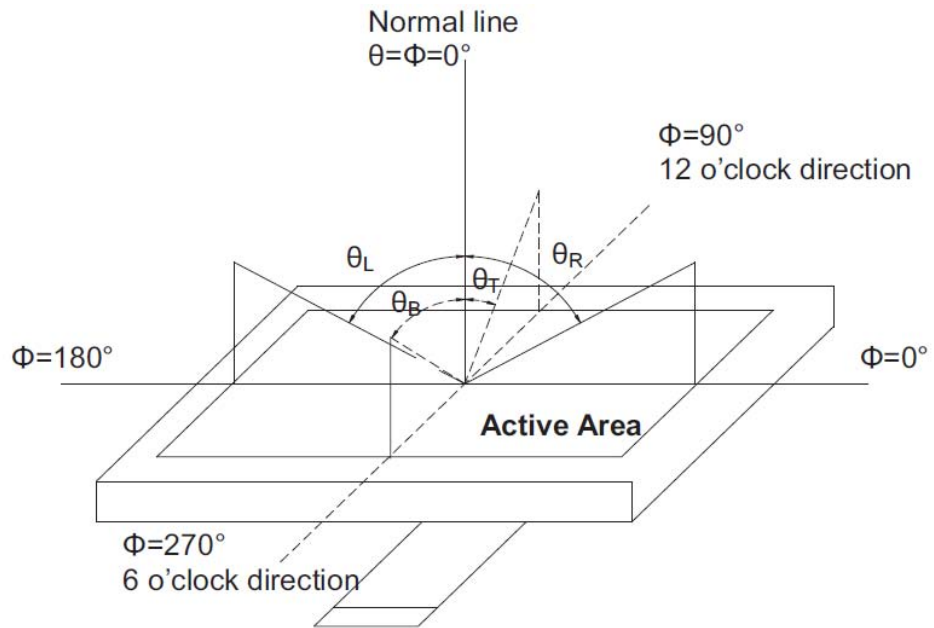

Note 5: Color chromaticity is defined as follow: (CIE1931)

Color coordinates measured at center point of LCD.

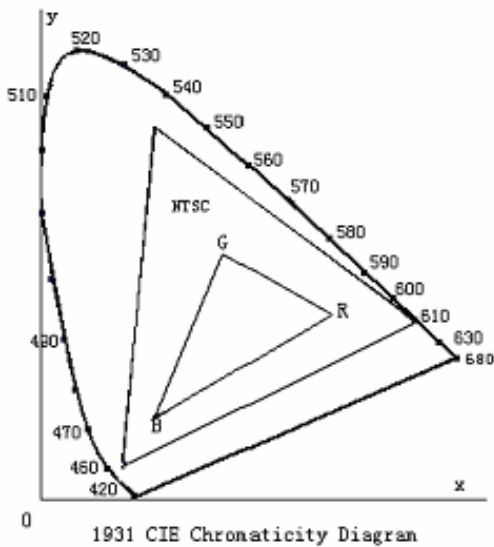

$$S = \frac{\text{area of RGB triangle}}{\text{area of NTSC triangle}} \times 100\%$$

Note 6: Luminance is defined as follow:

Luminance is defined as the brightness of all pixels “White” at the center of display area on optimum contrast.

Note 7: Luminance Uniformity is defined as follow:

Active area is divided into 9 measuring areas (Refer Fig. 2). Every measuring point is placed at the center of each measuring area.

$$\text{Uniformity (U)} = \frac{\text{Minimum Luminance (brightness) in 9 points}}{\text{Maximum Luminance (brightness) in 9 points}}$$

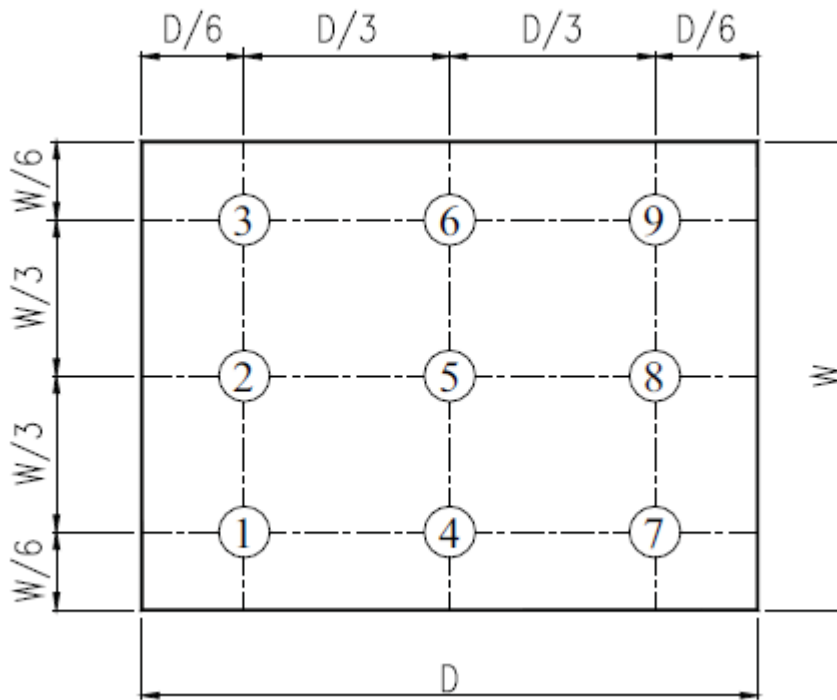

Fig. 2 Definition of uniformity

10. Environmental / Reliability Tests

No	Test Item	Condition	Judgment criteria
1	High Temp Operation	Ts=+60°C, 120hrs	Per table in below
2	Low Temp Operation	Ta=-20°C, 120hrs	Per table in below
3	High Temp Storage	Ta=+70°C, 120hrs	Per table in below
4	Low Temp Storage	Ta=-30°C, 120hrs	Per table in below
5	High Temp & High Humidity Storage	Ta=+60°C, 90% RH 120 hours	Per table in below (polarizer discoloration is excluded)
6	Thermal Shock (Non-operation)	-30°C 30 min~+70°C 30 min, Change time:5min, 10 Cycles	Per table in below
7	ESD (Operation)	C=150pF, R=330Ω , 5points/panel Air:±8KV, 5times; Contact:±4KV, 5 times;	Per table in below
8	Vibration (Non-operation)	Frequency range:10~55Hz, Stroke:1.5mm Sweep:10Hz~55Hz~10Hz 2 hours for each direction of X.Y.Z.	Per table in below
9	Shock (Non-operation)	60G 6ms, ±X,±Y,±Z 3times, for each direction	Per table in below
10	Package Drop Test	Height:80 cm, 1 corner, 3 edges, 6 surfaces	Per table in below

INSPECTION	CRITERION(after test)
Appearance	No Crack on the FPC, on the LCD Panel
Alignment of LCD Panel	No Bubbles in the LCD Panel No other Defects of Alignment in Active area
Electrical current	Within device specifications
Function / Display	No Broken Circuit, No Short Circuit or No Black line No Other Defects of Display

## 11. Precautions for Use of LCD Modules

### 11.1 Safety

The liquid crystal in the LCD is poisonous. Do not put it in your mouth. If the liquid crystal touches your skin or clothes, wash it off immediately using soap and water.

### 11.2 Handling

- A. The LCD and touch panel is made of plate glass. Do not subject the panel to mechanical shock or to excessive force on its surface.
- B. Do not handle the product by holding the flexible pattern portion in order to assure the reliability
- C. Transparency is an important factor for the touch panel. Please wear clear finger sacks, gloves and mask to protect the touch panel from finger print or stain and also hold the portion outside the view area when handling the touch panel.
- D. Provide a space so that the panel does not come into contact with other components.
- E. To protect the product from external force, put a covering lens (acrylic board or similar board) and keep an appropriate gap between them.
- F. Transparent electrodes may be disconnected if the panel is used under environmental conditions where dew condensation occurs.
- G. Property of semiconductor devices may be affected when they are exposed to light, possibly resulting in IC malfunctions.
- H. To prevent such IC malfunctions, your design and mounting layout shall be done in the way that the IC is not exposed to light in actual use.

### 11.3 Static Electricity

- A. Ground soldering iron tips, tools and testers when they are in operation.
- B. Ground your body when handling the products.
- C. Power on the LCD module before applying the voltage to the input terminals.
- D. Do not apply voltage which exceeds the absolute maximum rating.
- E. Store the products in an anti-electrostatic bag or container.

### 11.4 Storage

- A. Store the products in a dark place at  $+25^{\circ}\text{C} \pm 10^{\circ}\text{C}$  with low humidity (40% RH to 60% RH). Don't expose to sunlight or fluorescent light.
- B. Storage in a clean environment, free from dust, active gas, and solvent.

### 11.5 Cleaning

- A. Do not wipe the touch panel with dry cloth, as it may cause scratch.
- B. Wipe off the stain on the product by using soft cloth moistened with ethanol. Do not allow ethanol to get in between the upper film and the bottom glass. It may cause peeling issue or defective operation. Do not use any organic solvent or detergent other than ethanol.

### 11.6 Cautions for installing and assembling

Bezel edge must be positioned in the area between the Active area and View area. The bezel may press the touch screen and cause activation if the edge touches the active area. A gap of approximately 0.5mm is needed between the bezel and the top electrode. It may cause unexpected activation if the gap is too narrow. There is a tolerance of 0.2 to 0.3mm for the outside dimensions of the touch panel and tail. A gap must be made to absorb the tolerance in the case and connector.

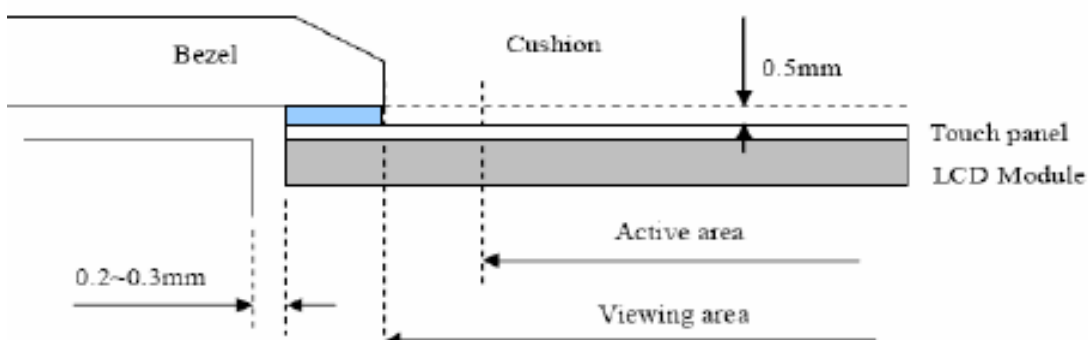

## X-ON Electronics

Largest Supplier of Electrical and Electronic Components

*Click to view similar products for [TFT Displays & Accessories category](#):*

*Click to view products by [Microtips manufacturer](#):*

Other Similar products are found below :

[F3ET2-005-150](#) [HDA430T-3G1H](#) [NL6448BC20-21D](#) [NB7W-KBA04](#) [NB-ATT01](#) [NB5Q-ATT01](#) [NB5Q-KBA04](#) [NB-CN001](#) [OAI-80038AA-2008-A](#) [315-U004B15300](#) [UMSH-8596MD-34T \(REV D\)](#) [TCG121WXLRXVNNANX35](#) [EIC-LCD-1080P](#) [T-55619GD065J-LW-ABN](#) [TCG104SVLPEANN-AN30](#) [NL6448BC33-70](#) [NL6448BC20-30D](#) [NL10276BC16-06](#) [NL192108AC10-01D](#) [NL12880BC20-05BD](#) [NL8060BC26-35BA](#) [NL8060BC31-50F](#) [TM070DDHG03-40](#) [NL10276AC30-42C](#) [PTPW16-070WV1S02](#) [PTPW17-070WV1S02](#) [PTPW16-084SV1S02](#) [MTD0300ECP06DF-1](#) [DEM 320240T VMX-PW-N \(A-TOUCH\)](#) [DEM 480128B TMH-PW-N \(A-TOUCH\)](#) [DEM 480272P VMX-PW-N \(C-TOUCH\)](#) [DEM 480272Q VMX-PW-N \(A-TOUCH\)](#) [DEM 480272Q VMX-PW-N \(C-TOUCH\)](#) [DEM 640480E TMH-PW-N \(A-TOUCH\)](#) [DEM 800480K1 TMH-PW-N \(A-TOUCH\)](#) [DEM 800480K1 TMH-PW-N \(C-TOUCH\)](#) [DEM 800480K2 TMH-PW-N \(A-TOUCH\)](#) [DEM 800480K3 TMH-PW-N \(C-TOUCH\)](#) [DEM 800480K4 TMH-PW-N \(A-TOUCH\)](#) [DEM 800480K4 TMH-PW-N \(C-TOUCH\)](#) [4DLCD-35480320-CTP-IPS](#) [4DLCD-35480320-IPS](#) [4DLCD-35480320-RTP-IPS](#) [4DLCD-50800480-CTP-IPS](#) [RFA6400E-AWH-DNG](#) [RFA6400E-AWH-MNN](#) [RFE430V-AZW-DNS](#) [RFF70VA2-1IW-DHS](#) [RFH700A8-AYH-MNN](#) [RFK101VF-1YH-LHG](#)