

The logo features a stylized graphic of three slanted bars in red, green, and blue.

Microtips

TECHNOLOGY

MODEL No: MTD0350SZG

TEL: 1-888-499-TIPS (8477)

FAX: (407) 273-0771

E-MAIL: mtusainfo@microtipsusa.com

WEB: www.microtipsusa.com

Record of Revision

Date	Revision No.	Summary
2014-03-18	1.0	Rev 1.0 was issued

1. Scope

This data sheet is to introduce the specification of MTD0350SZG active matrix TFT module. It is composed of a color TFT-LCD panel, driver ICs, FPC and a backlight unit. The 3.5'' display area contains 480XRGB x 640 pixels.

2. Application

Digital equipments which need color display, mobile phone, mobile navigator/video systems.

3. General Information

Item	Contents	Unit
Size	3.5	inch
Resolution	480XRGBx 640	/
Interface	18-bit DBI Type B interface	/
Technology type	α -Si TFT	/
Pixel size	0.1116x0.1116	mm
Pixel Configuration	RGB stripes	
Outline Dimension (W x H x D)	64.00(W \times 85.00(H) \times 3.10(T))	mm
Active Area	53.568(H) \times 71.424 (V)	mm
Display Mode	Transflective/ Normally Black	/
Backlight Type	LED	/
Driver IC	HX8363A	/

5. Interface signals

No.	Symbol	Function
1	DE	Display enable pin from controller
2	GND	Ground
3	GND	Ground
4	GND	Ground
5	NC	Not connected
6~11	R0~R5	DBI TYPE- B interface
12~17	G0~G5	
18~23	B0~B5	
24	SCL	Clock input pin in serial mode
25	SDA	Data pin in serial mode
26	/CS	Chip select signal.
27	DOTCLK	Dot clock signal
28	/RESET	Reset pin
29	HSYNC	Line synchronization signal
30	VSYNC	Frame synchronization signal
31	IOVCC	A power supply for the I/O circuit
32	VCC	A power supply for the analog power
33	GND	Ground
34	LEDA	Power supply for backlight anode input terminals.
35	LEDK	Power supply for backlight cathode input terminals
36	GND	Ground
37	NC	Not connected
38	NC	Not connected
39	NC	Not connected
40	NC	Not connected

6. Absolute maximum Ratings

6.1. Electrical Absolute max. ratings

Item		Symbol	Min.	Max.	Unit	Remark
Supply Voltage	Logic	IOVCCC	-0.3	4.6	V	
	Analog	VCC	-0.3	4.6	V	

6.2. Environment Conditions

Item	Symbol	MIN	MAX	Unit	Remark
Operating Temperature	TOPR	-20	70	°C	
Storage Temperature	TSTG	-30	80	°C	

6.3. LED Backlight Absolute max. ratings

Item	Symbol	MIN	MAX	Unit	Remark
LED Forward Current	I _{LED}	--	25	mA	One LED
LED forward voltage	V _{LED}		3.5	V	

7. Electrical Specifications

7.1 Electrical characteristics

GND=0V, Ta=25°C

Item	Symbol	Min.	Typ.	Max.	Unit	Remark	
Supply Voltage	Logic	IOVCC	1.65	-	3.3	V	
	Analog	VCC	2.3	-	3.3	V	
Logic Low input voltage	VIL	0	-	0.3*IOVCC	V	Digital input pins	
Logic High input voltage	VIH	0.7*IOVCC	-	IOVCC	V	Digital input pins	
Logic Low output voltage	VOL	0	-	0.2*IOVCC	V	IOH=-0.1mA IOVCC=1.65~2.4V	
Logic High output voltage	VOH	0.8*IOVCC	-	IOVCC	V	IOH=-0.1mA	
I/O Leak Current	ILI	-1	-	1	μA		

7.2 LED Backlight

Ta=25°C

Item	Symbol	Min	Typ	Max	Unit	Remark
Forward Voltage	VF	18.0	19.2	21	V	IF=20mA/LED
Forward Current	IF	-	20	-	mA	VF=3.2V/LED
Life time	-	50,000	-	-	Hr	

Backlight circuit:



8. Command/AC Timing

8.1 DBI Type B Interface Timing Characteristics

Write to register or GRAM

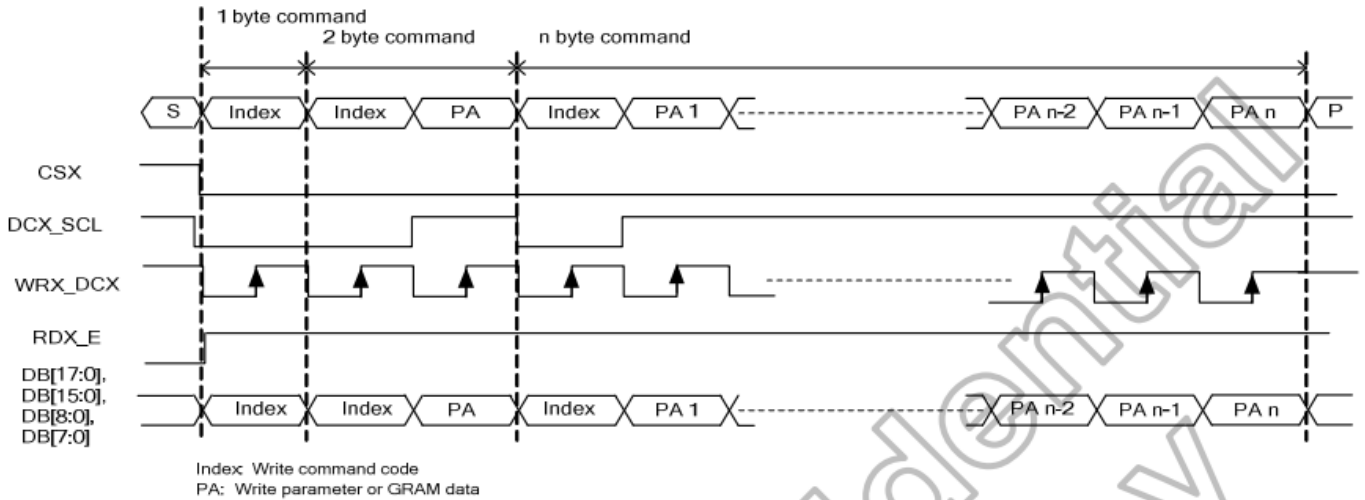

Read to register or GRAM

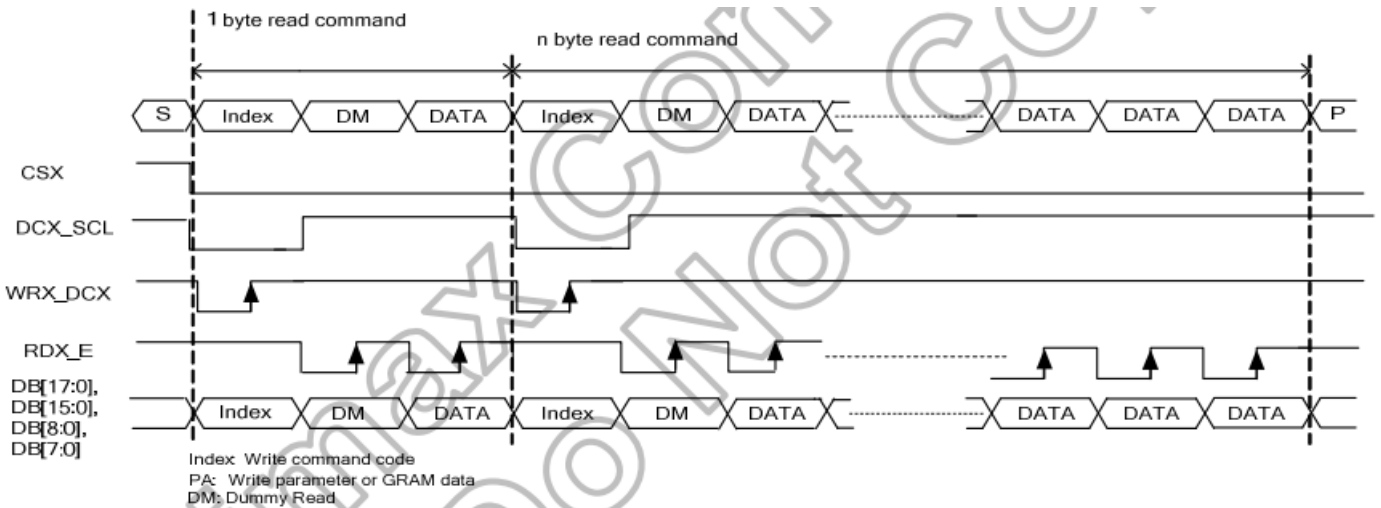

8.2 Reset Timing Characteristics

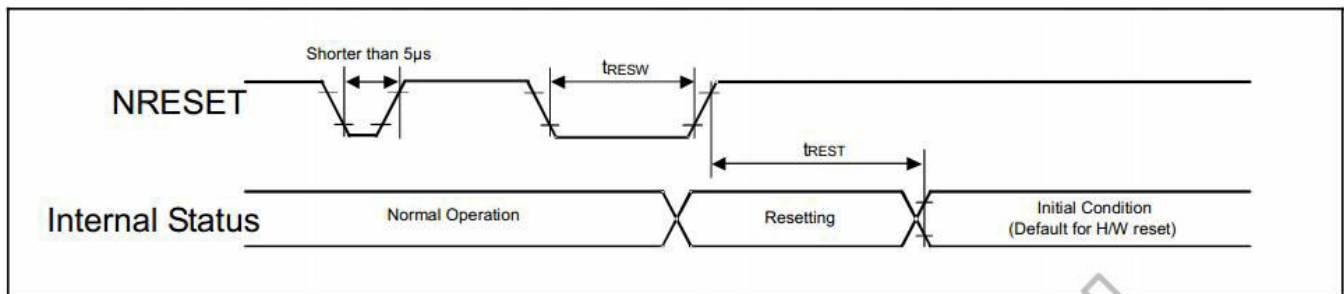

Symbol	Parameter	Related pins	Min.	Typ.	Max.	Note	Unit
t_{RESW}	Reset low pulse width ⁽¹⁾	NRESET	10	-	-	-	μs
t_{REST}	Reset complete time ⁽²⁾	-	5	-	-	When reset is applied during Sleep In mode	ms
		-	120	-	-	When reset is applied during Sleep Out mode	ms

9. Optical Specification

9.1 Transmissive mode

Ta=25°C

Item	Symbol	Condition	Min	Typ.	Max.	Unit	Remark		
Contrast Ratio	CR	$\theta=0^\circ$	300	500	-	-	Note2 Note3		
Response Time	Tr + Tf	25°C	-	30	50	ms	Note2 Note4		
View Angles	θT	$CR \geq 10$	60	80	-	Degree	Note 5		
	θB		60	80	-				
	θL		60	80	-				
	θR		60	80	-				
Chromaticity	White	Brightness is on	x	-	0.312	-	-	Note6, Note2	
			y	-	0.346	-			
	Red		x	Typ-0.02	0.638	Typ+0.02			-
			y		0.330				
	Green		x	0.304	-				
			y	0.575					
	Blue		x	0.155	-				
			y	0.160					
NTSC	S		-	55	-	%	Note6		
Luminance	L		-	120	-	cd/m ²	Note2 Note7		

9.2 Reflective mode (without the backlight)

Item	Symbol	Condition	Min	Typ.	Max.	Unit	Remark
Reflection Ratio (With Polarizer)	R	($\theta = \phi = 0^\circ$)	-	7	-	%	
Reflective Contrast Ratio	CR	$\theta=0^\circ$	-	5	-		
View Angles	θT	$CR \geq 2$	-	45	-	Degree	Note1
	θB		-	45	-		
	θL		-	45	-		
	θR		-	45	-		

Note 1: The polarizers are SRCG31APN2HC5(Top) and SRCH31APT2(Bottom).

Note 2: Definition of optical measurement system.

Temperature = 25°C(±3°C)

LED back-light: ON, Environment brightness < 150 lx

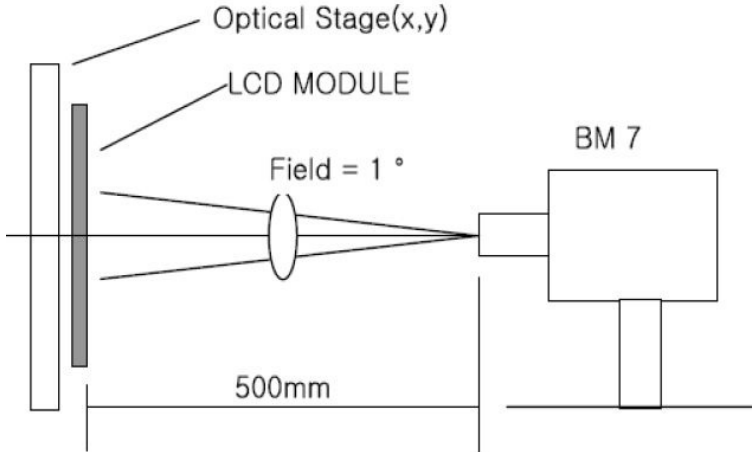

Note 3: Contrast ratio is defined as follow:

$$\text{Contrast Ratio} = \frac{\text{Surface Luminance with all white pixels}}{\text{Surface Luminance with all black pixels}}$$

Note 4: Response time is defined as follow:

Response time is the time required for the display to transition from black to white (Rise Time, Tr) and from white to black (Decay Time, Tf).

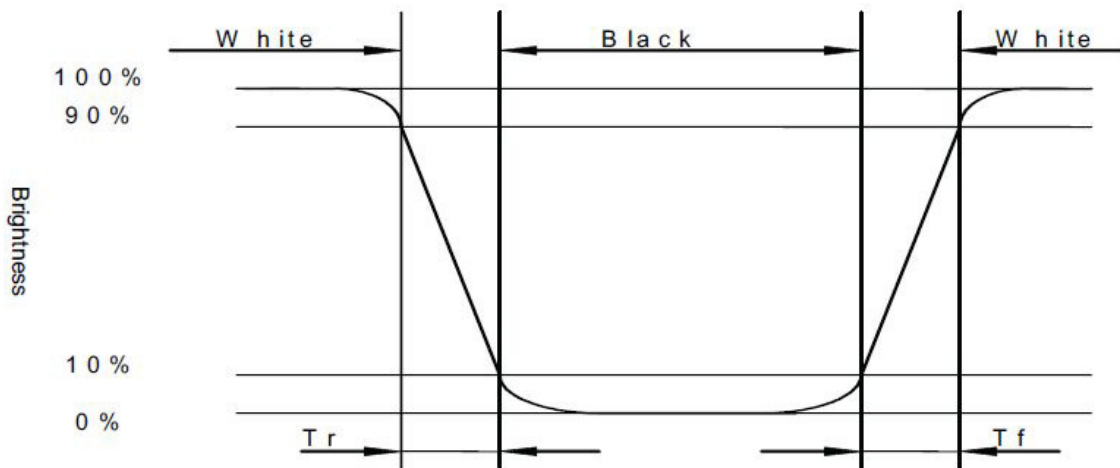

Note 5: Viewing angle range is defined as follow:

Viewing angle is measured at the center point of the LCD.

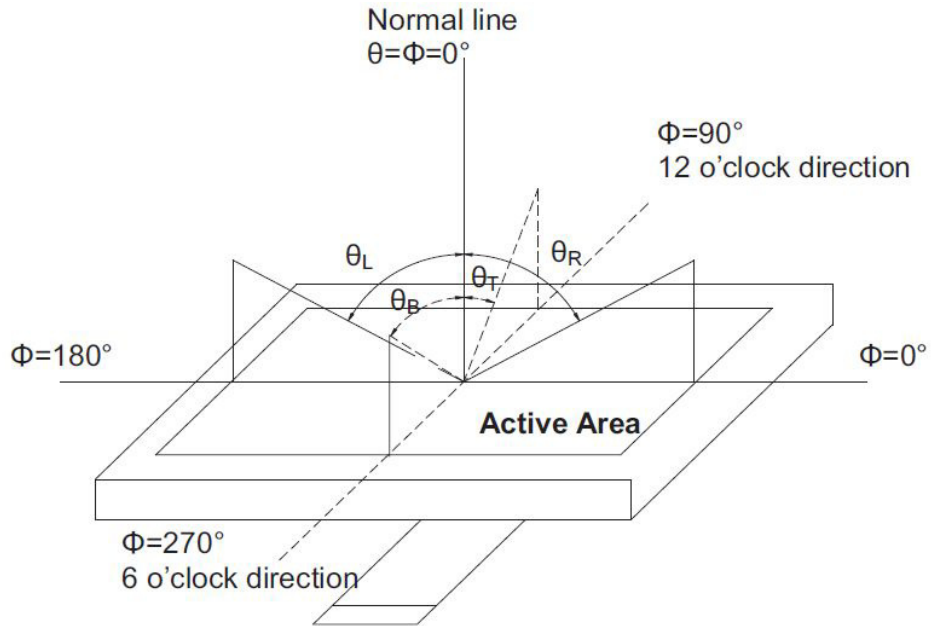

Note 6: Color chromaticity is defined as follow: (CIE1931)

Color coordinates measured at center point of LCD.

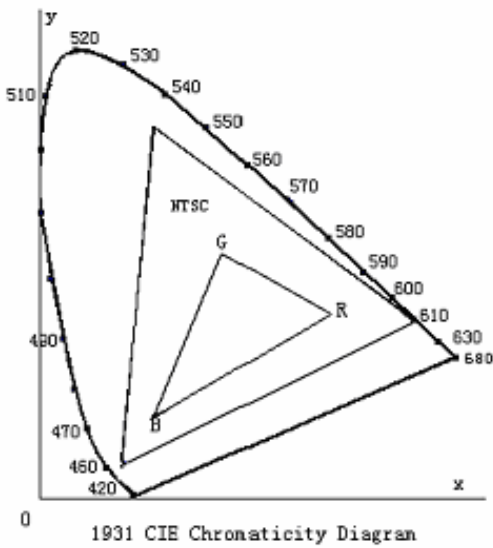

$$S = \frac{\text{area of RGB triangle}}{\text{area of NTSC triangle}} \times 100\%$$

Note 7: Luminance is defined as follow:

Luminance is defined as the brightness of all pixels “White” at the center of display area on optimum contrast.

10. Environmental / Reliability Tests

No	Test Item	Condition	Judgment criteria
1	High Temp Operation	Ts=+70°C, 120hrs	Per table in below
2	Low Temp Operation	Ta=-20°C, 120hrs	Per table in below
3	High Temp Storage	Ta=+80°C, 120hrs	Per table in below
4	Low Temp Storage	Ta=-30°C, 120hrs	Per table in below
5	High Temp & High Humidity Storage	Ta=+60°C, 90% RH 120 hours	Per table in below (polarizer discoloration is excluded)
6	Thermal Shock (Non-operation)	-30°C 30 min~+80°C 30 min, Change time:5min, 100 Cycles	Per table in below
7	ESD (Operation)	Voltage ± 8KV R:330 Ω ,C:150PF, Air Mode,10times	Per table in below
8	Vibration (Non-operation)	Frequency:10Hz~55Hz~10Hz Amplitude:1.5M X,Y,Z direction for total 3hours (Packing Condition)	Per table in below
9	Package Drop Test	Height:100 cm, 1 corner, 3 edges, 6 surfaces	Per table in below

INSPECTION	CRITERION(after test)
Appearance	No Crack on the FPC, on the LCD Panel
Alignment of LCD Panel	No Bubbles in the LCD Panel No other Defects of Alignment in Active area
Electrical current	Within device specifications
Function / Display	No Broken Circuit, No Short Circuit or No Black line No Other Defects of Display

11. Precautions for Use of LCD Modules

11.1 Safety

The liquid crystal in the LCD is poisonous. Do not put it in your mouth. If the liquid crystal touches your skin or clothes, wash it off immediately using soap and water.

11.2 Handling

- A. The LCD and touch panel is made of plate glass. Do not subject the panel to mechanical shock or to excessive force on its surface.
- B. Do not handle the product by holding the flexible pattern portion in order to assure the reliability
- C. Transparency is an important factor for the touch panel. Please wear clear finger sacks, gloves and mask to protect the touch panel from finger print or stain and also hold the portion outside the view area when handling the touch panel.
- D. Provide a space so that the panel does not come into contact with other components.
- E. To protect the product from external force, put a covering lens (acrylic board or similar board) and keep an appropriate gap between them.
- F. Transparent electrodes may be disconnected if the panel is used under environmental conditions where dew condensation occurs.
- G. Property of semiconductor devices may be affected when they are exposed to light, possibly resulting in IC malfunctions.
- H. To prevent such IC malfunctions, your design and mounting layout shall be done in the way that the IC is not exposed to light in actual use.

11.3 Static Electricity

- A. Ground soldering iron tips, tools and testers when they are in operation.
- B. Ground your body when handling the products.
- C. Power on the LCD module before applying the voltage to the input terminals.
- D. Do not apply voltage which exceeds the absolute maximum rating.
- E. Store the products in an anti-electrostatic bag or container.

11.4 Storage

- A. Store the products in a dark place at $+25^{\circ}\text{C} \pm 10^{\circ}\text{C}$ with low humidity (40% RH to 60% RH). Don't expose to sunlight or fluorescent light.
- B. Storage in a clean environment, free from dust, active gas, and solvent.

11.5 Cleaning

- A. Do not wipe the touch panel with dry cloth, as it may cause scratch.
- B. Wipe off the stain on the product by using soft cloth moistened with ethanol. Do not allow ethanol to get in between the upper film and the bottom glass. It may cause peeling issue or defective operation. Do not use any organic solvent or detergent other than ethanol.

11.6 Cautions for installing and assembling

Bezel edge must be positioned in the area between the Active area and View area. The bezel may press the touch screen and cause activation if the edge touches the active area. A gap of approximately 0.5mm is needed between the bezel and the top electrode. It may cause unexpected activation if the gap is too narrow. There is a tolerance of 0.2 to 0.3mm for the outside dimensions of the touch panel and tail. A gap must be made to absorb the tolerance in the case and connector.

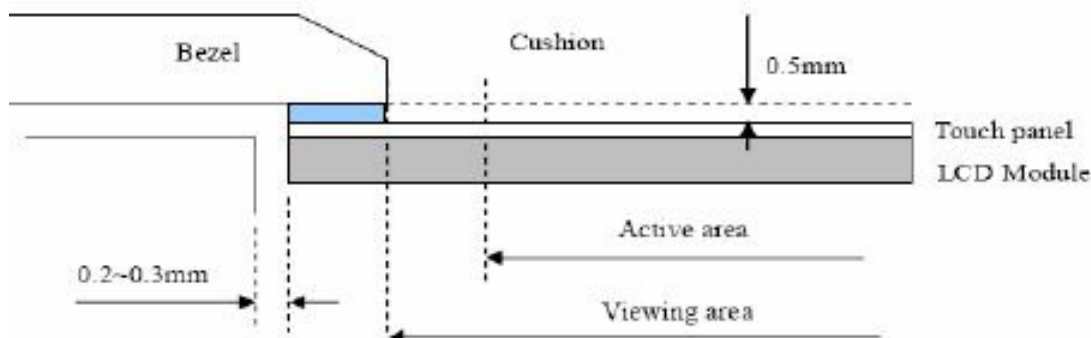

X-ON Electronics

Largest Supplier of Electrical and Electronic Components

Click to view similar products for [TFT Displays & Accessories](#) category:

Click to view products by [Microtips](#) manufacturer:

Other Similar products are found below :

[F3ET2-005-150](#) [HDA430T-3G1H](#) [NB7W-KBA04](#) [NB-ATT01](#) [NB5Q-ATT01](#) [NB5Q-KBA04](#) [NB-CN001](#) [OAI-80038AA-2008-A](#) [315-U004B15300](#) [UMSH-8596MD-34T \(REV D\)](#) [TCG121WXLRXVNNANX35](#) [EIC-LCD-1080P](#) [T-55619GD065J-LW-ABN](#)
[TCG104SVLPEANN-AN30](#) [NL6448BC33-70](#) [NL6448BC20-30D](#) [NL10276BC16-06](#) [NL192108AC10-01D](#) [NL12880BC20-05BD](#)
[NL8060BC26-35BA](#) [NL8060BC31-50F](#) [TM070DDHG03-40](#) [PTPW16-070WV1S02](#) [PTPW17-070WV1S02](#) [PTPW16-084SV1S02](#)
[MTD0300ECP06DF-1](#) [DEM 320240T VMX-PW-N \(A-TOUCH\)](#) [DEM 480128B TMH-PW-N \(A-TOUCH\)](#) [DEM 480272P VMX-PW-N \(C-TOUCH\)](#) [DEM 480272Q VMX-PW-N \(A-TOUCH\)](#) [DEM 480272Q VMX-PW-N \(C-TOUCH\)](#) [DEM 640480E TMH-PW-N \(A-TOUCH\)](#)
[DEM 800480K1 TMH-PW-N \(A-TOUCH\)](#) [DEM 800480K1 TMH-PW-N \(C-TOUCH\)](#) [DEM 800480K2 TMH-PW-N \(A-TOUCH\)](#) [DEM 800480K3 TMH-PW-N \(C-TOUCH\)](#) [DEM 800480K4 TMH-PW-N \(A-TOUCH\)](#) [DEM 800480K4 TMH-PW-N \(C-TOUCH\)](#) [4DLCD-35480320-CTP-IPS](#) [4DLCD-35480320-IPS](#) [4DLCD-35480320-RTP-IPS](#) [4DLCD-50800480-CTP-IPS](#) [RFA6400E-AWH-DNG](#) [RFA6400E-AWH-MNN](#) [RFE430V-AZW-DNS](#) [RFF70VA2-1IW-DHS](#) [RFH700A8-AYH-MNN](#) [RFK101VF-1YH-LHG](#) [RFS390C-AIW-DNN](#) [RFS390C-AIW-DNS](#)