

The logo consists of three vertical bars of varying heights and colors: red, green, and blue, each with diagonal lines.

Microtips

TECHNOLOGY

Model No: MTÖ€I H€ÒZÕË/ËG

TEL: 1-888-499-TIPS (8477)

FAX: (407) 273-0771

E-MAIL: mtusainfo@microtipsusa.com

WEB: www.microtipsusa.com

Record of Revision

Date	Revision No.	Summary
2011-05-26	1.0	Rev 1.0 was issued
2015-04-21	1.1	Adding LED lifetime
2017-04-20	2.0	Change TFT panel

1. Scope

This data sheet is to introduce the specification of AH8 \$(' \$9N; !H!& active matrix TFT module. It is composed of a color TFT-LCD panel, driver ICs, FPC, Touch panel and a backlight unit. The 4.3" display area contains 480(RGB) x 272 pixels.

2. Application

Digital equipments which need color display, mobile navigator/video systems.

3. General Information

Item	Contents	Unit
Size	4.3	inch
Resolution	480 (RGB) x 272	/
Interface	RGB	/
Technology type	a-Si TFT	/
Pixel pitch	0.198x0.198	mm
Pixel Configuration	RGB stripes	
Outline Dimension (W x H x D)	105.50x67.20x4.10	mm
Active Area	95.04 x 53.856	mm
Display Mode	Transmissive Normally white	/
Backlight Type	LED	/
Driver IC	HX8257A	/

("''Ci h]bY'8 fUk]b[

PIN	FUNCTION	PIN SYMBOL
1	VLED-	VLED-
2	VLED+	VLED+
3	GND	GND
4	VDD	VDD
5	R0	R0
6	R1	R1
7	R2	R2
8	R3	R3
9	R4	R4
10	R5	R5
11	R6	R6
12	R7	R7
13	G0	G0
14	G1	G1
15	G2	G2
16	G3	G3
17	G4	G4
18	G5	G5
19	G6	G6
20	G7	G7
21	R0	R0
22	B1	B1
23	B2	B2
24	B3	B3
25	B4	B4
26	B5	B5
27	B6	B6
28	B7	B7
29	GND	GND
30	PCLK	PCLK
31	DISP	DISP
32	HSYNC	HSYNC
33	VSYNC	VSYNC
34	IE	IE
35	NC	NC
36	GND	GND
37	X1	X1
38	Y1	Y1
39	X2	X2
40	Y2	Y2

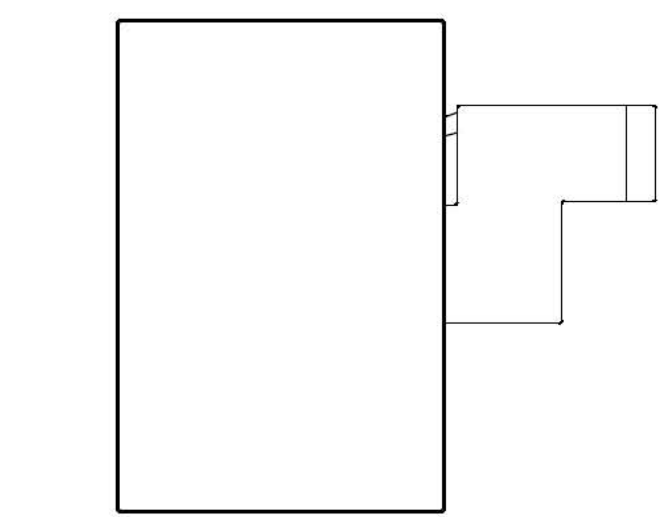

1. LED CIRCUIT DIAGRAM:

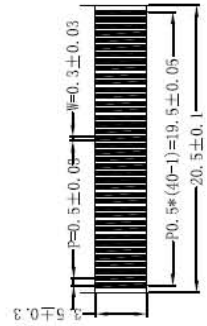
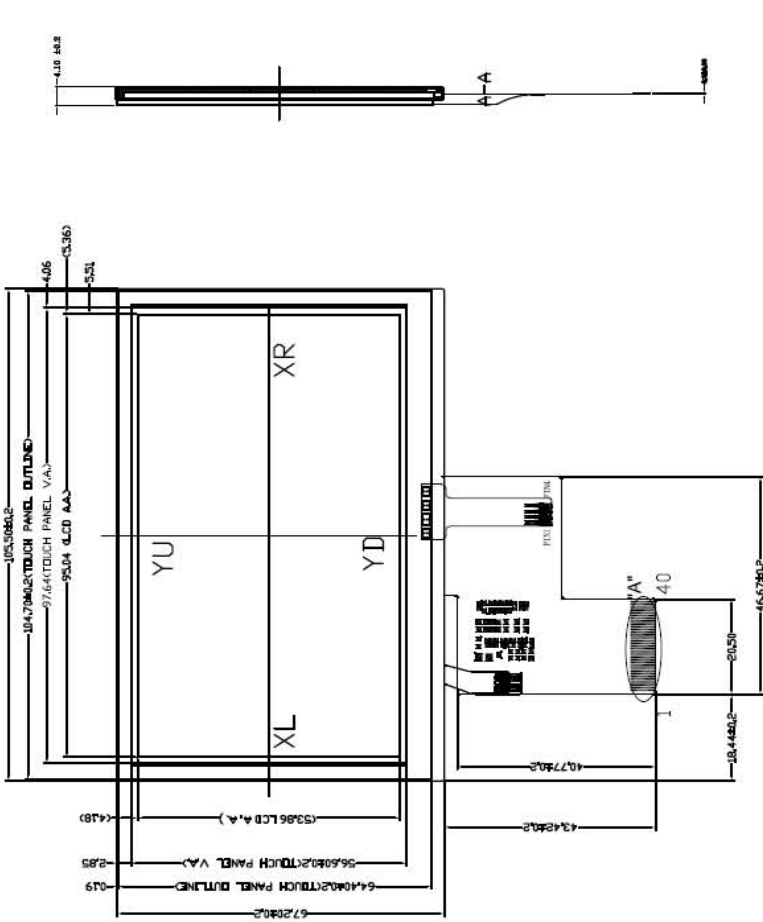
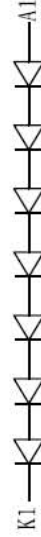

DETAIL "A" (S=3:1)

NOTES:

- 1.DISPLAY TYPE: a-Si TFT
- 2.DISPLAY MODULE: Transmissive ,Normally White
- 3.OPERATIN TEMP: -20° C--+70° C
- 4.STORAGE TEMP: -30° C--+80° C
- 5.Backlight: LED
6. RoHS Complicant



DRAWN BY:	BY:	TITLE: A H8\$(' \$9N; IH&	SCALE:	mm
CHECKED BY:	BY:	DWG NO:	UNIT:	mm
APPROVED BY:	BY:	DWG NAME:	SHEET NO:	OF

5. Interface signals

Pin No	Symbol	Function
1	VLED-	BACK LIGHT POWER GROUND
2	VLED+	BACK LIGHT POWER SUPPLY
3	GND	POWER GROUND
4	VDD	POWER SUPPLY
5-12	R0-R7	RED DATA
13-20	G0-G7	GREEN DATA
21-28	B0-B7	BLUE DATA
29	GND	POWER GROUND
30	PCLK	In external interface mode, served as a dot clock signal.
31	DISP	standby mode control pin
32	HSYNC	In external interface mode, served as a horizontal synchronized signal input
33	VSYNC	In external interface mode, served as a vertical synchronize signal input
34	DE	In external interface mode, polarity of ENABLE signal is synchronized with valid graphic data input.
35	NC	NC
36	GND	POWER GROUND
37	X1	TOUCH PANEL CONTROL PIN
38	Y1	
39	X2	
40	Y2	

The recommended connector: FH19SC-40S-0.5SH (HIROSE.)

6. Absolute maximum Ratings

6.1. Electrical Absolute max. ratings

Parameter	Symbol	MIN	MAX	Unit	Remark
Logic Supply Voltage	VDD	-0.3	5.0	V	
Input Voltage	VIN	-0.3	VDD +0.3	V	

6.2. Environment Conditions

Item	Symbol	MIN	MAX	Unit	Remark
Operating Temperature	TOPR	-20	70	°C	
Storage Temperature	TSTG	-30	80	°C	

6.3. LED Backlight Absolute max. ratings

Item	Symbol	MIN	MAX	Unit	Remark
LED Forward Current	ILED	--	25	mA	each LED

7. Electrical Specifications

7.1 Electrical characteristics

Ta = 25 °C, GND=0V

Item	Symbol	MIN	TYP	MAX	Unit	Remark
Supply Voltage	VDD	3.0	3.3	3.6	V	
Input Signal Voltage	VIL	0	--	0.3*VDD	V	
	VIH	0.7*VDD	--	VDD	V	
Output Signal Voltage	VOL	--	--	0.3* VDD	V	
	VOH	0.7*VDD	--	VDD	V	

7.2 LED Backlight

Ta=25°C

Item	Symbol	MIN	TYP	MAX	Unit	Remark
Forward Current	IF	--	20	--	mA	One LED
Forward Voltage	VF	--	22.4	--	V	If=20mA
LED lifetime	--	--	25,000	--	Hr	Note



CIRCUIT DIAGRAM

Note : The "LED life time" is defined as the module brightness decrease to 50% of original brightness at Ta=25°C and IBL =20mA. The LED lifetime will be decreased if operating IBL is larger than 20mA.

7.3 Schematic of LCD module system

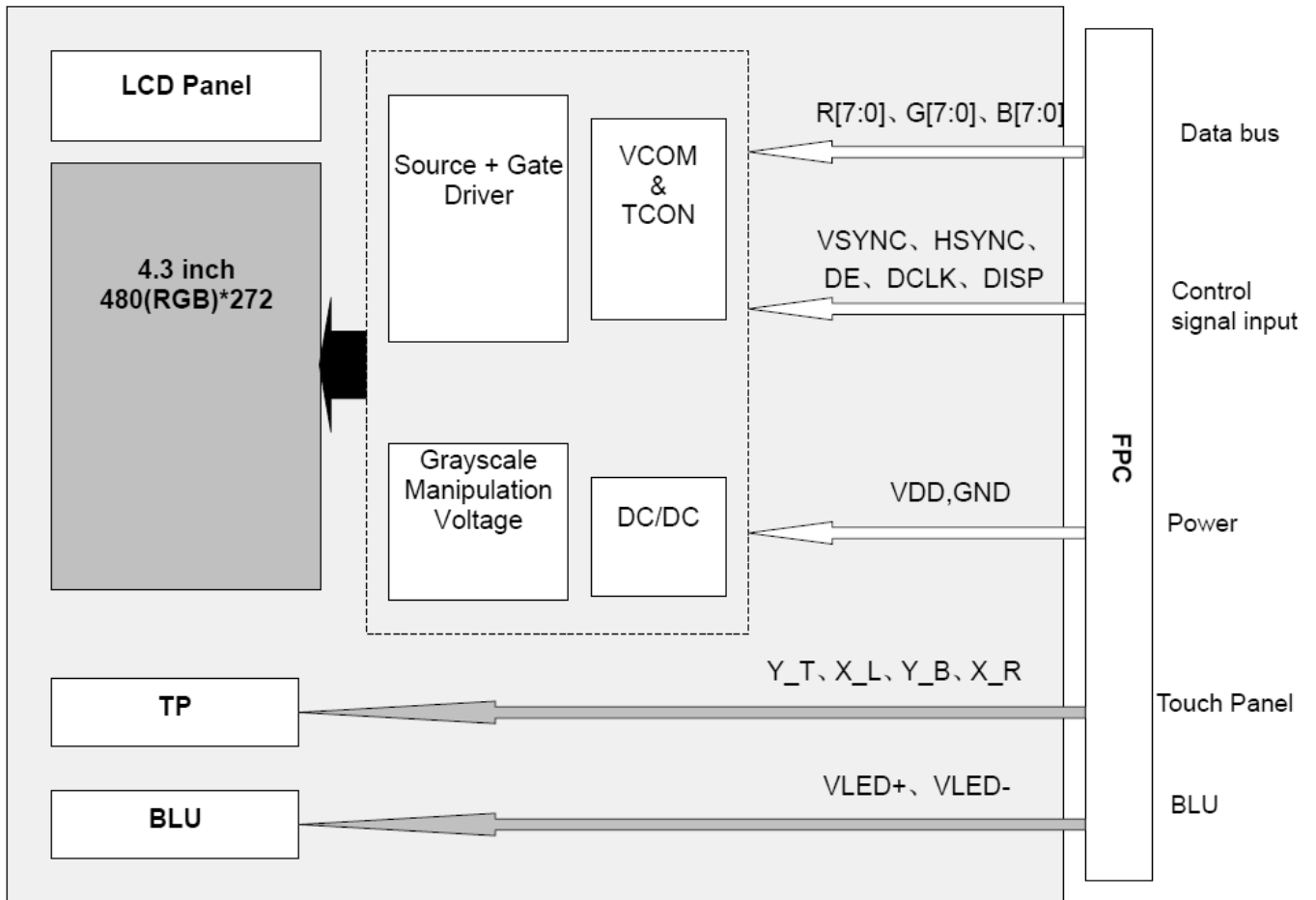

8. Command/AC Timing

8.1 Timing relationship among DE, Source Output, Gate Output, VCOM

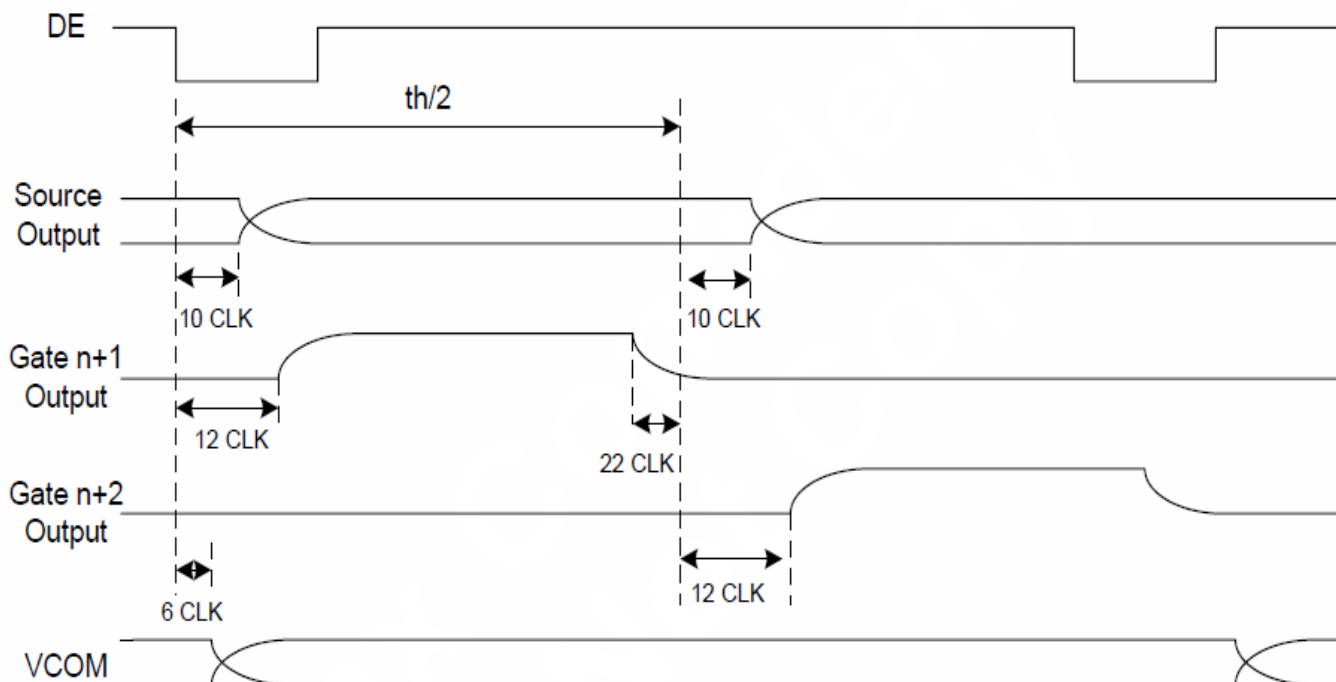

8.2 Parallel RGB input timing requirement

(480RGB×272, TA=25°C, VDDIO=1.8V to 3.6V, DVSS=0V)

Parameter	Symbol	Spec.			Unit
		Min	Typ	Max	
Clock cycle	fCLK(1)	-	9	15	MHz
Hsync cycle	1/th	-	17.14	-	KHz
Vsync cycle	1/tv	-	59.94	-	Hz
Horizontal Signal					
Horizontal cycle	th	525	525	605	CLK
Horizontal display period	thd	480	480	480	CLK
Horizontal front porch	thf	2	2	82	CLK
Horizontal pulse width	thp(2)	2	41	41	CLK
Horizontal back porch	thb(2)	2	2	41	CLK
Vertical Signal					
Vertical cycle	tv	285	286	399	H(1)
Vertical display period	tvd	272	272	272	H(1)
Vertical front porch	tvf	1	2	227	H(1)
Vertical pulse width	tvp(2)	1	10	11	H(1)
Vertical back porch	tvb(2)	1	2	11	H(1)

Note: (1) Unit: CLK=1/fCLK, H=th,

(2) It is necessary to keep tvp+ thb=43 in sync mode. DE mode is unnecessary to keep it.

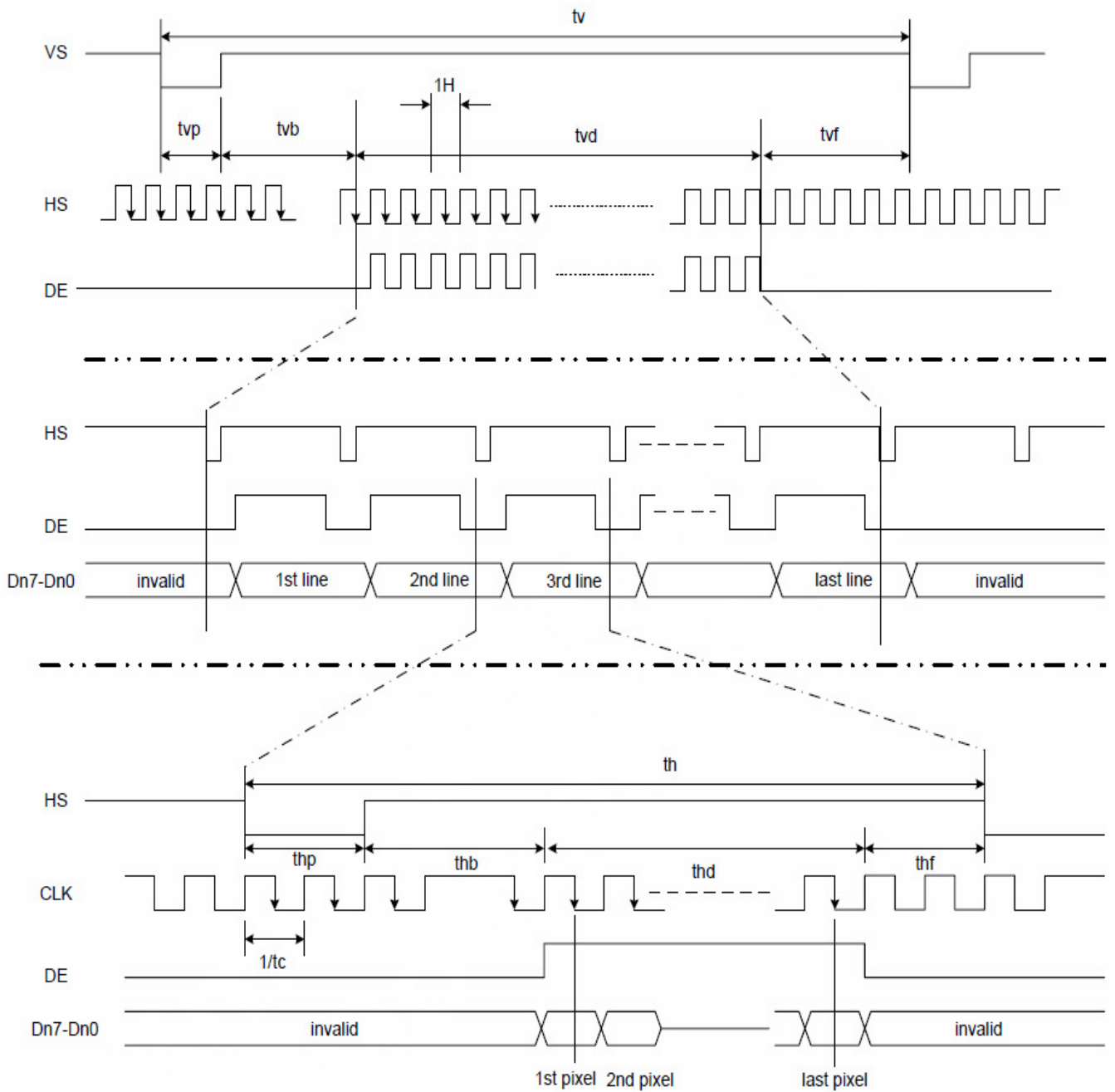

8.3 Serial RGB input timing requirement

(480RGB×272, TA=25°C, VDDIO=1.8V to 3.6V, DVSS=0V)

Parameter	Symbol	Spec.			Unit
		Min	Typ	Max	
Clock cycle	fCLK(1)	-	27	33	MHz
Hsync cycle	1/th	-	17.14	-	KHz
Vsync cycle	1/tv	-	59.94	-	Hz
Horizontal Signal					
Horizontal cycle	th	1575	1575	1815	CLK
Horizontal display period	thd	1440	1440	1440	CLK
Horizontal front porch	thf	6	6	246	CLK
Horizontal pulse width	thp	6	123	123	CLK
Horizontal back porch	thb	6	6	123	CLK
Vertical Signal					
Vertical cycle	tv	285	286	399	H(1)
Vertical display period	tvd	272	272	272	H(1)
Vertical front porch	tvf	1	2	227	H(1)
Vertical pulse width	tvp	1	10	11	H(1)
Vertical back porch	tvb	1	2	11	H(1)

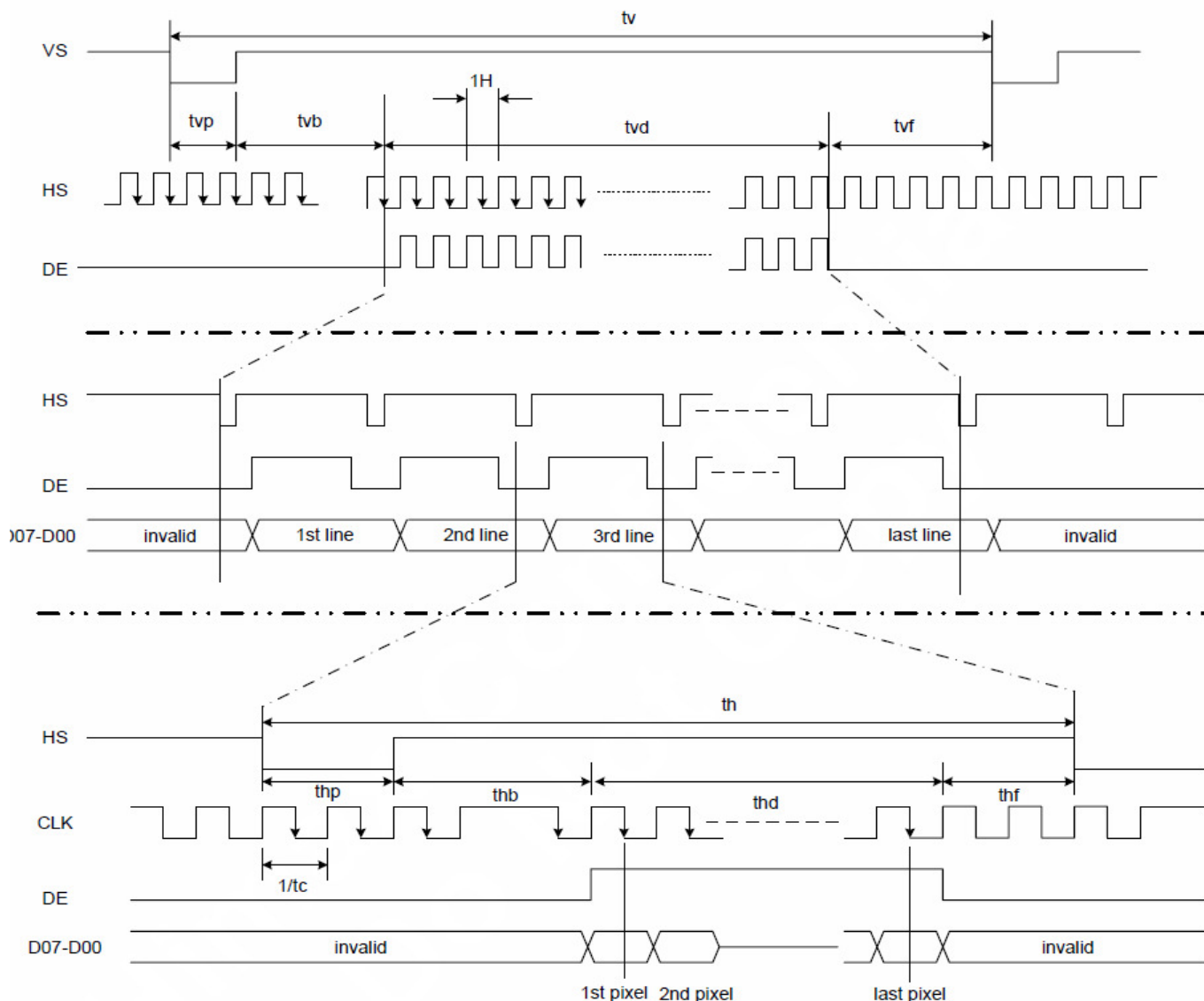

8.4 Input setup timing requirement

(TA=25°C, VDDIO=1.8V to 3.6V, DVSS=0V, tr(1)=tf(1)=2ns)

Parameter	Symbol	Spec.			Unit
		Min	Typ	Max	
DISP setup time	tdiss	10	-	-	ns
DISP hold time	tdish	10	-	-	ns
Clock period	PWCLK(2)	66.7	-	-	ns
Clock pulse high period	PWH(2)	26.7	-	-	ns
Clock pulse low period	PWL(2)	26.7	-	-	ns
Hsync setup time	ths	10	-	-	ns
Hsync hold time	thh	10	-	-	ns
Data setup time	tds	10	-	-	ns
Data hold time	tdh	10	-	-	ns
DE setup time	tdes	10	-	-	ns
DE hold time	tdeh	10	-	-	ns
Vsync setup time	tvhs	10	-	-	ns
Vsync hold time	tvhh	10	-	-	ns

Note: (1) tr, tf is defined 10% to 90% of signal amplitude.

(2) For parallel interface, maximum clock frequency is 15MHz.

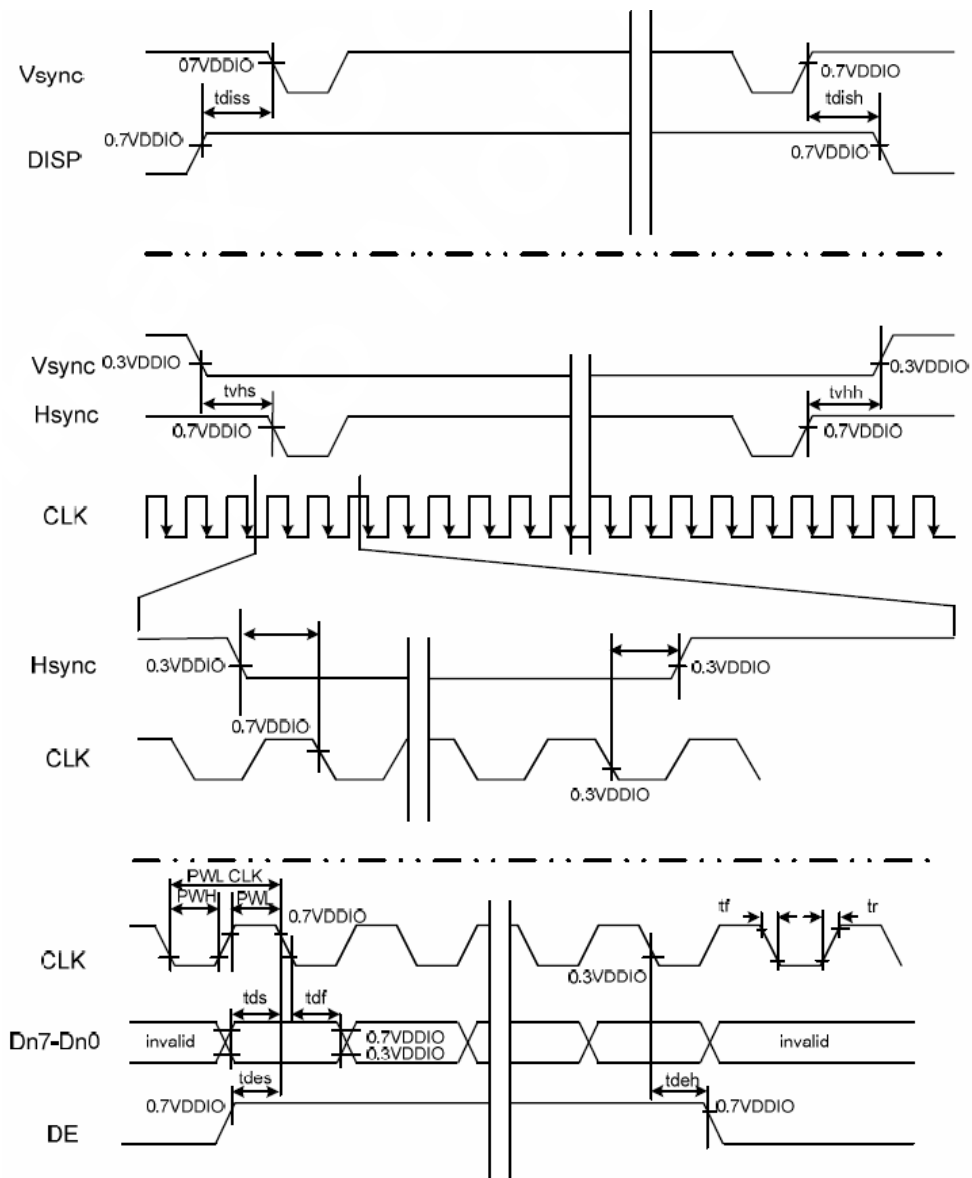

9. Optical Specification

Ta=25°C

Item	Symbol	Condition	Min	Typ.	Max.	Unit	Remark
Contrast Ratio	CR	$\theta=0^\circ$	350	500	-		Note1 Note2
Response Time	Ton/ Toff	25°C	-	20	-	ms	Note1 Note3
View Angles	θT	$CR \geq 10$	60	70	-	Degree	Note 4
	θB		40	50	-		
	θL		60	70	-		
	θR		60	70	-		
Chromaticity	White	Brightness is on	x	0.294	0.314	0.334	Note5, Note1
			y	0.324	0.344	0.364	
	Red		x	0.631	0.651	0.671	
			y	0.311	0.331	0.351	
	Green		x	0.296	0.316	0.336	
			y	0.553	0.573	0.593	
	Blue		x	0.118	0.138	0.158	
			y	0.111	0.131	0.151	
NTSC	S			51		%	Note5
Luminance	L		200	220	-	cd/m ²	Note1 Note6
Uniformity	U		75	80	-	%	Note1 Note7

Note 1: Definition of optical measurement system.

Temperature = 25°C(±3°C)

LED back-light: ON, Environment brightness < 150 lx

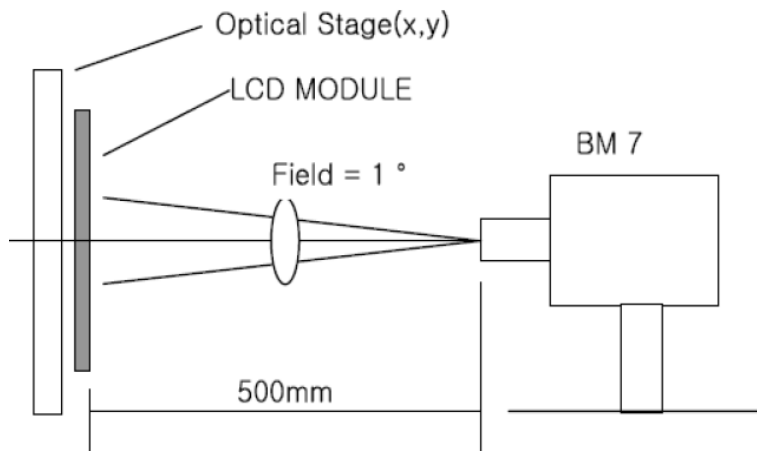

Note 2: Contrast ratio is defined as follow:

$$\text{Contrast Ratio} = \frac{\text{Surface Luminance with all white pixels}}{\text{Surface Luminance with all black pixels}}$$

Note 3: Response time is defined as follow:

Response time is the time required for the display to transition from black to white (Rise Time, T_r) and from white to black(Decay Time, T_f).

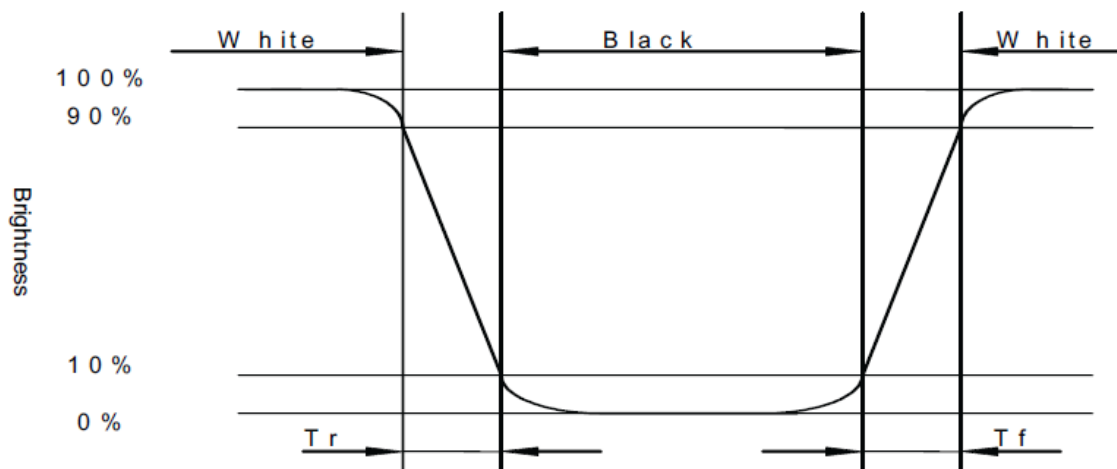

Note 4: Viewing angle range is defined as follow:

Viewing angle is measured at the center point of the LCD.

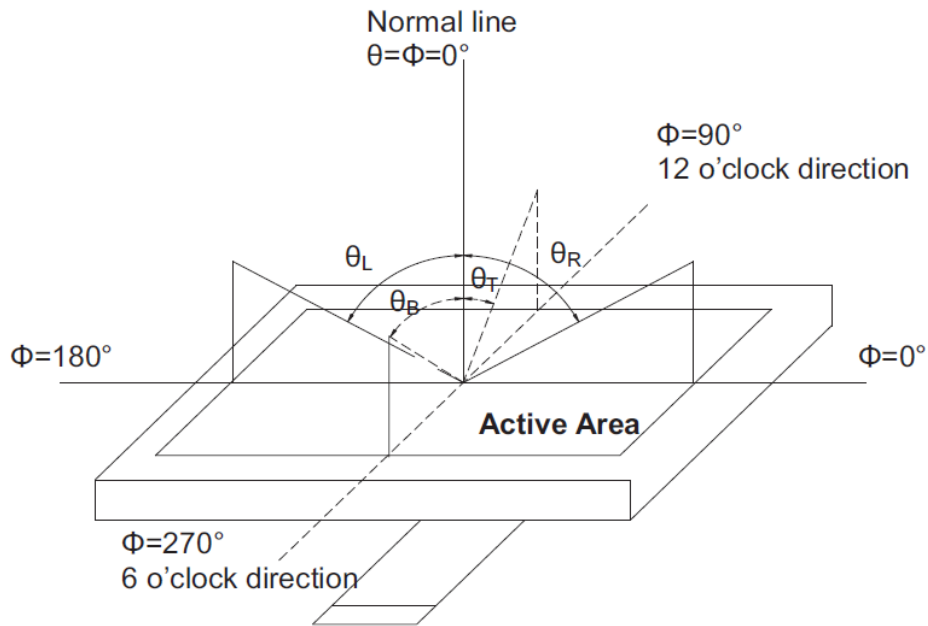

Note 5: Color chromaticity is defined as follow: (CIE1931)

Color coordinates measured at center point of LCD.

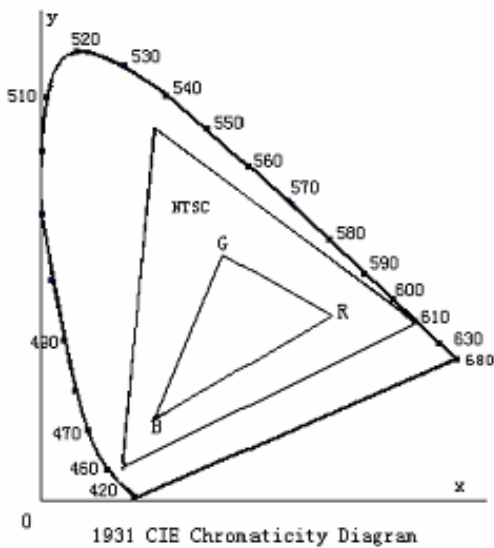

$$S = \frac{\text{area of RGB triangle}}{\text{area of NTSC triangle}} \times 100\%$$

Note 6: Luminance is defined as follow:

Luminance is defined as the brightness of all pixels “White” at the center of display area on optimum contrast.

Note 7: Luminance Uniformity is defined as follow:

Active area is divided into 9 measuring areas (Refer Fig. 2). Every measuring point is placed at the center of each measuring area.

$$\text{Uniformity}(U) = \frac{\text{Minimum Luminance(brightness) in 9 points}}{\text{Maximum Luminance(brightness) in 9 points}}$$

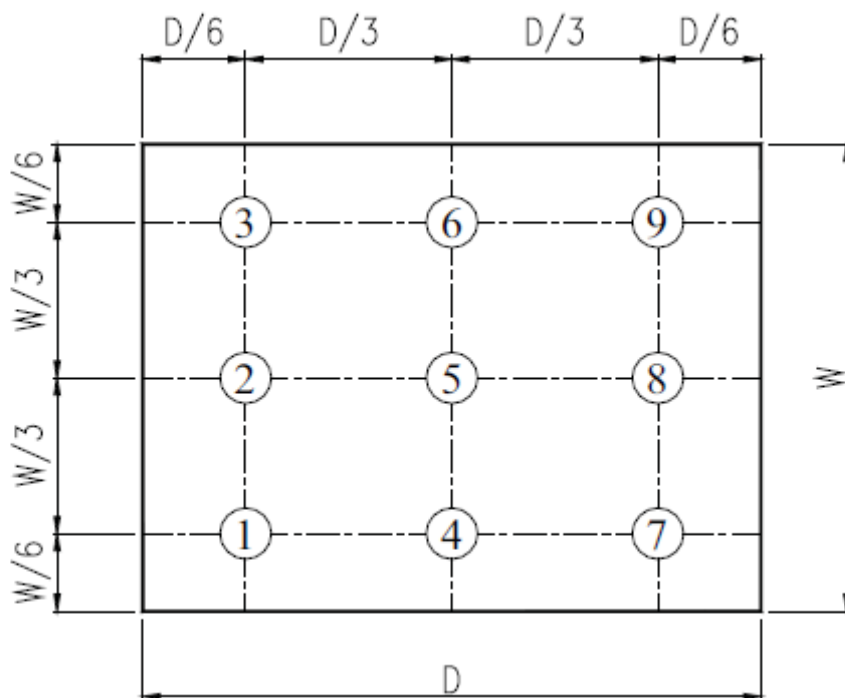

Fig. 2 Definition of uniformity

10. Environmental / Reliability Tests

No	Test Item	Condition	Judgment criteria
1	High Temp Operation	Ts=+70°C, 120hrs	Per table in below
2	Low Temp Operation	Ta=-20°C, 120hrs	Per table in below
3	High Temp Storage	Ta=+80°C, 120hrs	Per table in below
4	Low Temp Storage	Ta=-30°C, 120hrs	Per table in below
5	High Temp & High Humidity Storage	Ta=+50°C, 90% RH 120 hours	Per table in below (polarizer discoloration is excluded)
6	Thermal Shock (Non-operation)	-30°C 30 min~+80°C 30 min, Change time:5min, 10 Cycles	Per table in below
7	ESD (Operation)	C=150pF, R=330Ω , 5points/panel Air:±8KV, 5times; Contact:±4KV, 5 times;	Per table in below
8	Vibration (Non-operation)	Frequency range:10~55Hz, Stroke:1.5mm Sweep:10Hz~55Hz~10Hz 2 hours for each direction of X.Y.Z.	Per table in below
9	Shock (Non-operation)	60G 6ms, ±X,±Y,±Z 3times, for each direction	Per table in below
10	Package Drop Test	Height:80 cm, 1 corner, 3 edges, 6 surfaces	Per table in below

INSPECTION	CRITERION(after test)
Appearance	No Crack on the FPC, on the LCD Panel
Alignment of LCD Panel	No Bubbles in the LCD Panel No other Defects of Alignment in Active area
Electrical current	Within device specifications
Function / Display	No Broken Circuit, No Short Circuit or No Black line No Other Defects of Display

11. Precautions for Use of LCD Modules

11.1 Safety

The liquid crystal in the LCD is poisonous. Do not put it in your mouth. If the liquid crystal touches your skin or clothes, wash it off immediately using soap and water.

11.2 Handling

A. The LCD and touch panel is made of plate glass. Do not subject the panel to mechanical shock or to excessive force on its surface.

B. Do not handle the product by holding the flexible pattern portion in order to assure the reliability

C. Transparency is an important factor for the touch panel. Please wear clear finger sacks, gloves and mask to protect the touch panel from finger print or stain and also hold the portion outside the view area when handling the touch panel.

D. Provide a space so that the panel does not come into contact with other components.

E. To protect the product from external force, put a covering lens (acrylic board or similar board) and keep an appropriate gap between them.

F. Transparent electrodes may be disconnected if the panel is used under environmental conditions where dew condensation occurs.

G. Property of semiconductor devices may be affected when they are exposed to light, possibly resulting in IC malfunctions.

H. To prevent such IC malfunctions, your design and mounting layout shall be done in the way that the IC is not exposed to light in actual use.

11.3 Static Electricity

A. Ground soldering iron tips, tools and testers when they are in operation.

B. Ground your body when handling the products.

C. Power on the LCD module before applying the voltage to the input terminals.

D. Do not apply voltage which exceeds the absolute maximum rating.

E. Store the products in an anti-electrostatic bag or container.

F. Peel off the LCM protective film slowly since static electricity may be generated.

11.4 Storage

A. Store the products in a dark place at $+25^{\circ}\text{C} \pm 10^{\circ}\text{C}$ with low humidity (40% RH to 60% RH). Don't expose to sunlight or fluorescent light.

B. Storage in a clean environment, free from dust, active gas, and solvent.

11.5 Cleaning

A. Do not wipe the touch panel with dry cloth, as it may cause scratch.

B. Wipe off the stain on the product by using soft cloth moistened with ethanol. Do not allow ethanol to get in between the upper film and the bottom glass. It may cause peeling issue or defective operation. Do not use any organic solvent or detergent other than ethanol.

11.6 Cautions for installing and assembling

Bezel edge must be positioned in the area between the Active area and View area. The bezel may press the touch screen and cause activation if the edge touches the active area. A gap of approximately 0.5mm is needed between the bezel and the top electrode. It may cause unexpected activation if the gap is too narrow. There is a tolerance of 0.2 to 0.3mm for the outside dimensions of the touch panel and tail. A gap must be made to absorb the tolerance in the case and connector.

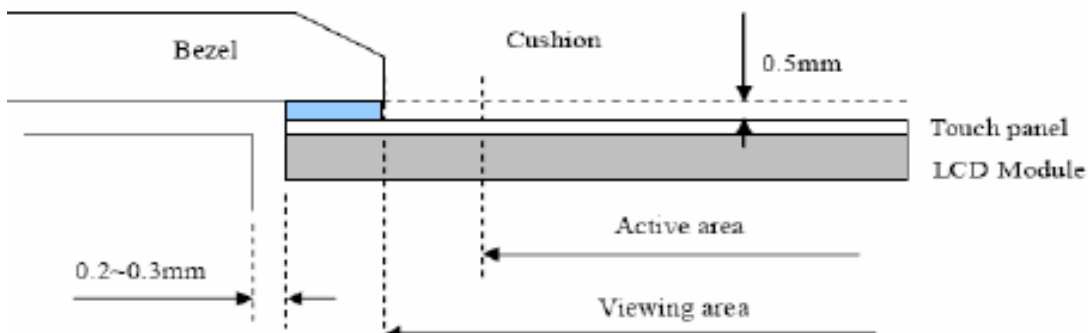

X-ON Electronics

Largest Supplier of Electrical and Electronic Components

Click to view similar products for [TFT Displays & Accessories category](#):

Click to view products by [Microtips manufacturer](#):

Other Similar products are found below :

[F3ET2-005-150](#) [HDA430T-3G1H](#) [NL6448BC20-21D](#) [NB7W-KBA04](#) [NB-ATT01](#) [NB5Q-ATT01](#) [NB5Q-KBA04](#) [NB-CN001](#) [OAI-80038AA-2008-A](#) [315-U004B15300](#) [UMSH-8596MD-34T \(REV D\)](#) [TCG121WXLRXVNNANX35](#) [EIC-LCD-1080P](#) [T-55619GD065J-LW-ABN](#) [TCG104SVLPEANN-AN30](#) [NL6448BC33-70](#) [NL6448BC20-30D](#) [NL10276BC16-06](#) [NL192108AC10-01D](#) [NL12880BC20-05BD](#) [NL8060BC26-35BA](#) [NL8060BC31-50F](#) [TM070DDHG03-40](#) [NL10276AC30-42C](#) [PTPW16-070WV1S02](#) [PTPW17-070WV1S02](#) [PTPW16-084SV1S02](#) [MTD0300ECP06DF-1](#) [DEM 320240T VMX-PW-N \(A-TOUCH\)](#) [DEM 480128B TMH-PW-N \(A-TOUCH\)](#) [DEM 480272P VMX-PW-N \(C-TOUCH\)](#) [DEM 480272Q VMX-PW-N \(A-TOUCH\)](#) [DEM 480272Q VMX-PW-N \(C-TOUCH\)](#) [DEM 640480E TMH-PW-N \(A-TOUCH\)](#) [DEM 800480K1 TMH-PW-N \(A-TOUCH\)](#) [DEM 800480K1 TMH-PW-N \(C-TOUCH\)](#) [DEM 800480K2 TMH-PW-N \(A-TOUCH\)](#) [DEM 800480K3 TMH-PW-N \(C-TOUCH\)](#) [DEM 800480K4 TMH-PW-N \(A-TOUCH\)](#) [DEM 800480K4 TMH-PW-N \(C-TOUCH\)](#) [4DLCD-35480320-CTP-IPS](#) [4DLCD-35480320-IPS](#) [4DLCD-35480320-RTP-IPS](#) [4DLCD-50800480-CTP-IPS](#) [RFA6400E-AWH-DNG](#) [RFA6400E-AWH-MNN](#) [RFE430V-AZW-DNS](#) [RFF70VA2-1IW-DHS](#) [RFH700A8-AYH-MNN](#) [RFK101VF-1YH-LHG](#)