

The logo features three vertical bars of varying heights and colors: red, green, and blue, each with diagonal lines.

Microtips

TECHNOLOGY

Model No: MTÖ€ HEVÖÜ

TEL: 1-888-499-TIPS (8477)

FAX: (407) 273-0771

E-MAIL: mtusainfo@microtipsusa.com

WEB:www.microtipsusa.com

Record of Revision

Date	Revision No.	Summary
2017-03-28	1.0	Rev 1.0 was issued

1. Scope

This data sheet is to introduce the specification of **MTD0430TGR** active matrix TFT module. It is composed of a color TFT-LCD panel, driver ICs, FPC and a backlight unit. The 4.3” display area contains 480 (RGB) x 272 pixels.

2. Application

Digital equipments which need color display, mobile navigator/video systems.

3. General Information

Item	Contents	Unit
Size	4.3	inch
Resolution	480 (RGB) x 272	/
Interface	RGB-24bit	/
Technology type	a-Si TFT	/
Pixel pitch	0.198x0.198	mm
Pixel Configuration	R.G.B. Vertical Stripe	
Outline Dimension (W x H x D)	105.5 x 67.2 x 2.95	mm
Active Area	95.04 x 53.86	mm
Display Mode	Transmissive Normally White	/
Backlight Type	LED	/

4. Outline Drawing

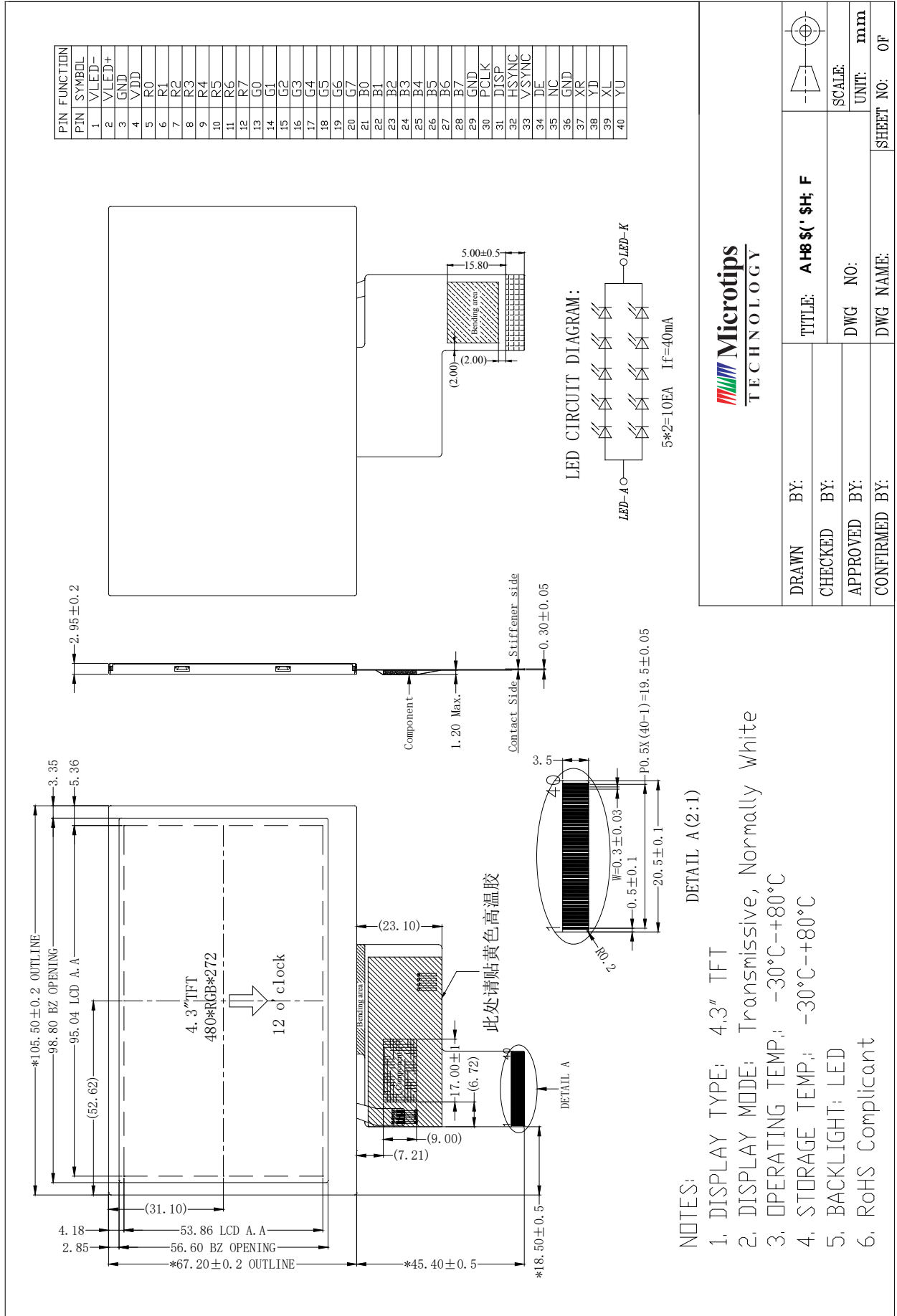

5. Interface signals

No.	Symbol	Description
1	VLED-	Backlight LED Cathode
2	VLED+	Backlight LED Anode.
3	GND	System Ground
4	VDD	Power supply
5~12	R0~R7	Data bus
13~20	G0~G7	Data bus
21~28	B0~B7	Data bus
29	GND	System Ground
30	PCLK	Pixel clock signal
31	DISP	Display on/off control
32	HSYNC	Horizontal Sync signal
33	VSYNC	Vertical Sync signal
34	DE	Data Enable
35	NC	No connect
36	GND	System Ground
37	XR(NC)	No connect
38	YD(NC)	No connect
39	XL(NC)	No connect
40	YU(NC)	No connect

The recommended connector: FH19SC-40S-0.5SH manufactured by HIROSE.

6. Absolute maximum Ratings

6.1. Electrical Absolute max. ratings

Parameter	Symbol	MIN	MAX	Unit	Remark
Supply Voltage	VDD	-0.3	4.0	V	

6.2. Environment Conditions

Item	Symbol	MIN	MAX	Unit	Remark
Operating Temperature	TOPR	-30	80	°C	
Storage Temperature	TSTG	-30	80	°C	

6.3. LED Backlight Absolute max. ratings

Item	Symbol	MIN	MAX	Unit	Remark
LED Forward Current	ILED	--	25	mA	One LED

7. Electrical Specifications

7.1 Electrical characteristics

GND=0V, Ta=25°C

Item	Symbol	MIN	TYP	MAX	Unit	Remark
Supply Voltage	VDD	3.0	3.3	3.6	V	
Input Signal Voltage	VIL	--	--	0.3xVDD	V	
	VIH	0.7xVDD	--	VDD	V	
Output Signal Voltage	VOL	--	--	0.2xVDD	V	
	VOH	0.8xVDD	--	VDD	V	

7.2 LED Backlight

Ta=25°C

Item	Symbol	MIN	TYP	MAX	Unit	Remark
Forward Current	IBL	-	40	50	mA	Note 1
Forward Voltage	VBL	15	16	-	V	
LED lifetime	-	-	25000	-	Hrs	Note 2

Note 1: Each LED: IF =20 mA, VF = 3.2V.

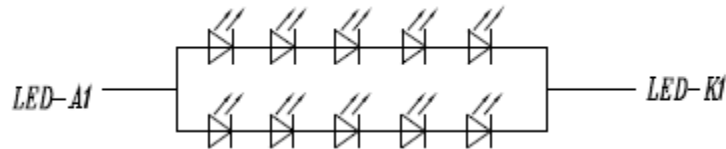
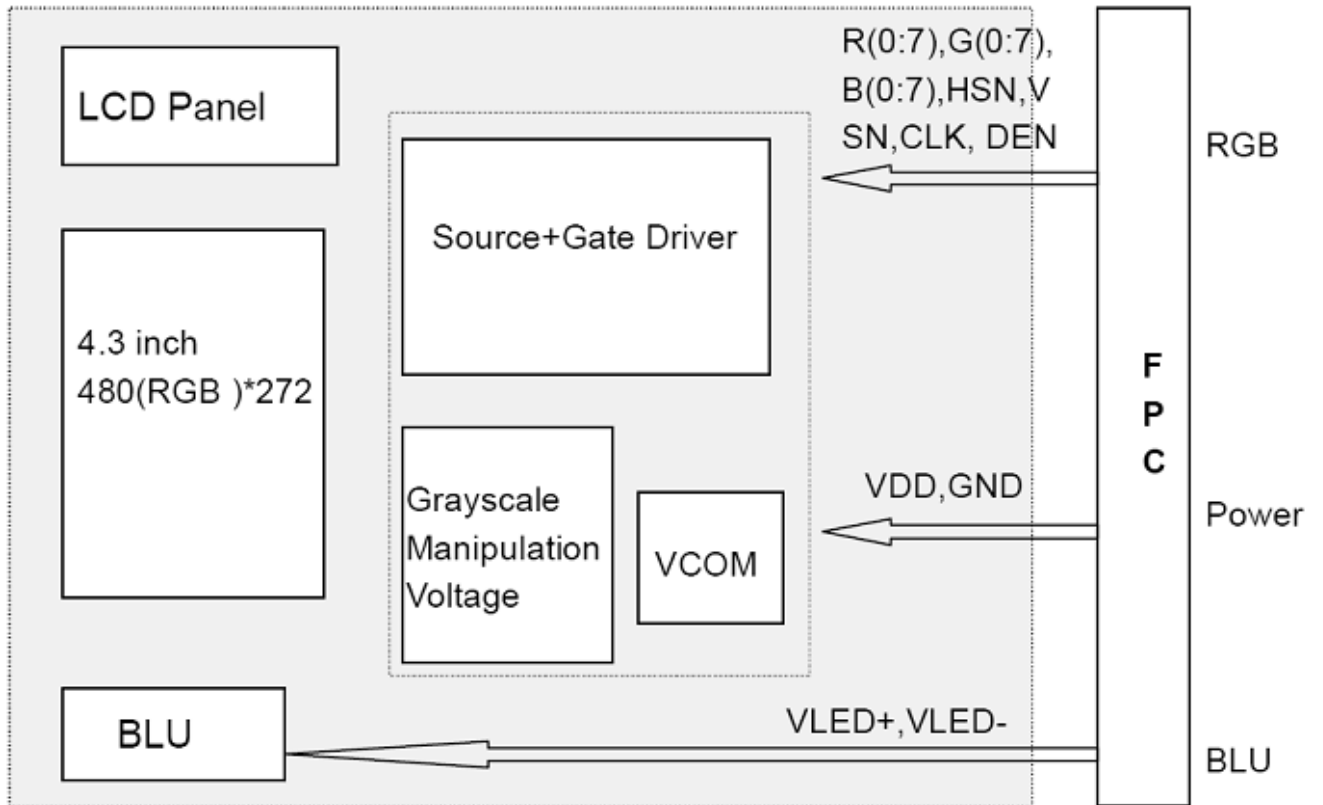

Figure: LED connection of backlight

Note2 : The "LED life time" is defined as the module brightness decrease to 50% of original brightness at Ta=25°C and IBL =40mA. The LED lifetime will be decreased if operating IBL is larger than 40mA.

7.3 Schematic of LCD module system



8. Command/AC Timing

8.1 Input Setup Timing Setting

8.1.1 Input Setup Timing Parameter Setting

VDD=3.3V Ta=25°C

Parameter	Symbol	Min	Typ	Max	Unit	Remark
DCLK Cycle Time	Tpw	66.7	-	-	ns	
DLCK Pulse High Width	Tpwh	26.7	-	-	ns	
DLCK Pulse Low Width	Tpwl	26.7	-	-	ns	
DE Setup Time	Tdes	10	-	-	ns	
DE Hold Time	Tdeh	10	-	-	ns	
HSYNC Setup Time	Ths	10	-	-	ns	
HSYNC Hold Time	Thh	10	-	-	ns	
VSYNC Setup Time	Tvhs	10	-	-	ns	
VSYNC Hold Time	Tvhh	10	-	-	ns	
Data Setup Time	Tds	10	-	-	ns	
Data Hold Time	Tdh	10	-	-	ns	
DISP Setup Time	Tdiss	10	-	-	us	
DISP Hold Time	Tdish	10	-	-	ms	

8.1.2 Input Setup Timing Diagram

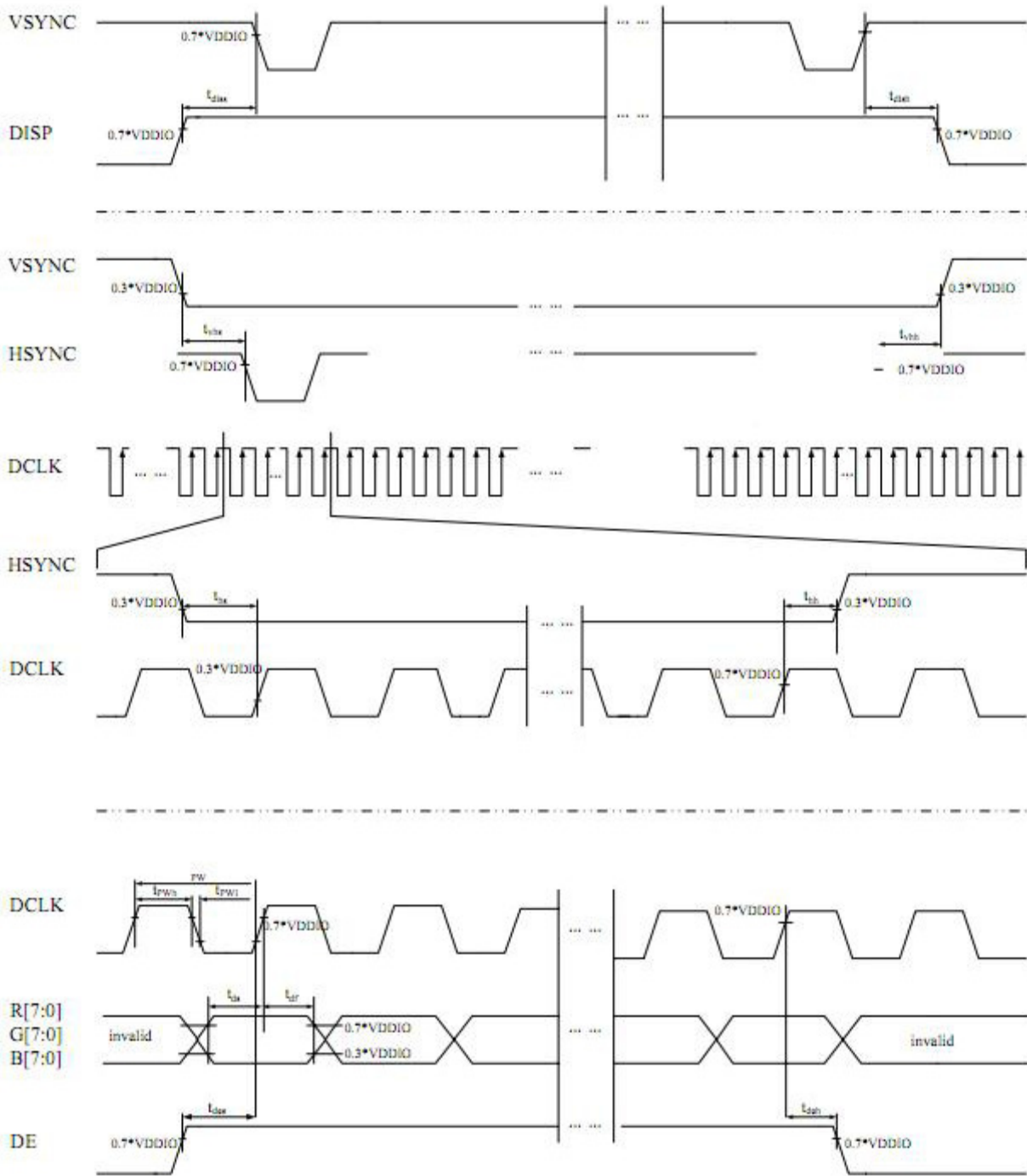

8.2 Data Input Format

8.2.1 Data Input Timing Parameter Setting

Parameter	Symbol	Min	Typ	Max	Unit	Remark
DCLK frequency	fclk	-	9	15	MHZ	
HSYNC frequency	1/th	-	17.14	-	KHZ	
VSYNC frequency	1/ty	-	59.94	-	HZ	
Horizontal cycle	th	525	525	605	DCLK	
Horizontal display period	thd	480			DCLK	
Horizontal pulse width	thp	2	41	41	DCLK	
Horizontal back porch	thb	2	2	41	DCLK	
Horizontal front porch	thf	2	2	82	DCLK	
Vertical cycle	tv	285	286	399	HSYNC	
Vertical display period	tvd	272			HSYNC	
Vertical pulse width	tvp	1	10	11	HSYNC	
Vertical back porch	tvb	1	2	11	HSYNC	
Vertical front porch	tvf	1	2	227	HSYNC	

Note1:Unit:CLK=1/fclk,H=th

Note2:It is necessary to keep tvp+tvb=12 and thp+thb=43 in sync mode.DE mode is unnecessary to keep it.

8.2.2 Data Input Timing Diagram
8.2.2.1 Data Input Timing Diagram

SYNC MODE

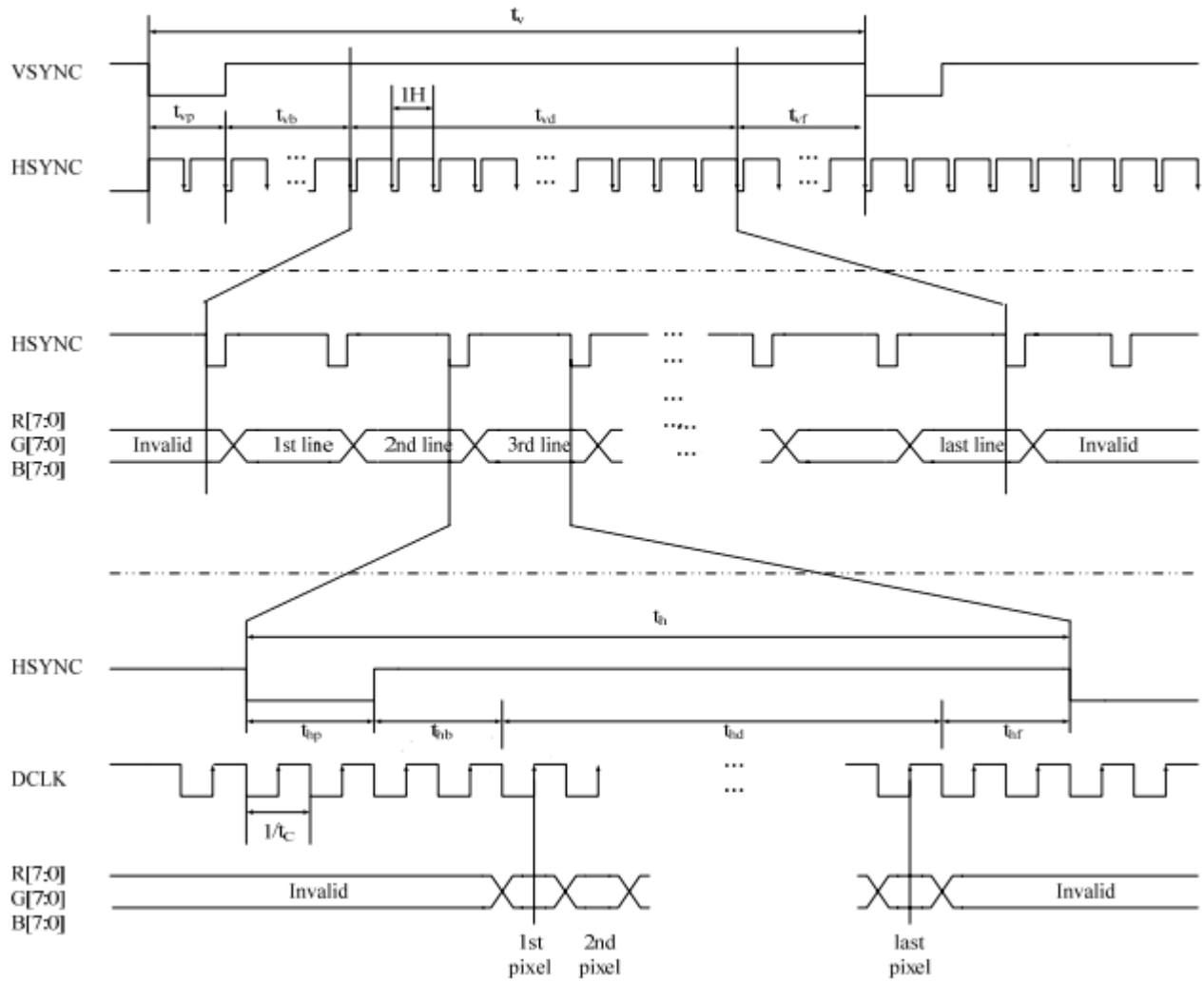

8.2.2.2 Data Input Timing Diagram under DE Mode

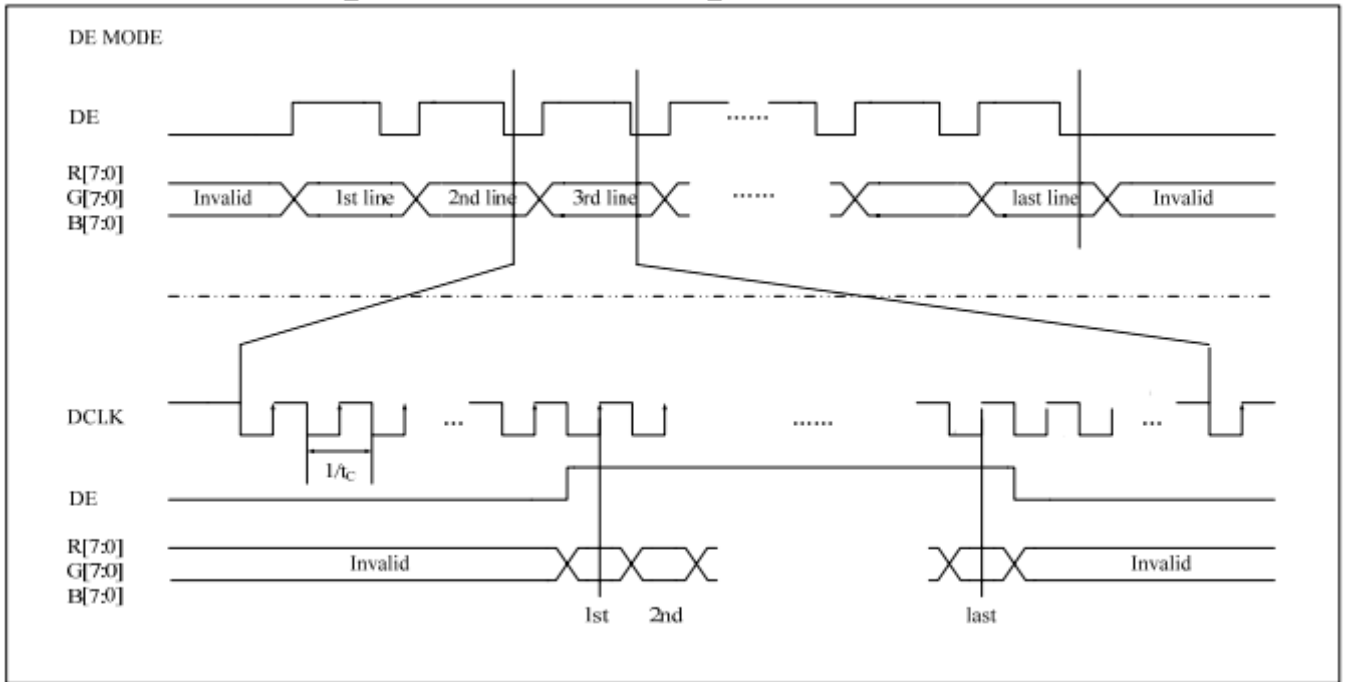

8.3 Power ON/OFF Sequence

8.3.1 Power ON Sequence

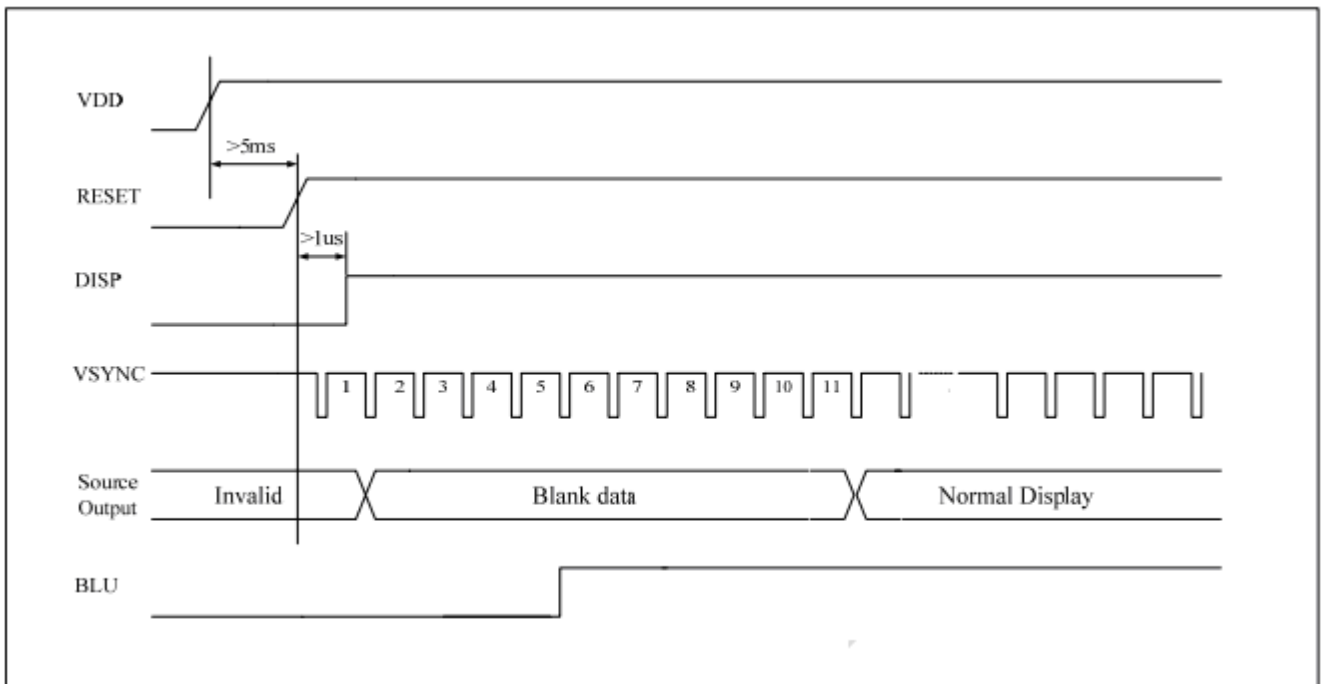

8.3.2 Power OFF Sequence

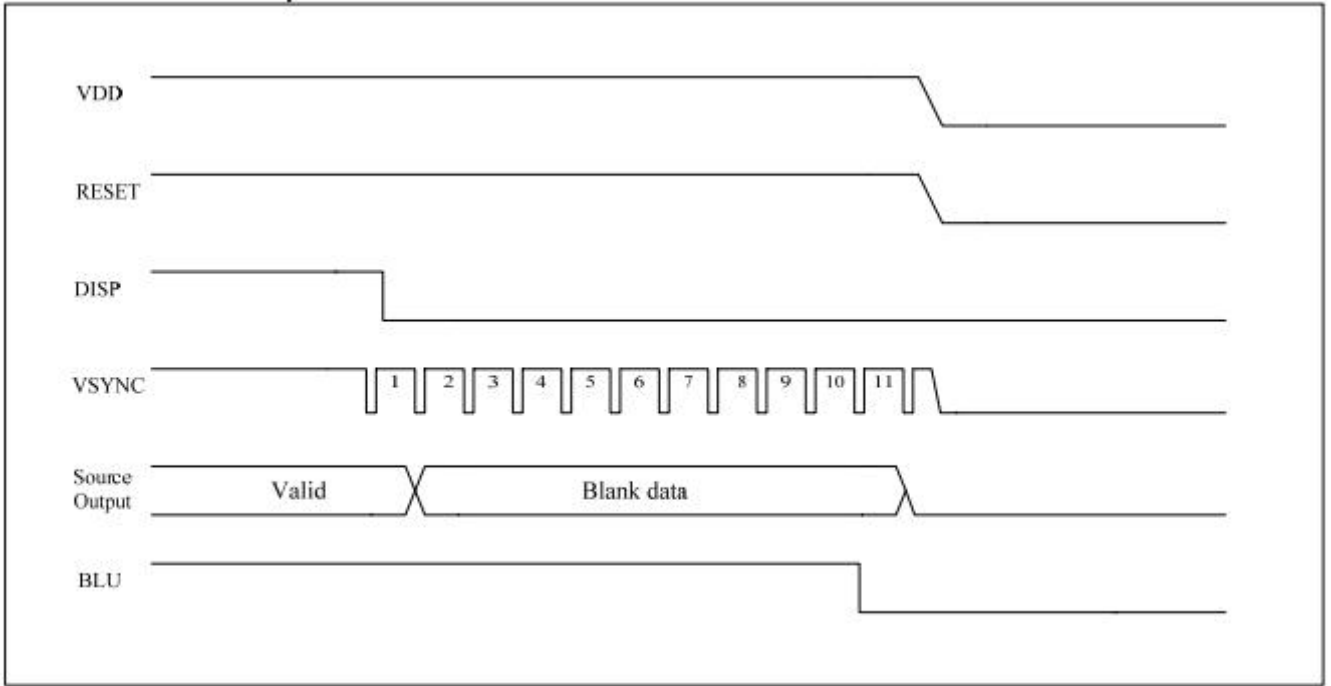

9. Optical Specification

Ta=25°C

Item	Symbol	Condition	Min	Typ.	Max.	Unit	Remark
Contrast Ratio	CR	$\theta=0^\circ$	350	500	-		Note1 Note2
Response Time	Ton/ Toff	25°C	-	20	30	ms	Note1 Note3
View Angles	ΘT	$CR \geq 10$	-	65	-	Degree	Note 4
	ΘB		-	55	-		
	ΘL		-	65	-		
	ΘR		-	65	-		
Chromaticity	White	Brightness is on	x	0.294	0.314	0.334	Note5, Note1
			y	0.324	0.344	0.364	
	Red		x	0.631	0.651	0.671	
			y	0.311	0.331	0.351	
	Green		x	0.296	0.316	0.336	
			y	0.553	0.573	0.593	
	Blue		x	0.118	0.138	0.158	
			y	0.111	0.131	0.151	
NTSC	S			50		%	Note5
Luminance	L		-	500	-	cd/m ²	Note1 Note6
Uniformity	U		75	80	-	%	Note1 Note7

Note 1: Definition of optical measurement system.

Temperature = 25°C(±3°C)

LED back-light: ON, Environment brightness < 150 lx

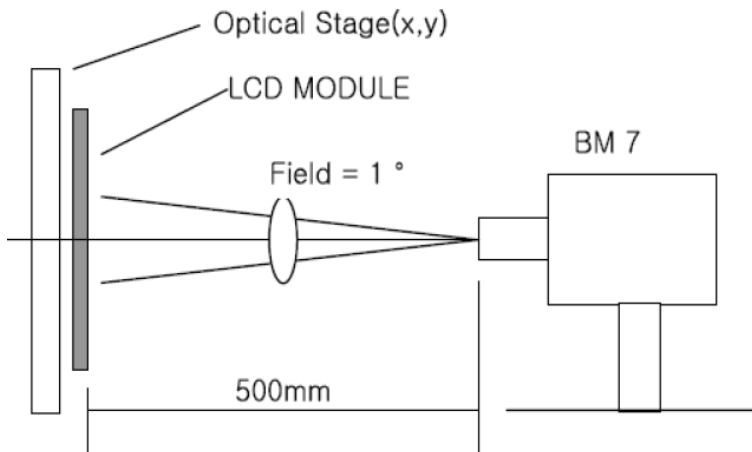

Note 2: Contrast ratio is defined as follow:

$$\text{Contrast Ratio} = \frac{\text{Surface Luminance with all white pixels}}{\text{Surface Luminance with all black pixels}}$$

Note 3: Response time is defined as follow:

Response time is the time required for the display to transition from black to white (Rise Time, Tr) and from white to black(Decay Time, Tf).

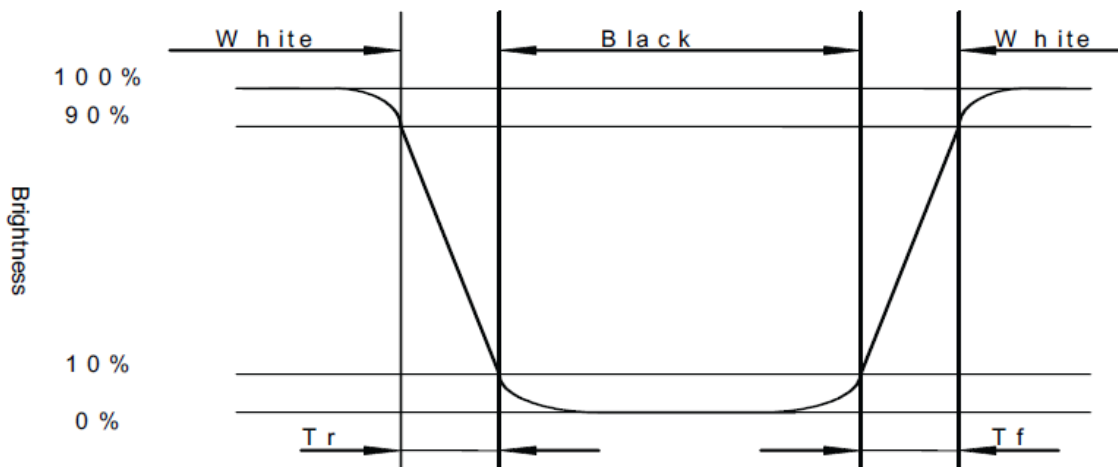

Note 4: Viewing angle range is defined as follow:

Viewing angle is measured at the center point of the LCD.

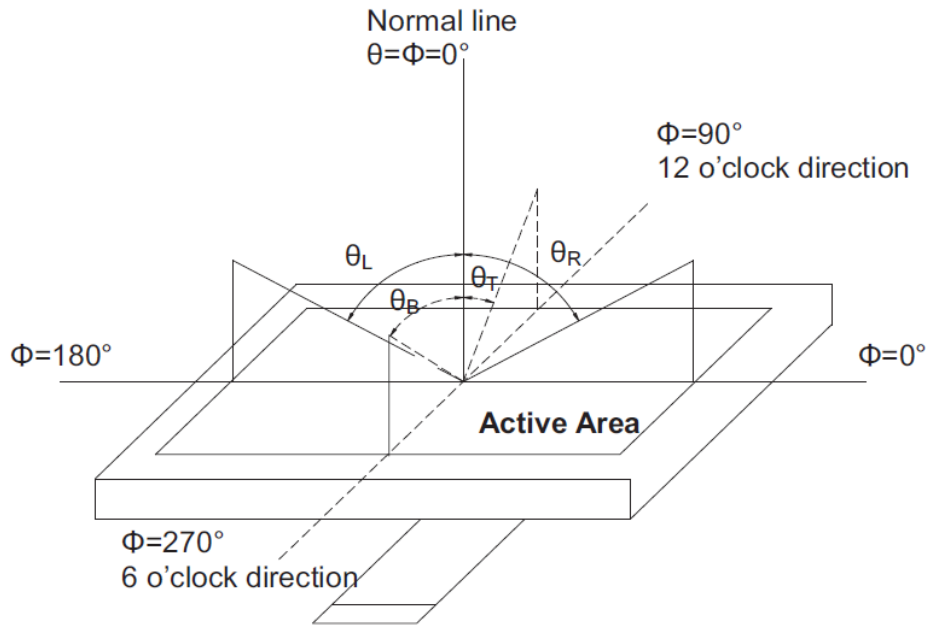

Note 5: Color chromaticity is defined as follow: (CIE1931)

Color coordinates measured at center point of LCD.

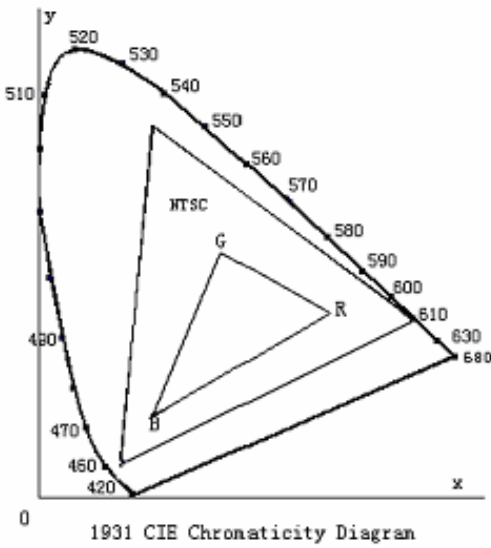

$$S = \frac{\text{area of RGB triangle}}{\text{area of NTSC triangle}} \times 100\%$$

Note 6: Luminance is defined as follow:

Luminance is defined as the brightness of all pixels “White” at the center of display area on optimum contrast.

Note 7: Luminance Uniformity is defined as follow:

Active area is divided into 9 measuring areas (Refer Fig. 2). Every measuring point is placed at the center of each measuring area.

$$\text{Uniformity}(U) = \frac{\text{Minimum Luminance(brightness) in 9 points}}{\text{Maximum Luminance(brightness) in 9 points}}$$

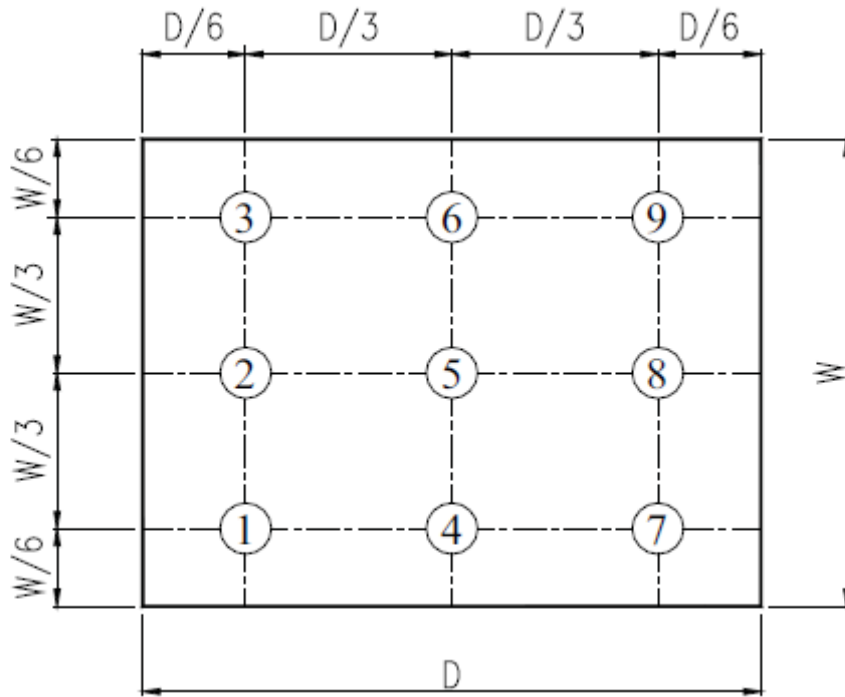

Fig. 2 Definition of uniformity

10. Environmental / Reliability Tests

No	Test Item	Condition	Judgment criteria
1	High Temp Operation	Ts=+80°C, 120hrs	Per table in below
2	Low Temp Operation	Ta=-30°C, 120hrs	Per table in below
3	High Temp Storage	Ta=+80°C, 120hrs	Per table in below
4	Low Temp Storage	Ta=-30°C, 120hrs	Per table in below
5	High Temp & High Humidity Storage	Ta=+60°C, 90% RH 120 hours	Per table in below (polarizer discoloration is excluded)
6	Thermal Shock (Non-operation)	-30°C 30 min~+80°C 30 min, Change time:5min, 10 Cycles	Per table in below
7	ESD (Operation)	C=150pF, R=330Ω · 5points/panel Air:±8KV, 5times; Contact:±4KV, 5 times;	Per table in below
8	Vibration (Non-operation)	Frequency range:10~55Hz, Stroke:1.5mm Sweep:10Hz~55Hz~10Hz 2 hours for each direction of X.Y.Z.	Per table in below
9	Shock (Non-operation)	60G 6ms, ±X,±Y,±Z 3times, for each direction	Per table in below
10	Package Drop Test	Height:80 cm, 1 corner, 3 edges, 6 surfaces	Per table in below

INSPECTION	CRITERION(after test)
Appearance	No Crack on the FPC, on the LCD Panel
Alignment of LCD Panel	No Bubbles in the LCD Panel No other Defects of Alignment in Active area
Electrical current	Within device specifications
Function / Display	No Broken Circuit, No Short Circuit or No Black line No Other Defects of Display

11. Precautions for Use of LCD Modules

11.1 Safety

The liquid crystal in the LCD is poisonous. Do not put it in your mouth. If the liquid crystal touches your skin or clothes, wash it off immediately using soap and water.

11.2 Handling

A. The LCD and touch panel is made of plate glass. Do not subject the panel to mechanical shock or to excessive force on its surface.

B. Do not handle the product by holding the flexible pattern portion in order to assure the reliability

C. Transparency is an important factor for the touch panel. Please wear clear finger sacks, gloves and mask to protect the touch panel from finger print or stain and also hold the portion outside the view area when handling the touch panel.

D. Provide a space so that the panel does not come into contact with other components.

E. To protect the product from external force, put a covering lens (acrylic board or similar board) and keep an appropriate gap between them.

F. Transparent electrodes may be disconnected if the panel is used under environmental conditions where dew condensation occurs.

G. Property of semiconductor devices may be affected when they are exposed to light, possibly resulting in IC malfunctions.

H. To prevent such IC malfunctions, your design and mounting layout shall be done in the way that the IC is not exposed to light in actual use.

11.3 Static Electricity

A. Ground soldering iron tips, tools and testers when they are in operation.

B. Ground your body when handling the products.

C. Power on the LCD module before applying the voltage to the input terminals.

D. Do not apply voltage which exceeds the absolute maximum rating.

E. Store the products in an anti-electrostatic bag or container.

F. Peel off the LCM protective film slowly since static electricity may be generated.

11.4 Storage

A. Store the products in a dark place at $+25^{\circ}\text{C} \pm 10^{\circ}\text{C}$ with low humidity (40% RH to 60% RH). Don't expose to sunlight or fluorescent light.

B. Storage in a clean environment, free from dust, active gas, and solvent.

11.5 Cleaning

A. Do not wipe the touch panel with dry cloth, as it may cause scratch.

B. Wipe off the stain on the product by using soft cloth moistened with ethanol. Do not allow ethanol to get in between the upper film and the bottom glass. It may cause peeling issue or defective operation. Do not use any organic solvent or detergent other than ethanol.

11.6 Cautions for installing and assembling

Bezel edge must be positioned in the area between the Active area and View area. The bezel may press the touch screen and cause activation if the edge touches the active area. A gap of approximately 0.5mm is needed between the bezel and the top electrode. It may cause unexpected activation if the gap is too narrow. There is a tolerance of 0.2 to 0.3mm for the outside dimensions of the touch panel and tail. A gap must be made to absorb the tolerance in the case and connector.

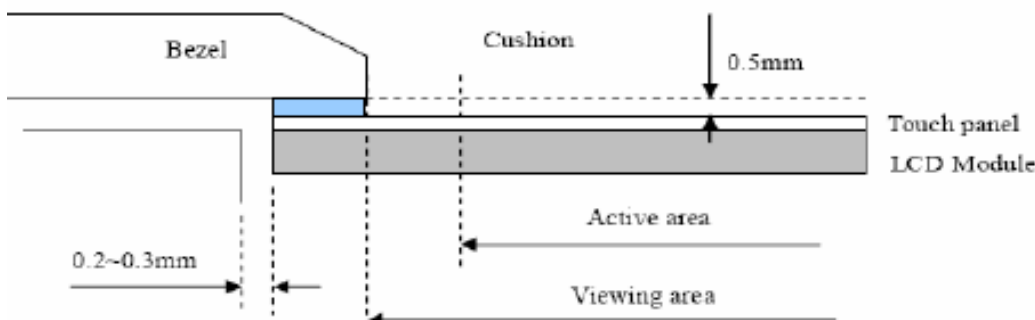

X-ON Electronics

Largest Supplier of Electrical and Electronic Components

Click to view similar products for [TFT Displays & Accessories category](#):

Click to view products by [Microtips manufacturer](#):

Other Similar products are found below :

[F3ET2-005-150](#) [HDA430T-3G1H](#) [NL6448BC20-21D](#) [NB7W-KBA04](#) [NB-ATT01](#) [NB5Q-ATT01](#) [NB5Q-KBA04](#) [NB-CN001](#) [OAI-80038AA-2008-A](#) [315-U004B15300](#) [UMSH-8596MD-34T \(REV D\)](#) [TCG121WXLRXVNNANX35](#) [EIC-LCD-1080P](#) [T-55619GD065J-LW-ABN](#) [TCG104SVLPEANN-AN30](#) [NL6448BC33-70](#) [NL6448BC20-30D](#) [NL10276BC16-06](#) [NL192108AC10-01D](#) [NL12880BC20-05BD](#) [NL8060BC26-35BA](#) [NL8060BC31-50F](#) [TM070DDHG03-40](#) [NL10276AC30-42C](#) [PTPW16-070WV1S02](#) [PTPW17-070WV1S02](#) [PTPW16-084SV1S02](#) [MTD0300ECP06DF-1](#) [DEM 320240T VMX-PW-N \(A-TOUCH\)](#) [DEM 480128B TMH-PW-N \(A-TOUCH\)](#) [DEM 480272P VMX-PW-N \(C-TOUCH\)](#) [DEM 480272Q VMX-PW-N \(A-TOUCH\)](#) [DEM 480272Q VMX-PW-N \(C-TOUCH\)](#) [DEM 640480E TMH-PW-N \(A-TOUCH\)](#) [DEM 800480K1 TMH-PW-N \(A-TOUCH\)](#) [DEM 800480K1 TMH-PW-N \(C-TOUCH\)](#) [DEM 800480K2 TMH-PW-N \(A-TOUCH\)](#) [DEM 800480K3 TMH-PW-N \(C-TOUCH\)](#) [DEM 800480K4 TMH-PW-N \(A-TOUCH\)](#) [DEM 800480K4 TMH-PW-N \(C-TOUCH\)](#) [4DLCD-35480320-CTP-IPS](#) [4DLCD-35480320-IPS](#) [4DLCD-35480320-RTP-IPS](#) [4DLCD-50800480-CTP-IPS](#) [RFA6400E-AWH-DNG](#) [RFA6400E-AWH-MNN](#) [RFE430V-AZW-DNS](#) [RFF70VA2-1IW-DHS](#) [RFH700A8-AYH-MNN](#) [RFK101VF-1YH-LHG](#)