

The logo features a stylized graphic of three vertical bars on the left, each composed of multiple parallel diagonal lines. The leftmost bar is red, the middle bar is green, and the rightmost bar is blue. To the right of this graphic, the word "Microtips" is written in a large, bold, black serif font. Below "Microtips", a thick horizontal black line spans the width of the text. Underneath this line, the word "TECHNOLOGY" is written in a smaller, black, all-caps serif font, with wide letter spacing.

Microtips

TECHNOLOGY

Model No: MTÖ€î î Œ Š

TEL: 1-888-499-TIPS (8477)

FAX: (407) 273-0771

E-MAIL: mtusainfo@microtipsusa.com

WEB: www.microtipsusa.com

Record of Revision

Date	Revision No.	Summary
2016-08-23	1.0	Rev 1.0 was issued
2016-11-18	1.1	Update the interface.
2016-11-25	1.2	Revise the pin definition

1. Scope

This data sheet is to introduce the specification of **MTD0686AML**, active matrix TFT module. It is composed of a color TFT-LCD panel, driver ICs, FPC and a backlight unit. The 6.8" display area contains 480x(RGB)x1280 pixels.

2. Application

Digital equipments which need color display, mobile navigator/video systems.

3. General Information

Item	Contents	Unit
Size	6.8	inch
Resolution	480x(RGB)x1280	/
Interface	LVDS	/
Technology type	IPS	/
Pixel Configuration	R.G.B Vertical Stripe	
Outline Dimension (W x H x D)	66.8 x 181.0 x 4.5	mm
Active Area	60.22 x 160.59	mm
View Direction	All	O'Clock
Display Mode	Transmissive	/
Backlight Type	LED	/
Suggested Driver IC	EK79030	/

4. Outline Drawing

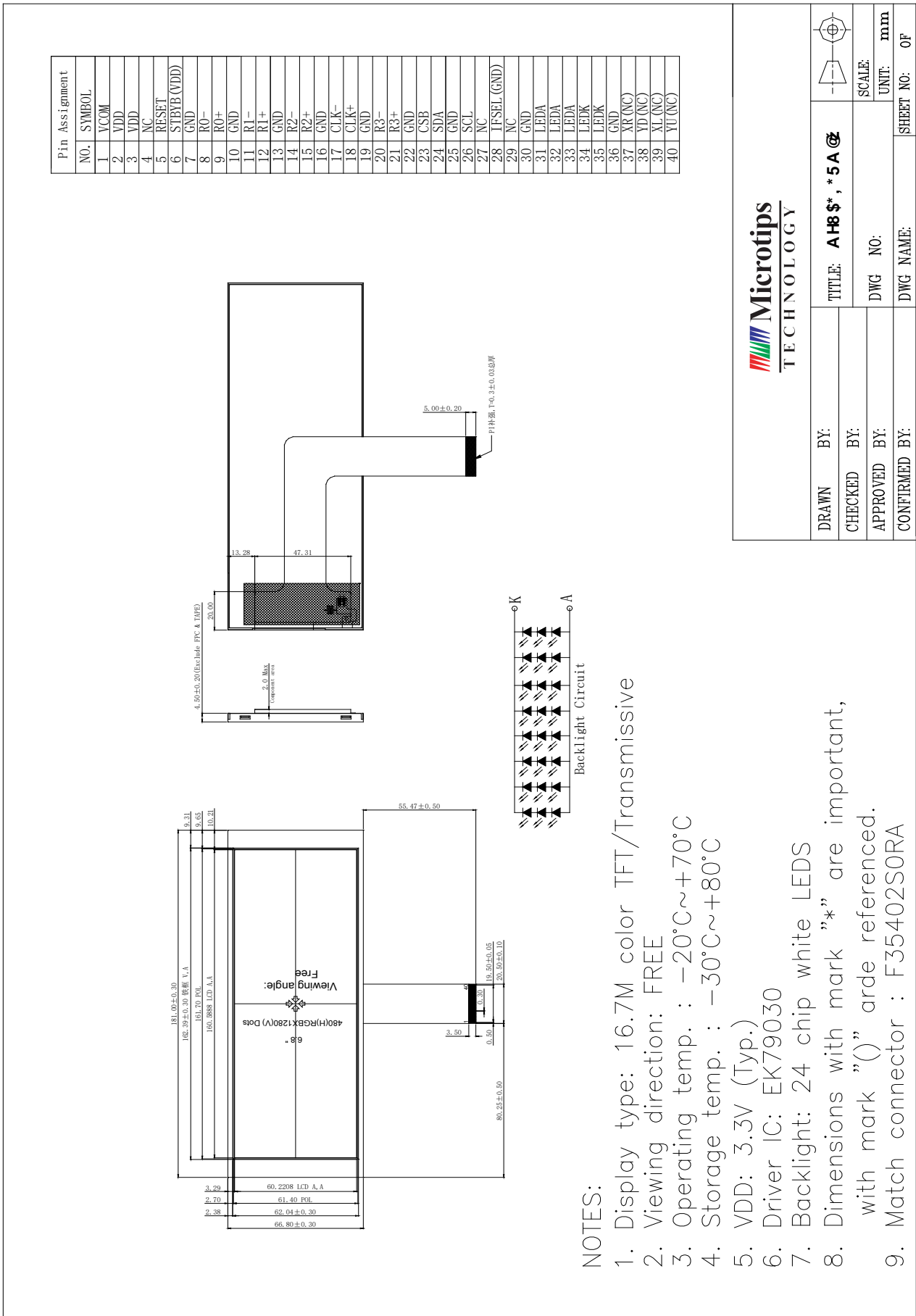

5. Interface signals

No	Symbol	Description	Remark
1	VCOM	Common voltage output. Connect a capacitor to GND.	
2	VDD	Supply voltage for the analog circuit. (+3.3V)	
3	VDD		
4	NC	No connection	
5	RESET	Chip reset signal. Active "Low"	
6	STBYB(VDD)	Standby mode selection. STBYB="0", Standby mode STBYB="1", Normal display mode	
7	GND	Power Ground	
8	R0-	LVDS-DSI data Lane 0 negative-end input/output pin	
9	R0+	LVDS-DSI data Lane 0 positive-end input pin	
10	GND	Power Ground	
11	R1-	LVDS-DSI data Lane 1 negative-end input/output pin	
12	R1+	LVDS-DSI data Lane 1 positive-end input pin	
13	GND	Power Ground	
14	R2-	LVDS-DSI data Lane 2 negative-end input/output pin	
15	R2+	LVDS-DSI data Lane 2 positive-end input pin	
16	GND	Power Ground	
17	CLK-	LVDS-DSI clock Lane negative-end input pin	
18	CLK+	LVDS-DSI clock Lane positive-end input pin	
19	GND	Power Ground	
20	R3-	LVDS-DSI data Lane 3 negative-end input/output pin	
21	R3+	LVDS-DSI data Lane 3 positive-end input pin	
22	GND	Power Ground	
23	CSB	Serial communication enables. Normally pull high or open	
24	SDA	Serial communication data input. Normally pull high or open	
25	GND	Power Ground	
26	SCL	Serial communication clock input. Normally pull high or open	
27	NC	No connection	
28	IFSEL(GND)	LVDS/MIPI Interface select pin. Pull Low	
29	NC	No connection	
30	GND	Power Ground	
31	LEDA	Backlight Anode	
32	LEDA	Backlight Anode	
33	LEDA	Backlight Anode	
34	LEDK	Backlight Cathode	
35	LEDK	Backlight Cathode	
36	GND	Power Ground	
37	XR(NC)	No connection	
38	YD(NC)	No connection	
39	XL(NC)	No connection	
40	YU(NC)	No connection	

6. Absolute maximum Ratings

6.1. Electrical Absolute max. ratings

Parameter	Symbol	MIN	MAX	Unit	Remark
Logic Supply Voltage	VDD	-0.3	4	V	Ta=25°C
Backlight input voltage	LEDA	8.6	10	V	

Note: The module may be destroyed and not be recovered while the absolute maximum rating values of this product have been exceeded

6.2. Environment Conditions

Item	Symbol	MIN	MAX	Unit	Remark
Operating Temperature	TOPR	-20	70	°C	
Storage Temperature	TSTG	-30	80	°C	

6.3. LED Backlight Absolute max. ratings

Item	Symbol	MIN	MAX	Unit	Remark
LED Forward Current	I _{LED}	--	25	mA	For each LED
LED Reverse Voltage	V _R	--	1.2	V	

7. Electrical Specifications

7.1 Electrical characteristics (operating condition)

Item	Symbol	MIN	TYP	MAX	Unit	Remark
Power supply voltage	VDD	3.0	3.3	3.6	V	
Common voltage output	VCOM	-2.75	-1.48	-0.2	V	

7.2 DC electrical characteristics

Parameter	Symbol	Min	Typ	Max	Unit
VDDIO Input high level voltage	V _{IH}	0.8 x VDDIO		VDDIO	V
VDDIO input low level voltage	V _{IL}	VSS		0.2 x VDDIO	V
Input Leakage Current	I _{leak}	(-1)		(+1)	uA
VGL_REG2 output voltage	VGL_REG2				V
VGMP output voltage	VGMP				V
VGMPN output voltage	VGMPN				V
VCI1 output voltage	VCI1				V
VGL output voltage	VGL_O	-16		-6	V
VGH output voltage	VGH_O	8		19	V
VCL output voltage	VCL	-2.1	-2.4	-3	V
VOM output voltage	VCOM	-2.75	-1.48	-0.2	V
Input terminal resistance	ZID		100		ohm

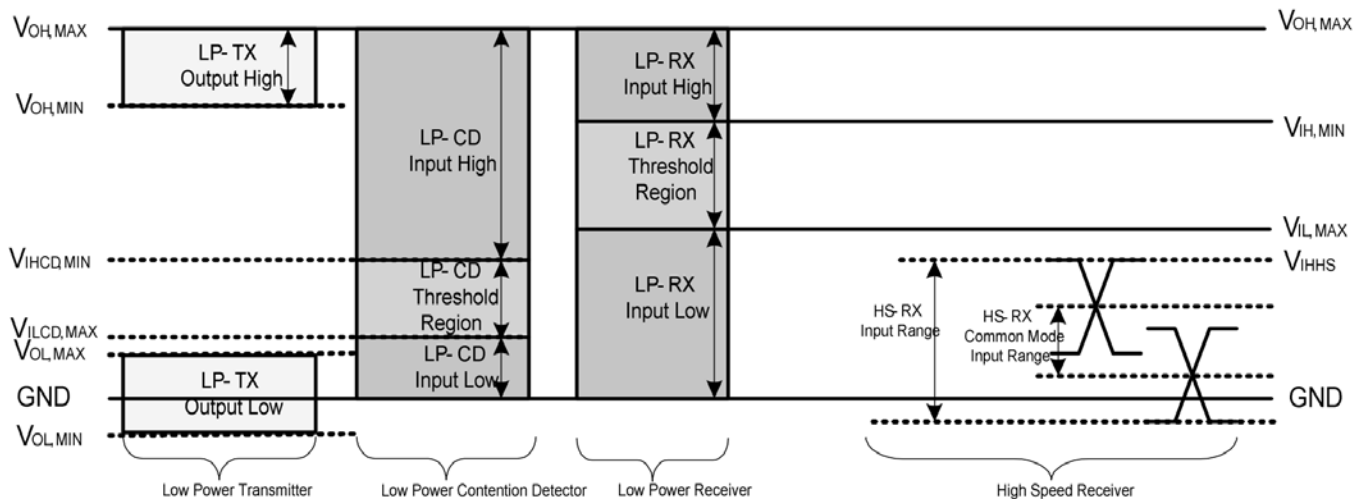

7.3 LED Backlight

Ta=25°C

Item	Symbol	MIN	TYP	MAX	Unit	Remark
VLED Supply Voltage	Vled	-	9.6	-	V	
VLED Supply Current	Iled	-	160	-	mA	

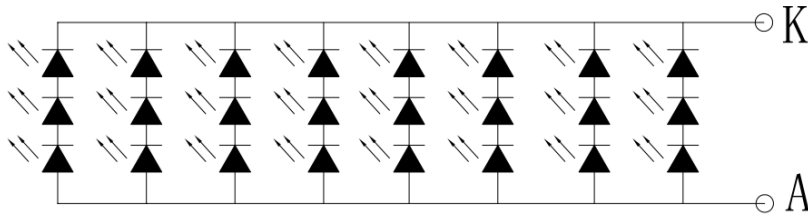

7.4 Function Block Diagram

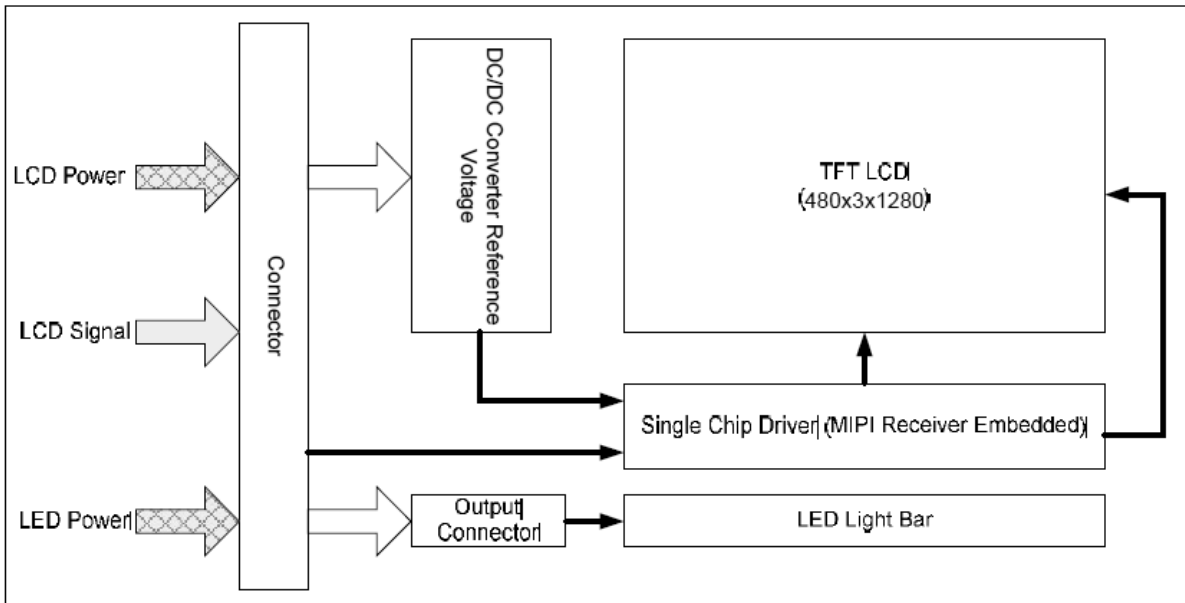

Pixel Format :

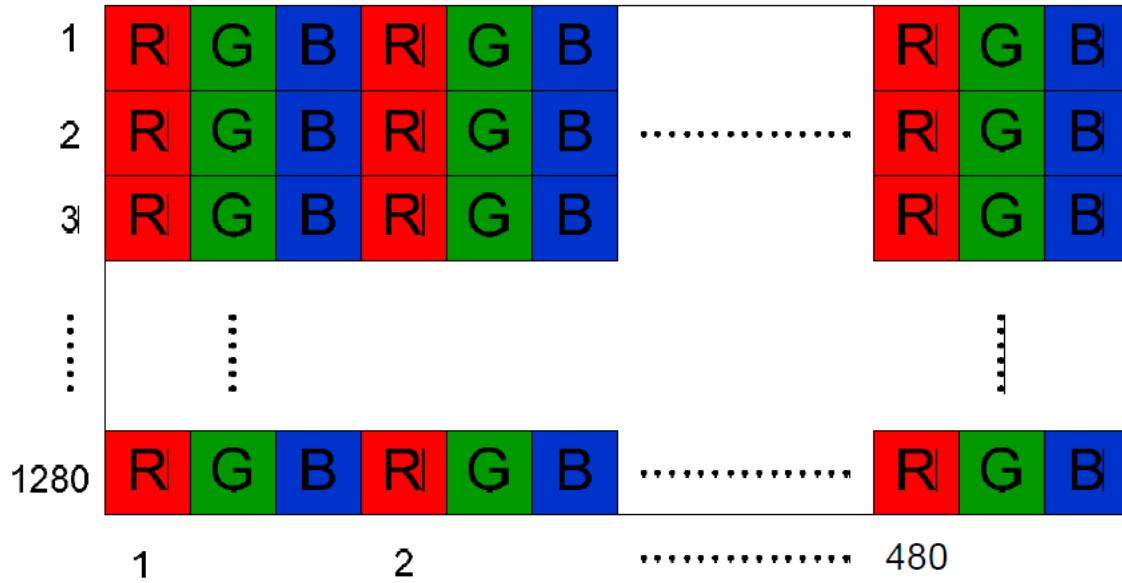

Note:

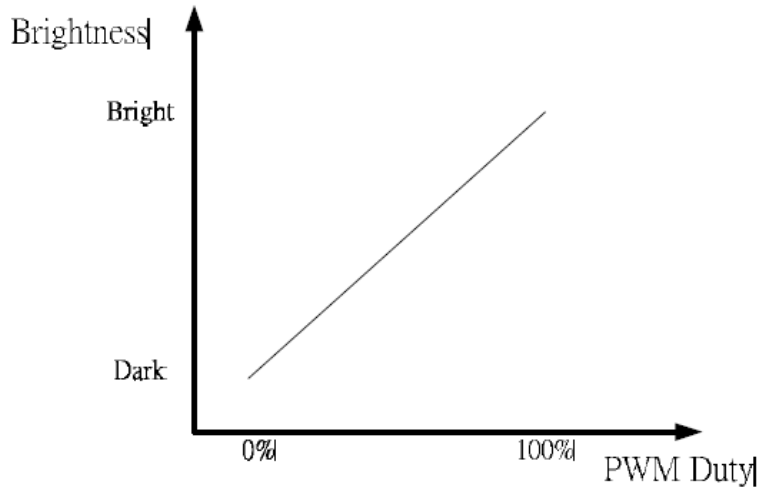

8. Command/AC Timing

8.1 LVDS mode AC Electrical Characteristics

Parameter	Symbol	Spec.			Unit	Condition
		Min.	Typ.	Max.		
Clock frequency	R_{xFCLK}	30	-	-	Mhz	Refer to input timing table for each display resolution
Input data skew margin	T_{RSKM}	500	-	-	ps	$ VID = 200mV$ $RxVCM = 1.2V$ $RxFCLK = 81MHz$
Clock high time	T_{LVCH}	-	$4/(7 * R_{xFCLK})$	-	ns	
Clock low time	T_{LVCL}	-	$3/(7 * R_{xFCLK})$	-	ns	
PLL wake-up time	T_{enPLL}	-	-	150	us	

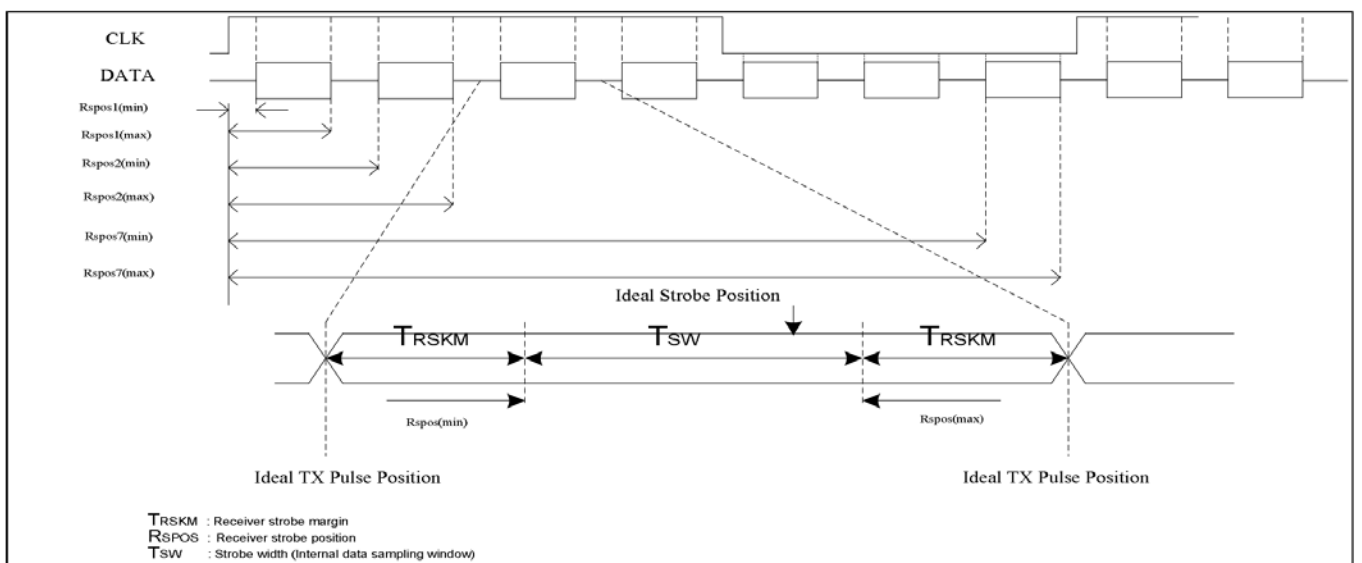
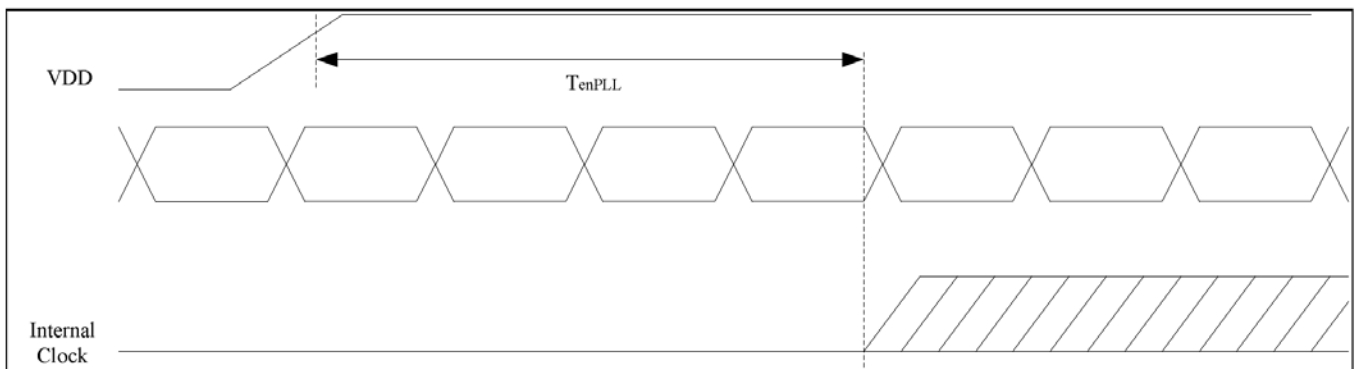
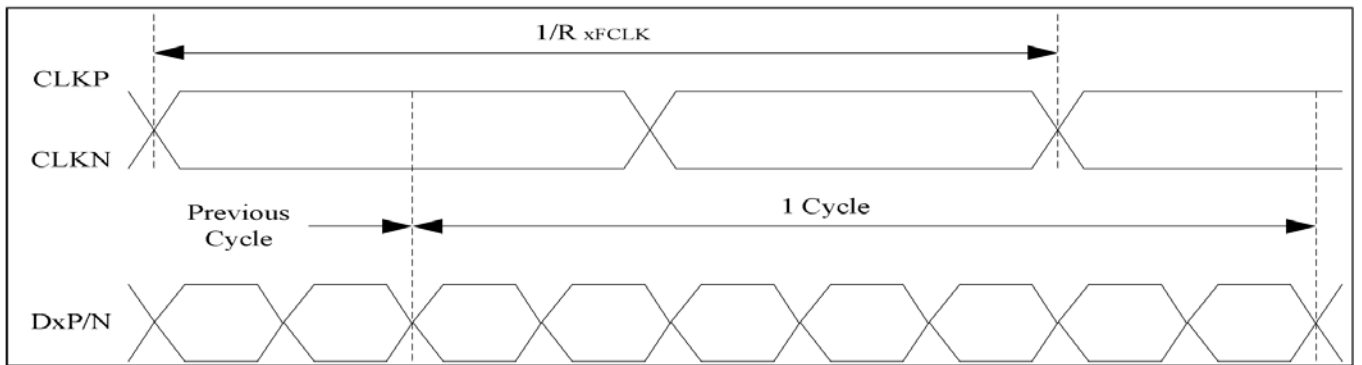

8.2 Data input format for LVDS

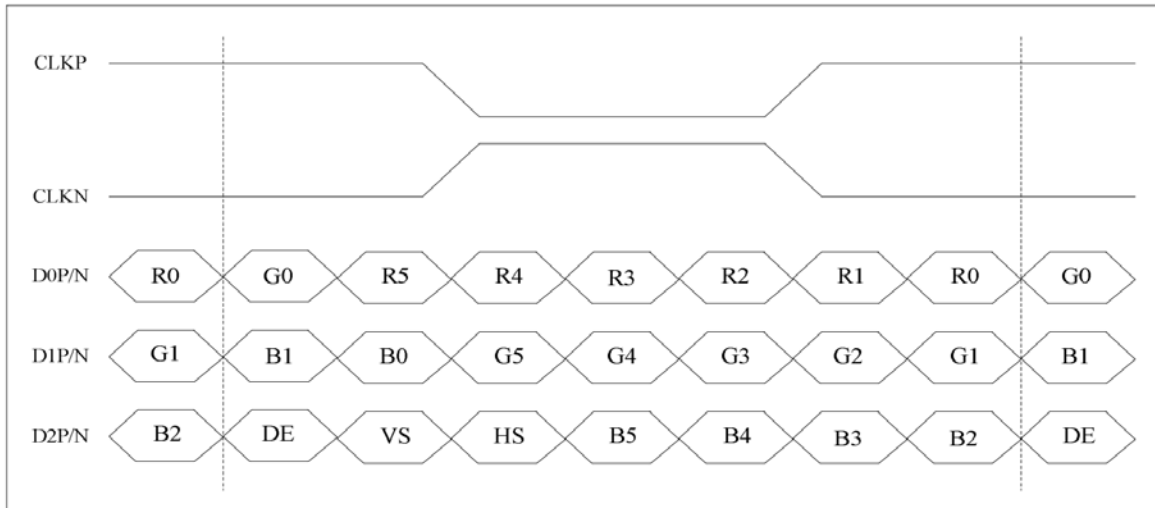

6-bit LVDS input (LVBIT=L, LVFMT=Don't care)

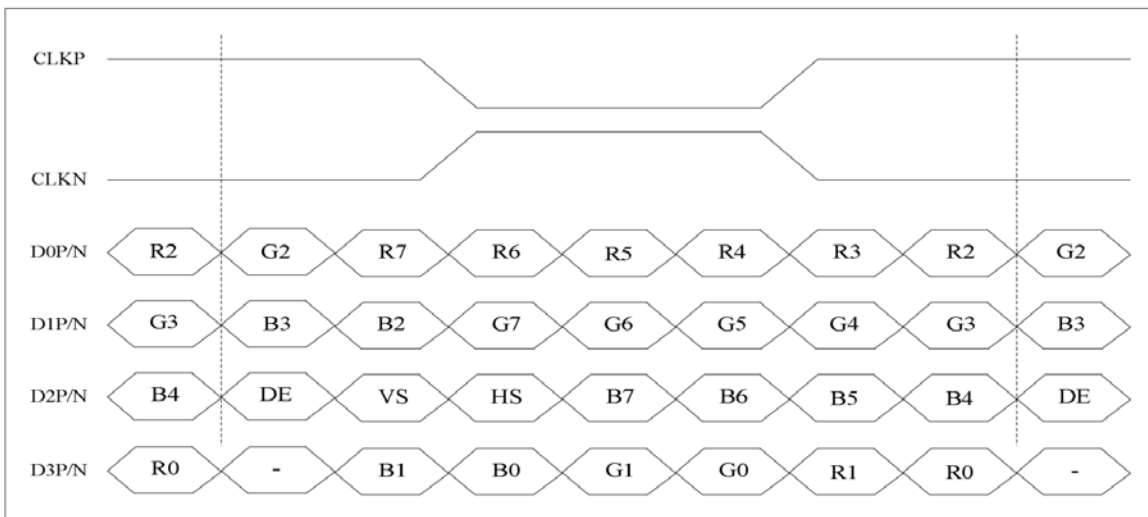

8-bit LVDS input (LVBIT=H, LVFMT=L)

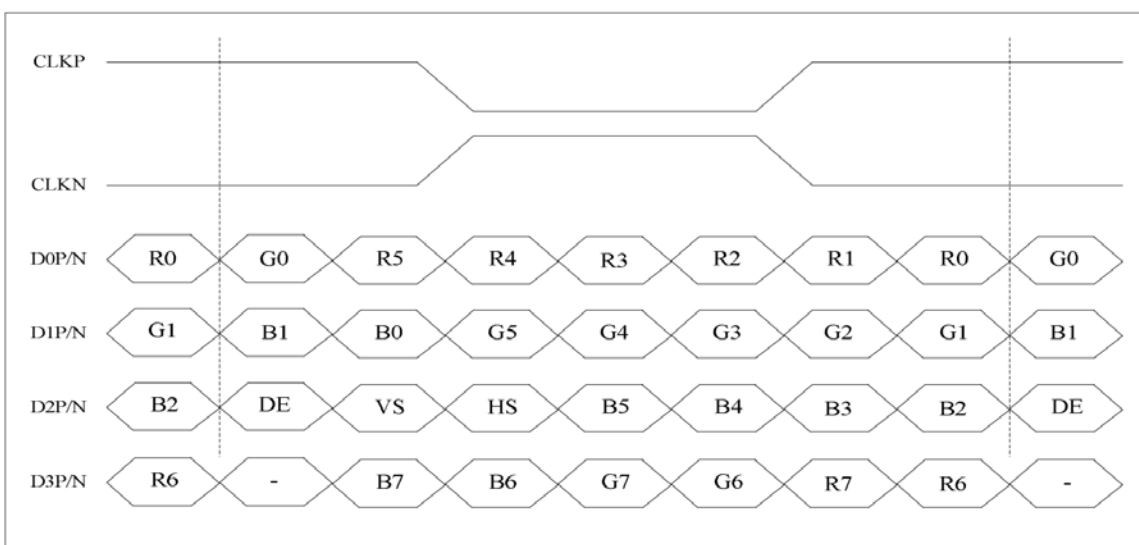

8-bit LVDS input(LVBIT=H, LVFMT=H)

8.3 LVDS/MIPI input Timing Table

Parameter	Symbol	Spec.			Unit
		Min.	Typ.	Max.	
MIPI (4 Lane) @Frame rate=60Hz			349		Mbps
MIPI (3 Lane) @Frame rate=60Hz			465		Mbps
DCLK frequency @Frame rate=60Hz	F _{DCLK}		58.2		MHz
HSYNC period time	T _H		744		DCLK
Horizontal display area	T _{HD}	480			DCLK
HSYNC pulse width	T _{HPW}		24		DCLK
HSYNC back porch	T _{HBP}		160		DCLK
HSYNC front porch	T _{FBP}		160		DCLK
VSYNC period time	T _V		1304		H
Vertical display area	T _{VD}	1280			H
VSYNC pulse width	T _{VPW}		2		H
VSYNC back porch	T _{VBP}		10		H
VSYNC front porch	T _{VFP}		12		H

8.4 Data mapping

	INPUT DATA	R7	R6	R5	R4	R3	R2	R1	R0	G7	G6	G5	G4	G3	G2	G1	G0	B7	B6	B5	B4	B3	B2	B1	B0
		MSB							LSB	MSB							LSB	MSB							LSB
BASIC COLOR	BLACK	0	0	0	0	0	0	0	0	0	0	0	0	0	0	0	0	0	0	0	0	0	0	0	0
	RED(255)	1	1	1	1	1	1	1	1	0	0	0	0	0	0	0	0	0	0	0	0	0	0	0	0
	GREEN(255)	0	0	0	0	0	0	0	0	1	1	1	1	1	1	1	1	0	0	0	0	0	0	0	0
	BLUE(255)	0	0	0	0	0	0	0	0	0	0	0	0	0	0	0	0	1	1	1	1	1	1	1	1
	CYAN	0	0	0	0	0	0	0	0	1	1	1	1	1	1	1	1	1	1	1	1	1	1	1	1
	MAGENTA	1	1	1	1	1	1	1	1	0	0	0	0	0	0	0	0	1	1	1	1	1	1	1	1
	YELLOW	1	1	1	1	1	1	1	1	1	1	1	1	1	1	1	1	0	0	0	0	0	0	0	0
	WHITE	1	1	1	1	1	1	1	1	1	1	1	1	1	1	1	1	1	1	1	1	1	1	1	1
RED	RED(0)	0	0	0	0	0	0	0	0	0	0	0	0	0	0	0	0	0	0	0	0	0	0	0	0
	RED(1)	0	0	0	0	0	0	0	1	0	0	0	0	0	0	0	0	0	0	0	0	0	0	0	0
	RED(2)	0	0	0	0	0	0	1	0	0	0	0	0	0	0	0	0	0	0	0	0	0	0	0	0
	RED(254)	1	1	1	1	1	1	1	0	0	0	0	0	0	0	0	0	0	0	0	0	0	0	0	0
RED(255)	1	1	1	1	1	1	1	1	0	0	0	0	0	0	0	0	0	0	0	0	0	0	0	0	
GREEN	GREEN(0)	0	0	0	0	0	0	0	0	0	0	0	0	0	0	0	0	0	0	0	0	0	0	0	0
	GREEN(1)	0	0	0	0	0	0	0	0	0	0	0	0	0	0	0	1	0	0	0	0	0	0	0	0
	GREEN(2)	0	0	0	0	0	0	0	0	0	0	0	0	0	0	1	0	0	0	0	0	0	0	0	0
	GREEN(254)	0	0	0	0	0	0	0	0	1	1	1	1	1	1	1	0	0	0	0	0	0	0	0	0
GREEN(255)	0	0	0	0	0	0	0	0	1	1	1	1	1	1	1	1	0	0	0	0	0	0	0	0	
BLUE	BLUE(0)	0	0	0	0	0	0	0	0	0	0	0	0	0	0	0	0	0	0	0	0	0	0	0	0
	BLUE(1)	0	0	0	0	0	0	0	0	0	0	0	0	0	0	0	0	0	0	0	0	0	0	0	1
	BLUE(2)	0	0	0	0	0	0	0	0	0	0	0	0	0	0	0	0	0	0	0	0	0	0	1	0
	BLUE(254)	0	0	0	0	0	0	0	0	0	0	0	0	0	0	0	0	1	1	1	1	1	1	1	0
BLUE(255)	0	0	0	0	0	0	0	0	0	0	0	0	0	0	0	0	1	1	1	1	1	1	1	1	

9. Optical Specification

Ta=25°C

Item	Symbol	Condition	Min	Typ.	Max.	Unit	Remark
Contrast Ratio	CR	$\theta=0^\circ$	700	900	-		Note1 Note2
Response Time	Ton + Toff	25°C	- -	25	35	ms	Note1 Note3
View Angles	ΘT	$CR \geq 10$	70	80	-	Degree	Note 4
	ΘB		70	80	-		
	ΘL		70	80	-		
	ΘR		70	80	-		
Chromaticity	White	Brightness is on	x	0.284	0.314	0.344	Note5, Note1
			y	0.322	0.352	0.382	
Luminance	L		400	450	-	cd/m ²	Note1 Note6
Uniformity	U		75		-	%	Note1 Note7

Test condition: VDD=3.3V, the ambient temperature is 25°C.

Note 1: Definition of optical measurement system.

Temperature = 25°C(±3°C)

LED back-light: ON, Environment brightness < 150 lx

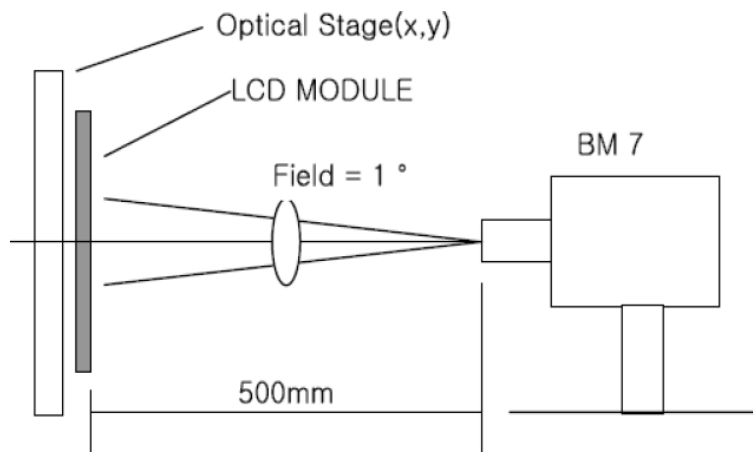

Note 2: Contrast ratio is defined as follow:

$$\text{Contrast Ratio} = \frac{\text{Surface Luminance with all white pixels}}{\text{Surface Luminance with all black pixels}}$$

Note 3: Response time is defined as follow:

Response time is the time required for the display to transition from black to white (Rise Time, T_r) and from white to black(Decay Time, T_f).

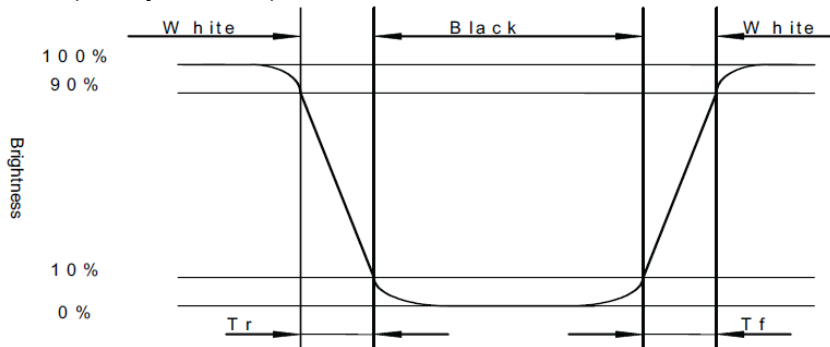

Note 4: Viewing angle range is defined as follow:

Viewing angle is measured at the center point of the LCD.

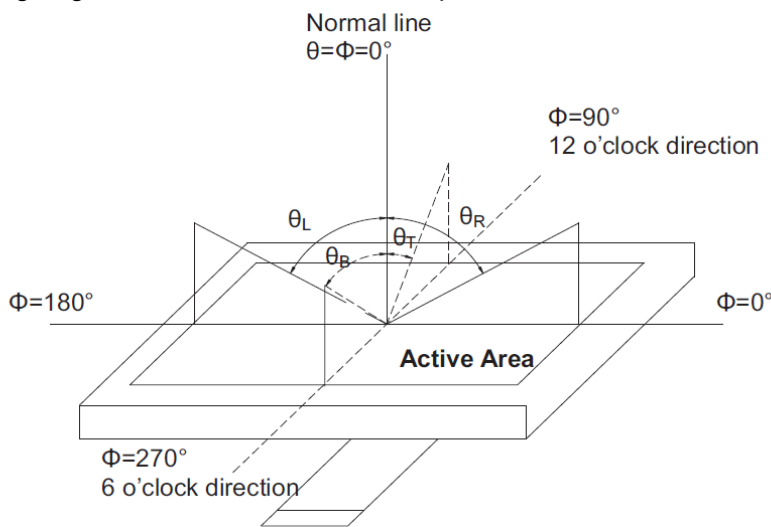

Note 5: Color chromaticity is defined as follow: (CIE1931)

Color coordinates measured at center point of LCD.

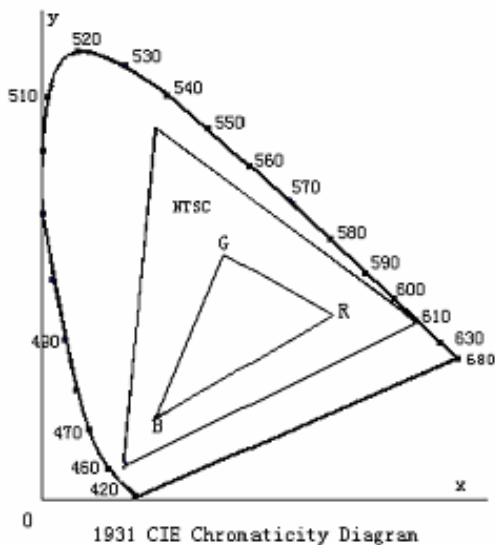

$$S = \frac{\text{area of RGB triangle}}{\text{area of NTSC triangle}} \times 100\%$$

Note 6: Luminance is defined as follow:

Luminance is defined as the brightness of all pixels “White” at the center of display area on optimum contrast.

Note 7: Luminance Uniformity is defined as follow:

Active area is divided into 9 measuring areas (Refer Fig. 2). Every measuring point is placed at the center of each measuring area.

$$\text{Uniformity}(U) = \frac{\text{Minimum Luminance(brightness) in 9 points}}{\text{Maximum Luminance(brightness) in 9 points}}$$

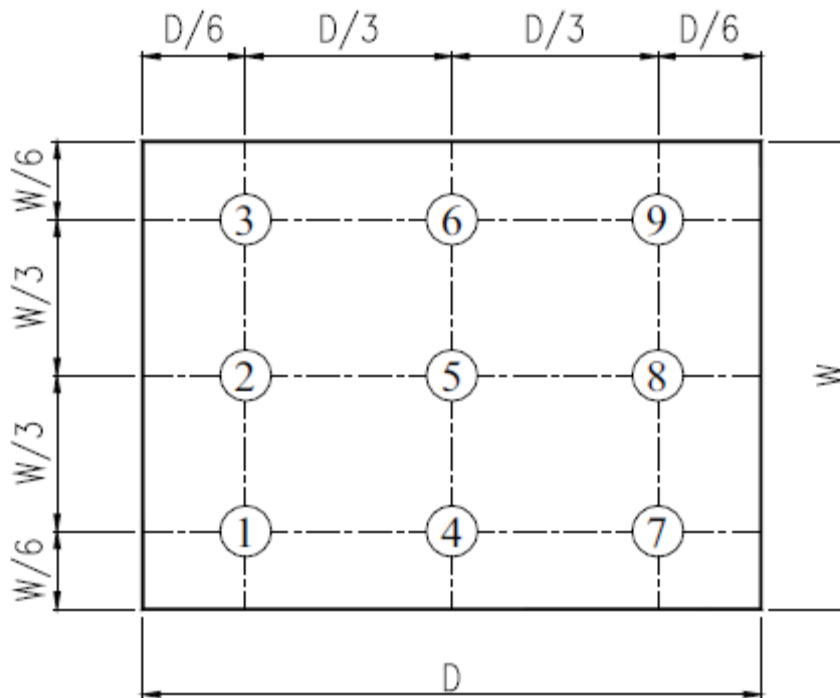

Fig. 2 Definition of uniformity

10. Environmental / Reliability Tests

No	Test Item	Condition	Judgment criteria
1	High Temp Operation	Ts=+70°C, 120hrs	Per table in below
2	Low Temp Operation	Ta=-20°C, 120hrs	Per table in below
3	High Temp Storage	Ta=+80°C, 120hrs	Per table in below
4	Low Temp Storage	Ta=-30°C, 120hrs	Per table in below
5	High Temp & High Humidity Storage	Ta=+80°C, 90% RH 120 hours	Per table in below (polarizer discoloration is excluded)
6	Thermal Shock (Non-operation)	-30°C 30 min~+80°C 30 min, Change time:5min, 10 Cycles	Per table in below
7	ESD (Operation)	C=150pF, R=330Ω□5points/panel Air:±8KV, 5times; Contact:±4KV, 5 times;	Per table in below
8	Vibration (Non-operation)	Frequency range:10~55Hz, Stroke:1.5mm Sweep:10Hz~55Hz~10Hz 2 hours for each direction of X.Y.Z.	Per table in below
9	Shock (Non-operation)	60G 6ms, ±X,±Y,±Z 3times, for each direction	Per table in below
10	Package Drop Test	Height:80 cm, 1 corner, 3 edges, 6 surfaces	Per table in below

INSPECTION	CRITERION(after test)
Appearance	No Crack on the FPC, on the LCD Panel
Alignment of LCD Panel	No Bubbles in the LCD Panel No other Defects of Alignment in Active area
Electrical current	Within device specifications
Function / Display	No Broken Circuit, No Short Circuit or No Black line No Other Defects of Display

11. Precautions for Use of LCD Modules

11.1 Safety

The liquid crystal in the LCD is poisonous. Do not put it in your mouth. If the liquid crystal touches your skin or clothes, wash it off immediately using soap and water.

11.2 Handling

A. The LCD and touch panel is made of plate glass. Do not subject the panel to mechanical shock or to excessive force on its surface.

B. Do not handle the product by holding the flexible pattern portion in order to assure the reliability

C. Transparency is an important factor for the touch panel. Please wear clear finger sacks, gloves and mask to protect the touch panel from finger print or stain and also hold the portion outside the view area when handling the touch panel.

D. Provide a space so that the panel does not come into contact with other components.

E. To protect the product from external force, put a covering lens (acrylic board or similar board) and keep an appropriate gap between them.

F. Transparent electrodes may be disconnected if the panel is used under environmental conditions where dew condensation occurs.

G. Property of semiconductor devices may be affected when they are exposed to light, possibly resulting in IC malfunctions.

H. To prevent such IC malfunctions, your design and mounting layout shall be done in the way that the IC is not exposed to light in actual use.

11.3 Static Electricity

A. Ground soldering iron tips, tools and testers when they are in operation.

B. Ground your body when handling the products.

C. Power on the LCD module before applying the voltage to the input terminals.

D. Do not apply voltage which exceeds the absolute maximum rating.

E. Store the products in an anti-electrostatic bag or container.

11.4 Storage

A. Store the products in a dark place at $+25^{\circ}\text{C} \pm 10^{\circ}\text{C}$ with low humidity (40% RH to 60% RH). Don't expose to sunlight or fluorescent light.

B. Storage in a clean environment, free from dust, active gas, and solvent.

11.5 Cleaning

A. Do not wipe the touch panel with dry cloth, as it may cause scratch.

B. Wipe off the stain on the product by using soft cloth moistened with ethanol. Do not allow ethanol to get in between the upper film and the bottom glass. It may cause peeling issue or defective operation. Do not use any organic solvent or detergent other than ethanol.

11.6 Cautions for installing and assembling

Bezel edge must be positioned in the area between the Active area and View area. The bezel may press the touch screen and cause activation if the edge touches the active area. A gap of approximately 0.5mm is needed between the bezel and the top electrode. It may cause unexpected activation if the gap is too narrow. There is a tolerance of 0.2 to 0.3mm for the outside dimensions of the touch panel and tail. A gap must be made to absorb the tolerance in the case and connector.

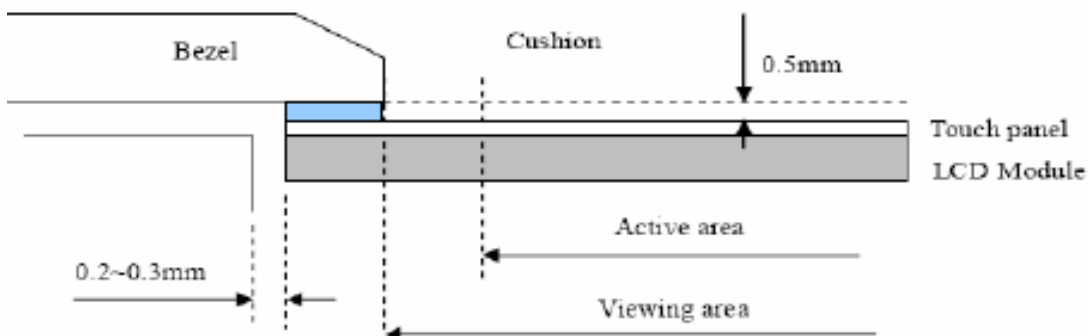

X-ON Electronics

Largest Supplier of Electrical and Electronic Components

Click to view similar products for [TFT Displays & Accessories category](#):

Click to view products by [Microtips manufacturer](#):

Other Similar products are found below :

[F3ET2-005-150](#) [HDA430T-3G1H](#) [NL6448BC20-21D](#) [NB7W-KBA04](#) [NB-ATT01](#) [NB5Q-ATT01](#) [NB5Q-KBA04](#) [NB-CN001](#) [OAI-80038AA-2008-A](#) [315-U004B15300](#) [UMSH-8596MD-34T \(REV D\)](#) [TCG121WXLRXVNNANX35](#) [EIC-LCD-1080P](#) [T-55619GD065J-LW-ABN](#) [TCG104SVLPEANN-AN30](#) [NL6448BC33-70](#) [NL6448BC20-30D](#) [NL10276BC16-06](#) [NL192108AC10-01D](#) [NL12880BC20-05BD](#) [NL8060BC26-35BA](#) [NL8060BC31-50F](#) [TM070DDHG03-40](#) [NL10276AC30-42C](#) [PTPW16-070WV1S02](#) [PTPW17-070WV1S02](#) [PTPW16-084SV1S02](#) [MTD0300ECP06DF-1](#) [DEM 320240T VMX-PW-N \(A-TOUCH\)](#) [DEM 480128B TMH-PW-N \(A-TOUCH\)](#) [DEM 480272P VMX-PW-N \(C-TOUCH\)](#) [DEM 480272Q VMX-PW-N \(A-TOUCH\)](#) [DEM 480272Q VMX-PW-N \(C-TOUCH\)](#) [DEM 640480E TMH-PW-N \(A-TOUCH\)](#) [DEM 800480K1 TMH-PW-N \(A-TOUCH\)](#) [DEM 800480K1 TMH-PW-N \(C-TOUCH\)](#) [DEM 800480K2 TMH-PW-N \(A-TOUCH\)](#) [DEM 800480K3 TMH-PW-N \(C-TOUCH\)](#) [DEM 800480K4 TMH-PW-N \(A-TOUCH\)](#) [DEM 800480K4 TMH-PW-N \(C-TOUCH\)](#) [4DLCD-35480320-CTP-IPS](#) [4DLCD-35480320-IPS](#) [4DLCD-35480320-RTP-IPS](#) [4DLCD-50800480-CTP-IPS](#) [RFA6400E-AWH-DNG](#) [RFA6400E-AWH-MNN](#) [RFE430V-AZW-DNS](#) [RFF70VA2-1IW-DHS](#) [RFH700A8-AYH-MNN](#) [RFK101VF-1YH-LHG](#)