

The logo consists of three vertical bars of varying heights and colors: red, green, and blue. To the right of these bars is the word "Microtips" in a large, bold, serif font. Below "Microtips" is a thick horizontal line, and underneath that line, the word "TECHNOLOGY" is written in a smaller, all-caps, serif font.

Microtips
TECHNOLOGY

Model No: MVÖFÍ Î €ÔZŠ

TEL: 1-888-499-TIPS (8477)

FAX: (407) 273-0771

E-MAIL: mtusainfo@microtipsusa.com

WEB:www.microtipsusa.com

Record of Revision

Date	Revision No.	Summary
2017-04-20	1.0	Rev 1.0 was issued

1. Scope

This data sheet is to introduce the specification of **MTD1560CZL** active matrix TFT module. It is composed of a color TFT-LCD panel, driver ICs, FPC, backlight unit and a conversion board. The 15.6” display area contains 1920(RGB) x 1080 pixels.

2. Application

Digital equipments which need color display, monitor and laptop.

3. General Information

Item	Contents	Unit
Size	15.60	inch
Resolution	1920(RGB) x 1080	/
Interface	LVDS	/
Technology type	a-Si TFT	/
Pixel pitch	0.17925 x 0.17925	mm
Pixel Configuration	RGB vertical stripe	
Outline Dimension (W x H x D)	359.5 x 223.8 x 3.2	mm
Active Area	344.16 x 193.59	mm
Display Mode	Transmissive, Normally Black	/
Backlight Type	LED	/
Weight	TBD	g

4. Outline Drawing

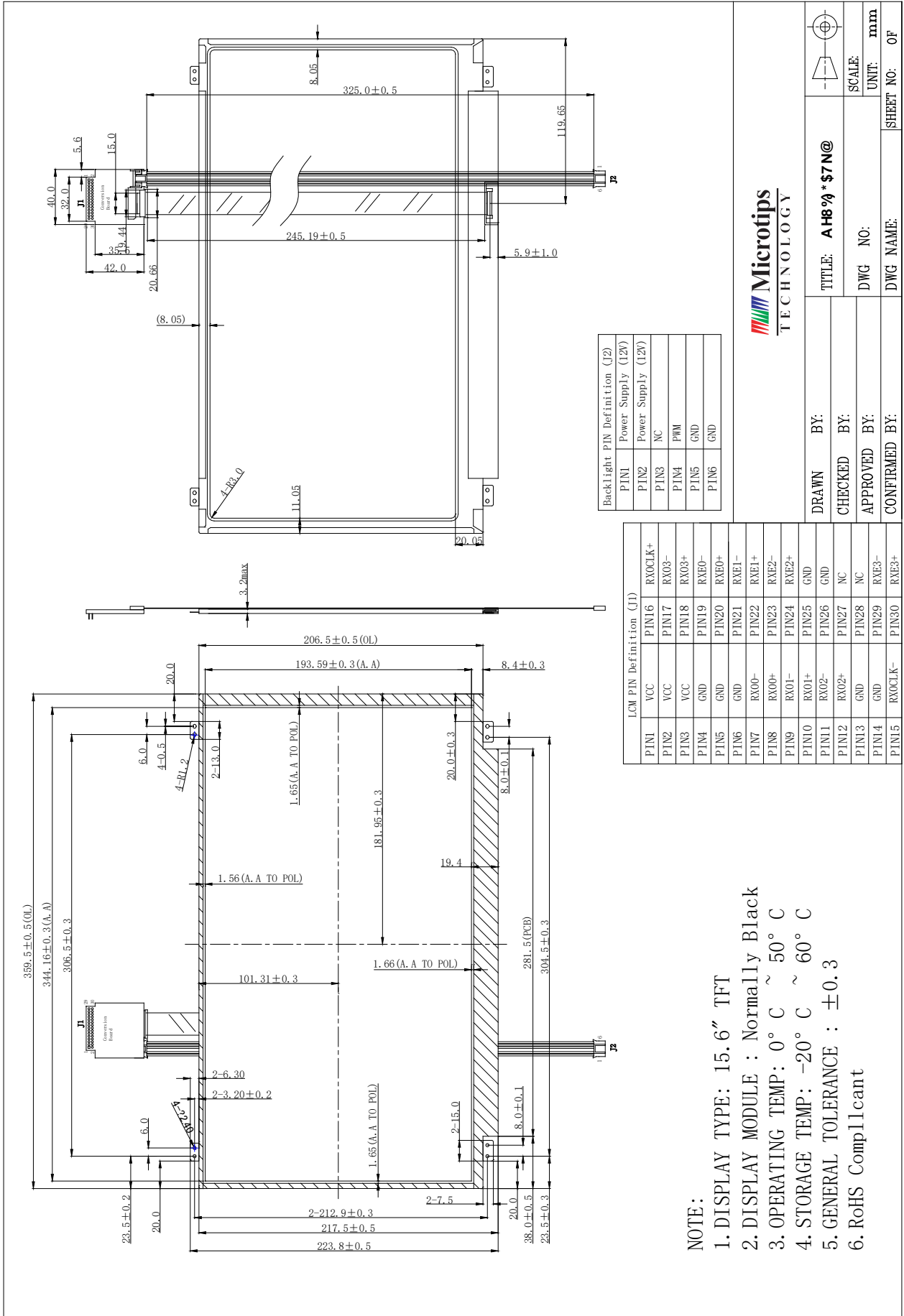

5. Interface signals

J1 (LVDS signals)

Pin No	Symbol	I/O	Funktion	Remark
1	VCC	P	Power Supply	
2	VCC	P	Power Supply	
3	VCC	P	Power Supply	
4	GND	P	Ground	
5	GND	P	Ground	
6	GND	P	Ground	
7	RX00-	I	-LVDS differential data input (ODD)	
8	RX00+	I	+LVDS differential data input (ODD)	
9	RX01-	I	-LVDS differential data input (ODD)	
10	RX01+	I	+LVDS differential data input (ODD)	
11	RX02-	I	-LVDS differential data input (ODD)	
12	RX02+	I	+LVDS differential data input (ODD)	
13	GND	P	Ground	
14	GND	P	Ground	
15	RX0CLK-	I	-LVDS differential clock input	
16	RX0CLK+	I	-LVDS differential clock input	
17	RX03-	I	-LVDS differential data input (ODD)	
18	RX03+	I	+LVDS differential data input (ODD)	
19	RXE0-	I	-LVDS differential data input (EVEN)	
20	RXE0+	I	+LVDS differential data input (EVEN)	
21	RXE1-	I	-LVDS differential data input (EVEN)	
22	RXE1+	I	+LVDS differential data input (EVEN)	
23	RXE2-	I	-LVDS differential data input (EVEN)	
24	RXE2+	I	+LVDS differential data input (EVEN)	
25	GND	P	Ground	
26	GND	P	Ground	
27	NC	-	No connection	
28	NC	-	No connection	
29	RXE3-	I	-LVDS differential data input (EVEN)	
30	RXE3+	I	+LVDS differential data input (EVEN)	

P: POWER I: Input O: Output

J2 (Backlight power supply)

Pin No	Symbol	Funktion
1	Power supply	Power Supply (12v)
2	Power supply	Power Supply (12v)
3	NC	No connection
4	PWM	PWM signal to control the brightness
5	GND	Ground
6	GND	Ground

6. Absolute maximum Ratings

6.1. Electrical Absolute max. ratings

Parameter	Symbol	MIN	MAX	Unit	Remark
Power Supply Voltage	VCC	-0.3	+4.0	V	

Notes : "Absolute Maximum Ratings" is regulations that do not exceed it even momentarily. Stress beyond those listed under "Absolute Maximum Ratings" may cause permanent damage to the device.

6.2. Environment Conditions

Item	Symbol	MIN	MAX	Unit	Remark
Operating Temperature	TOPR	0	+50	°C	
Storage Temperature	TSTG	-20	+60	°C	

Note : Temperature and relative humidity range are shown in the figure below.

95 % RH Max. ($40\text{ }^{\circ}\text{C} \geq T_a$)

Maximum wet -bulb temperature at $39\text{ }^{\circ}\text{C}$ or less. ($T_a > 40\text{ }^{\circ}\text{C}$) No condensation.

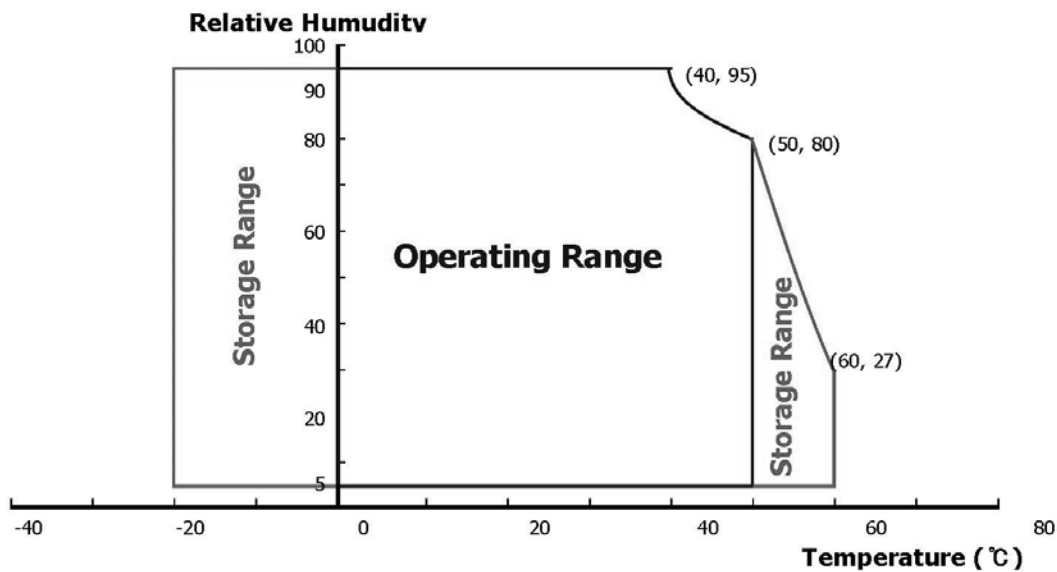

7. Electrical Specifications

7.1 Electrical characteristics

Ta=+25°C

Parameter	Symbol	Value			Unit	Remark
		Min.	Typ.	Max.		
Power Supply Voltage	VCC	3.0	3.3	3.6	V	

7.2 Black Unit

The backlight system is an edge-lighting type with white-LED.

Parameter	Symbol	Min.	Typ	Max.	Unit	Remark
Supply voltage	VBL	7.0	12.0	21.0	V	
Current dissipation	IBL	-	180		mA	VBL =12.0V Duty Ratio =100%
Modulated light signal voltage	VPWMH	1.85	-	VDD	V	
	VPWML	0	-	0.7	V	
Brightness Control Duty Ratio	Duty	1	-	100	%	Note1
Brightness Control pulse width	TPWM	5	-	-	us	Note2
Brightness Control frequency	fPWM	200	-	2000	Hz	
LED-BL ON/OFF High voltage	VCNTH	1.3	-	VDD	V	Note3
LED-BL ON/OFF Low voltage	VCNTL	0	-	0.5	V	
Input signal (H level) pin current	IIN	-	-	VIN/56KΩ	μA	BL_ENABLE, BL_PWM_DIM
LED lifetime	-	-	10000	-	h	LED

Note1: VPWM Input : 100%= Max luminance 1%= Min luminance

Note2: The minimum value of the dimming signal pulse width is assumed regulations of the width of high and the width of low.

Note3: VCNT Input : High = BL turn on, Low or OPEN =BL turn off

Note: VBL-dip conditions

1) $V_{th} \leq V_{BL} < V_{min}$: $t_d \leq 20ms$

2) $V_{BL} < V_{th}$: The condition of instantaneous voltage drop is apply to input voltage sequences

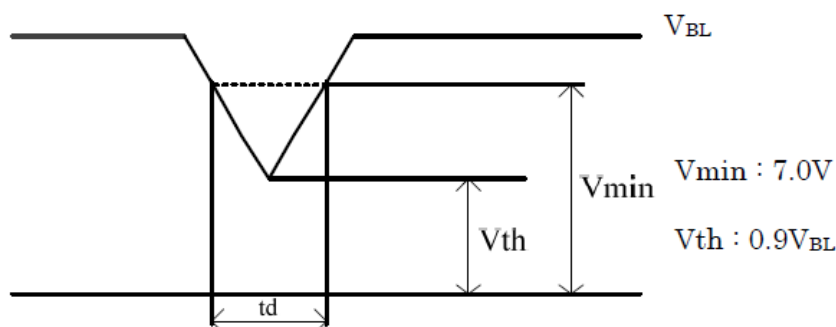

8. Command/AC Timing

8.1 Timing characteristics

Parameter		Symbol	Min.	Typ.	Max	Unit	Remark
Clock	Frequency	1/TC	132.0	138.5	140.0	MHz	Note
Data enable signal	Horizontal period	TH	2020	2080	2400	clock	
				15.02		μs	
	Horizontal period (High)	THd	-	1920	-	clock	
	Vertical period	TV	1090	1111	1200	line	
			-	16.685	-	ms	
Vertical period (High)	TVd	-	1080	-	line		

Note: In case of using the long vertical period, the deterioration of display quality, flicker, etc. may occur.

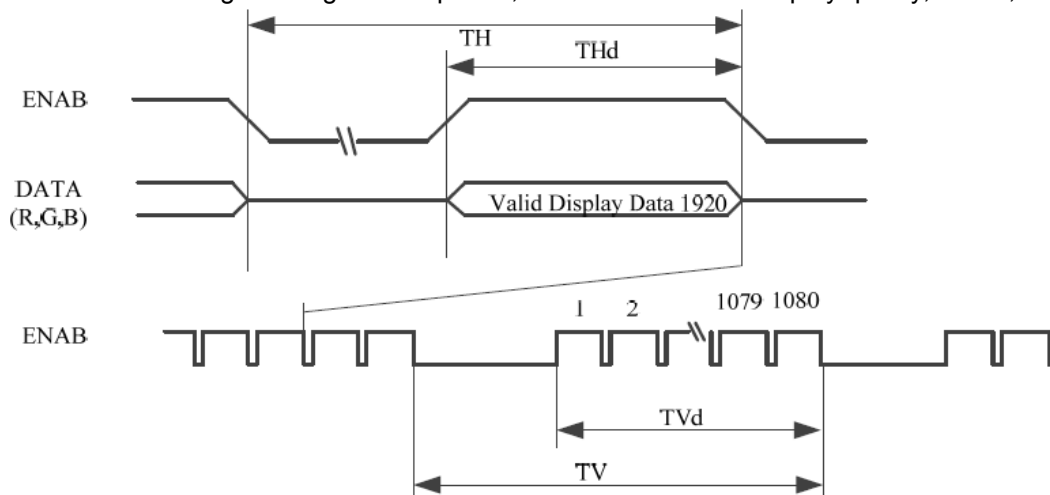

8.2 Input data signals and display position on the screen



8. 3 Input signal, basic display colors and gray scale of each color

	Colors& Gray scale	Gray scale	Data signal																	
			R0	R1	R2	R3	R4	R5	G0	G1	G2	G3	G4	G5	B0	B1	B2	B3	B4	B5
			LSB					MSB					LSB					MSB		
Basic colors	Black	-	0	0	0	0	0	0	0	0	0	0	0	0	0	0	0	0	0	0
	Blue	-	0	0	0	0	0	0	0	0	0	0	0	0	1	1	1	1	1	1
	Green	-	0	0	0	0	0	0	1	1	1	1	1	1	0	0	0	0	0	0
	Light Blue	-	0	0	0	0	0	0	1	1	1	1	1	1	1	1	1	1	1	1
	Red	-	1	1	1	1	1	1	0	0	0	0	0	0	0	0	0	0	0	0
	Purple	-	1	1	1	1	1	1	0	0	0	0	0	0	1	1	1	1	1	1
	Yellow	-	1	1	1	1	1	1	1	1	1	1	1	1	0	0	0	0	0	0
	White	-	1	1	1	1	1	1	1	1	1	1	1	1	1	1	1	1	1	1
Gray scale of Red	Black	GS0	0	0	0	0	0	0	0	0	0	0	0	0	0	0	0	0	0	0
	△ Darker	GS1	1	0	0	0	0	0	0	0	0	0	0	0	0	0	0	0	0	0
		GS2	0	1	0	0	0	0	0	0	0	0	0	0	0	0	0	0	0	0
	△ ▽ Brighter ▽	↓ ↓			↓ ↓					↓ ↓					↓ ↓					
		GS25	1	0	1	1	1	1	0	0	0	0	0	0	0	0	0	0	0	0
		GS25	0	1	1	1	1	1	0	0	0	0	0	0	0	0	0	0	0	0
	Read	GS25	1	1	1	1	1	1	0	0	0	0	0	0	0	0	0	0	0	0
Gray scale of Green	Black	GS0	0	0	0	0	0	0	0	0	0	0	0	0	0	0	0	0	0	0
	△ Darker	GS1	0	0	0	0	0	0	1	0	0	0	0	0	0	0	0	0	0	0
		GS2	0	0	0	0	0	0	0	1	0	0	0	0	0	0	0	0	0	0
	△ ▽ Brighter ▽	↓ ↓			↓ ↓					↓ ↓					↓ ↓					
		GS25	0	0	0	0	0	0	1	0	1	1	1	1	0	0	0	0	0	0
		GS25	0	0	0	0	0	0	0	1	1	1	1	1	0	0	0	0	0	0
	Green	GS25	0	0	0	0	0	0	1	1	1	1	1	1	0	0	0	0	0	0
Gray scale of Blue	Black	GS0	0	0	0	0	0	0	0	0	0	0	0	0	0	0	0	0	0	0
	△ Darker	GS1	0	0	0	0	0	0	0	0	0	0	0	0	1	0	0	0	0	0
		GS2	0	0	0	0	0	0	0	0	0	0	0	0	0	1	0	0	0	0
	△ ▽ Brighter ▽	↓ ↓			↓ ↓					↓ ↓					↓ ↓					
		GS25	0	0	0	0	0	0	1	0	1	1	1	1	0	0	0	0	0	0
		GS25	0	0	0	0	0	0	0	1	1	1	1	1	0	0	0	0	0	0
	Blue	GS25	0	0	0	0	0	0	1	1	1	1	1	1	0	0	0	0	0	0
Gray scale of White&Black	Black	GS0	0	0	0	0	0	0	0	0	0	0	0	0	0	0	0	0	0	0
	△ Darker	GS1	0	0	0	0	0	0	0	0	0	0	0	0	1	0	0	0	0	0
		GS2	0	0	0	0	0	0	0	0	0	0	0	0	0	1	0	0	0	0
	△ ▽ Brighter ▽	↓ ↓			↓ ↓					↓ ↓					↓ ↓					
		GS25	0	0	0	0	0	0	0	0	0	0	0	0	1	0	1	1	1	1
		GS25	0	0	0	0	0	0	0	0	0	0	0	0	0	1	1	1	1	1
	White	GS25	0	0	0	0	0	0	0	0	0	0	0	0	1	1	1	1	1	1

9. Optical Specification

Ta=25°C

Item	Symbol	Condition	Min	Typ.	Max.	Unit	Remark
Contrast Ratio	CR	$\theta=0^\circ$	700	1000	--		Note1 Note2
Response Time	Tr+Tf	25°C	--	25	35	ms	Note1 Note3
View Angles	θT	$CR \geq 10$	--	89	--	Degree	Note 4
	θB		--	89	--		
	θL		--	89	--		
	θR		--	89	--		
Chromaticity	White	x	Brightness is on	-	-		Note5, Note1
		y					
	Red	x					
		y					
	Green	x					
		y					
	Blue	x					
		y					
Gumat	S		--	45	--	%	
Luminance	L		--	200	--	cd/m ²	Note1 Note6
Uniformity	U		--	80	--	%	Note1 Note7

Note 1: Definition of optical measurement system.

Temperature = 25°C(±3°C);

cLED back-light: ON, Environment brightness < 150 lx

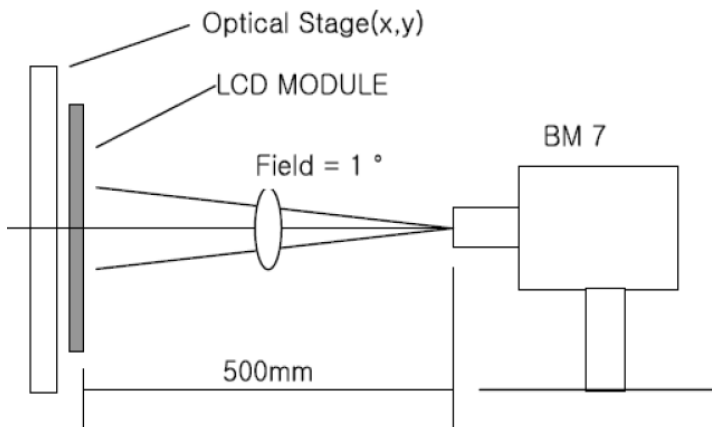

Note 2: Contrast ratio is defined as follow:

$$\text{Contrast Ratio} = \frac{\text{Surface Luminance with all white pixels}}{\text{Surface Luminance with all black pixels}}$$

Note 3: Response time is defined as follow:

Response time is the time required for the display to transition from black to white (Rise Time, T_r) and from white to black (Decay Time, T_f).

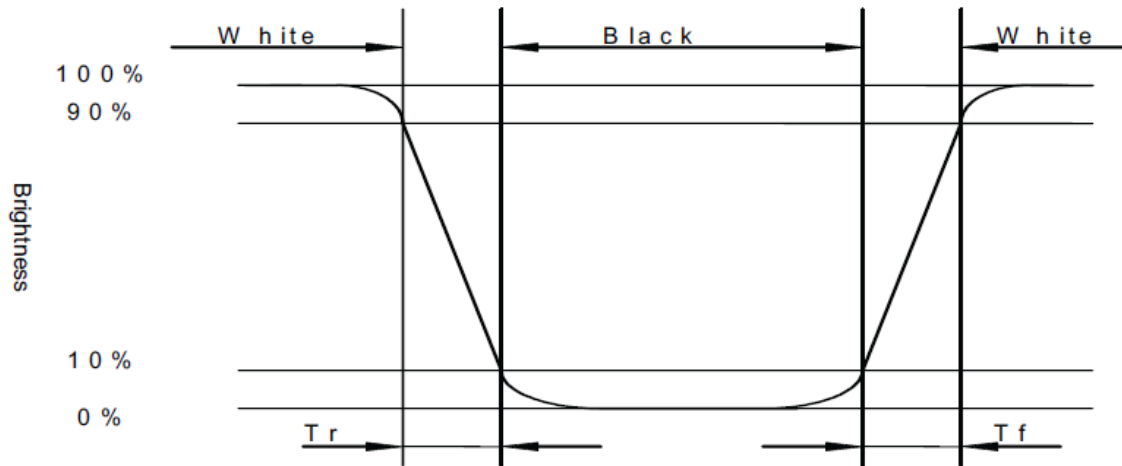

Note 4: Viewing angle range is defined as follow:

Viewing angle is measured at the center point of the LCD.

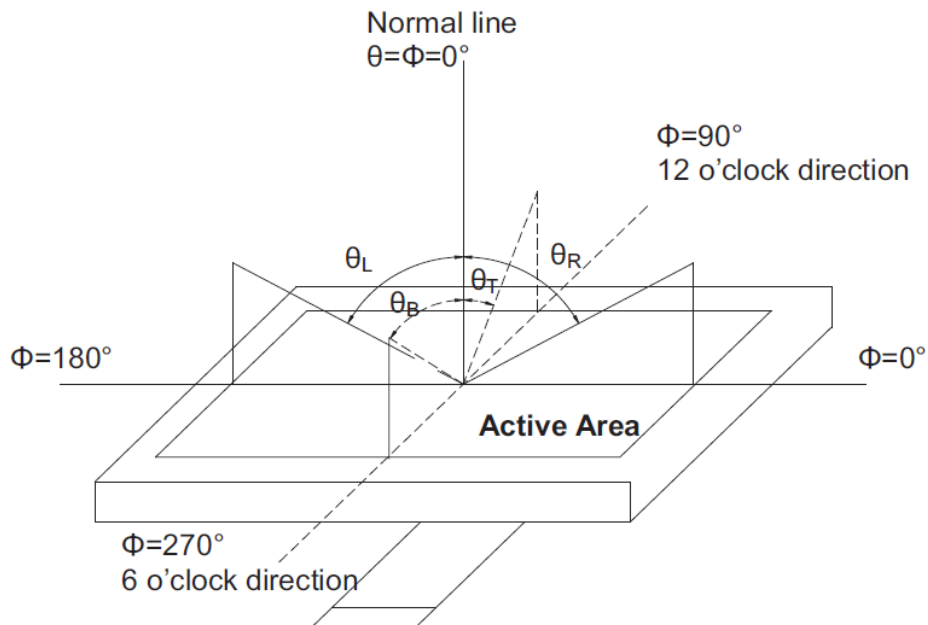

Note 5: Color chromaticity is defined as follow: (CIE1931)

Color coordinates measured at center point of LCD.

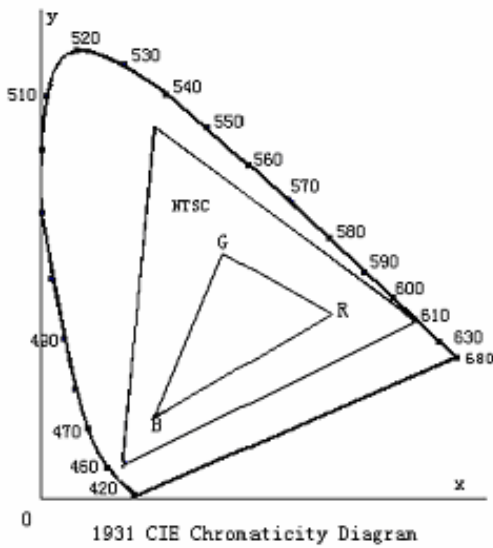

$$S = \frac{\text{area of RGB triangle}}{\text{area of NTSC triangle}} \times 100\%$$

Note 6: Luminance is defined as follow:

Luminance is defined as the brightness of all pixels “White” at the center of display area on optimum contrast.

Note 7: Luminance Uniformity is defined as follow:

Active area is divided into 9 measuring areas (Refer Fig. 2). Every measuring point is placed at the center of each measuring area.

$$\text{Uniformity}(U) = \frac{\text{Minimum Luminance(brightness) in 9 points}}{\text{Maximum Luminance(brightness) in 9 points}}$$

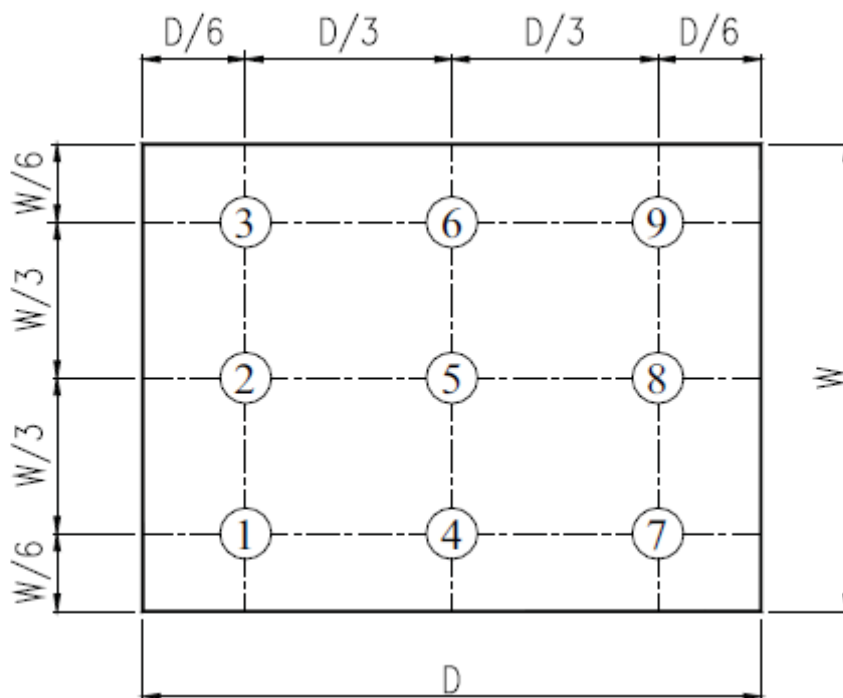

Fig. 2 Definition of uniformity

10. Environmental / Reliability Tests

No	Test Item	Condition	Judgment criteria
1	High Temp Operation	Ts=50°C, 120hrs	Per table in below
2	Low Temp Operation	Ta=0°C, 120hrs	Per table in below
3	High Temp Storage	Ta=+60°C, 120hrs	Per table in below
4	Low Temp Storage	Ta=-20°C, 120hrs	Per table in below
5	High Temp & High Humidity Storage	Ta=+50°C, 95% RH 120 hours	Per table in below (polarizer discoloration is excluded)
6	Thermal Shock (Non-operation)	-20°C 30 min~+60°C 30 min, Change time:5min, 100Cycles	Per table in below
7	ESD (Operation)	C=150pF, R=330Ω · 5points/panel Air:±15KV, 5times; Contact:±8KV, 5 times;	Per table in below
8	Vibration (Non-operation)	1.5G, 10~500Hz,Half Sine X,Y,Z / Sweep rate : 1 hour	Per table in below
9	Shock (Non-operation)	220G, Half Sine Wave 2msec ±X,±Y,±Z Once for each direction	Per table in below
10	Package Drop Test	Height:80 cm, 1 corner, 3 edges, 6 surfaces	Per table in below

INSPECTION	CRITERION(after test)
Appearance	No Crack on the FPC, on the LCD Panel
Alignment of LCD Panel	No Bubbles in the LCD Panel No other Defects of Alignment in Active area
Electrical current	Within device specifications
Function / Display	No Broken Circuit, No Short Circuit or No Black line No Other Defects of Display

11. Precautions for Use of LCD Modules

11.1 Safety

The liquid crystal in the LCD is poisonous. Do not put it in your mouth. If the liquid crystal touches your skin or clothes, wash it off immediately using soap and water.

11.2 Handling

A. The LCD and touch panel is made of plate glass. Do not subject the panel to mechanical shock or to excessive force on its surface.

B. Do not handle the product by holding the flexible pattern portion in order to assure the reliability

C. Transparency is an important factor for the touch panel. Please wear clear finger sacks, gloves and mask to protect the touch panel from finger print or stain and also hold the portion outside the view area when handling the touch panel.

D. Provide a space so that the panel does not come into contact with other components.

E. To protect the product from external force, put a covering lens (acrylic board or similar board) and keep an appropriate gap between them.

F. Transparent electrodes may be disconnected if the panel is used under environmental conditions where dew condensation occurs.

G. Property of semiconductor devices may be affected when they are exposed to light, possibly resulting in IC malfunctions.

H. To prevent such IC malfunctions, your design and mounting layout shall be done in the way that the IC is not exposed to light in actual use.

11.3 Static Electricity

A. Ground soldering iron tips, tools and testers when they are in operation.

B. Ground your body when handling the products.

C. Power on the LCD module before applying the voltage to the input terminals.

D. Do not apply voltage which exceeds the absolute maximum rating.

E. Store the products in an anti-electrostatic bag or container.

F. Peel off the LCM protective film slowly since static electricity may be generated.

11.4 Storage

A. Store the products in a dark place at $+25^{\circ}\text{C} \pm 10^{\circ}\text{C}$ with low humidity (40% RH to 60% RH). Don't expose to sunlight or fluorescent light.

B. Storage in a clean environment, free from dust, active gas, and solvent.

11.5 Cleaning

A. Do not wipe the touch panel with dry cloth, as it may cause scratch.

B. Wipe off the stain on the product by using soft cloth moistened with ethanol. Do not allow ethanol to get in between the upper film and the bottom glass. It may cause peeling issue or defective operation. Do not use any organic solvent or detergent other than ethanol.

11.6 Cautions for installing and assembling

Bezel edge must be positioned in the area between the Active area and View area. The bezel may press the touch screen and cause activation if the edge touches the active area. A gap of approximately 0.5mm is needed between the bezel and the top electrode. It may cause unexpected activation if the gap is too narrow. There is a tolerance of 0.2 to 0.3mm for the outside dimensions of the touch panel and tail. A gap must be made to absorb the tolerance in the case and connector.

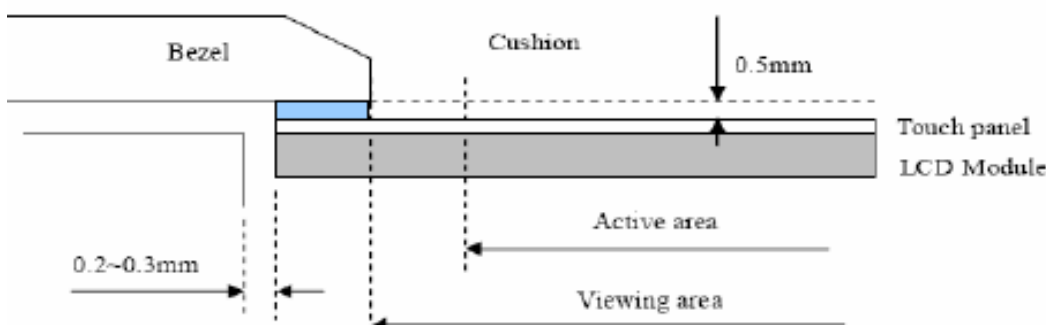

X-ON Electronics

Largest Supplier of Electrical and Electronic Components

Click to view similar products for [TFT Displays & Accessories](#) category:

Click to view products by [Microtips](#) manufacturer:

Other Similar products are found below :

[F3ET2-005-150](#) [HDA430T-3G1H](#) [NL6448BC20-21D](#) [NB7W-KBA04](#) [NB-ATT01](#) [NB5Q-ATT01](#) [NB5Q-KBA04](#) [NB-CN001](#) [OAI-80038AA-2008-A](#) [315-U004B15300](#) [UMSH-8596MD-34T \(REV D\)](#) [TCG121WXLRXVNNANX35](#) [EIC-LCD-1080P](#) [T-55619GD065J-LW-ABN](#) [TCG104SVLPEANN-AN30](#) [NL6448BC33-70](#) [NL6448BC20-30D](#) [NL10276BC16-06](#) [NL192108AC10-01D](#) [NL12880BC20-05BD](#) [NL8060BC26-35BA](#) [NL8060BC31-50F](#) [TM070DDHG03-40](#) [NL10276AC30-42C](#) [PTPW16-070WV1S02](#) [PTPW17-070WV1S02](#) [PTPW16-084SV1S02](#) [MTD0300ECP06DF-1](#) [DEM 320240T VMX-PW-N \(A-TOUCH\)](#) [DEM 480128B TMH-PW-N \(A-TOUCH\)](#) [DEM 480272P VMX-PW-N \(C-TOUCH\)](#) [DEM 480272Q VMX-PW-N \(A-TOUCH\)](#) [DEM 480272Q VMX-PW-N \(C-TOUCH\)](#) [DEM 640480E TMH-PW-N \(A-TOUCH\)](#) [DEM 800480K1 TMH-PW-N \(A-TOUCH\)](#) [DEM 800480K1 TMH-PW-N \(C-TOUCH\)](#) [DEM 800480K2 TMH-PW-N \(A-TOUCH\)](#) [DEM 800480K3 TMH-PW-N \(C-TOUCH\)](#) [DEM 800480K4 TMH-PW-N \(A-TOUCH\)](#) [DEM 800480K4 TMH-PW-N \(C-TOUCH\)](#) [4DLCD-35480320-CTP-IPS](#) [4DLCD-35480320-IPS](#) [4DLCD-35480320-RTP-IPS](#) [4DLCD-50800480-CTP-IPS](#) [RFA6400E-AWH-DNG](#) [RFA6400E-AWH-MNN](#) [RFE430V-AZW-DNS](#) [RFF70VA2-1IW-DHS](#) [RFH700A8-AYH-MNN](#) [RFK101VF-1YH-LHG](#)