

MCT010A0W12896LMLIPS	128 x 96	SPI Interface	TFT Module
Specification			
Version: 2		Date: 09/04/2018	
Revision			
1	07/04/2017	First Issue.	
2	21/08/2017	Add Luminance and Uniformity.	

Display Features			
Display Size	1.0"		
Resolution	128 x 96		
VGA Size	N/A		
Orientation	Landscape		
Appearance	RGB		
Logic Voltage	2.8V		
Interface	4-Line SPI		
Brightness	200 cd/m ²		
Touchscreen	N/A		
Module Size	23.75 x 23.15 x 11.70 mm		
Operating Temperature	-20°C ~ +70°C		
Pinout	21 - Way FFC	Box Quantity	Weight / Display
		---	---

Display Accessories	
Part Number	Description
LEDV3	Constant current LED back light driver.

Optional Variants	
Appearances	Voltage



1. Scope

This data sheet is to introduce the specification of MCT0010A0W12896LMLIPS active matrix TFT module. It is composed of a color TFT-LCD panel, driver IC, FPC and a backlight unit. The 1.0" display area contains 128(RGB) x 96 pixels.

2. Application

Digital equipments which need color display, mobile phone, mobile navigator/video systems.

3. General Information

Item	Contents	Unit
Size	1.0	inch
Resolution	128(RGB) x 96	/
Interface	4-line SPI	/
Technology type	IPS	/
Pixel Configuration	R.G.B. Vertical Stripe	
Pixel pitch	0.154(H) x 0.154(V)	
Outline Dimension (W x H x D)	23.75 x 23.15 x 1.7	mm
Active Area	20.35 x 15.26	mm
Display Mode	Transmissive, Normally Black	/
Backlight Type	LED	/
Driver IC	ST7735S	/
Weight	TBD	g

design • manufacture • supply



4. Outline Drawing

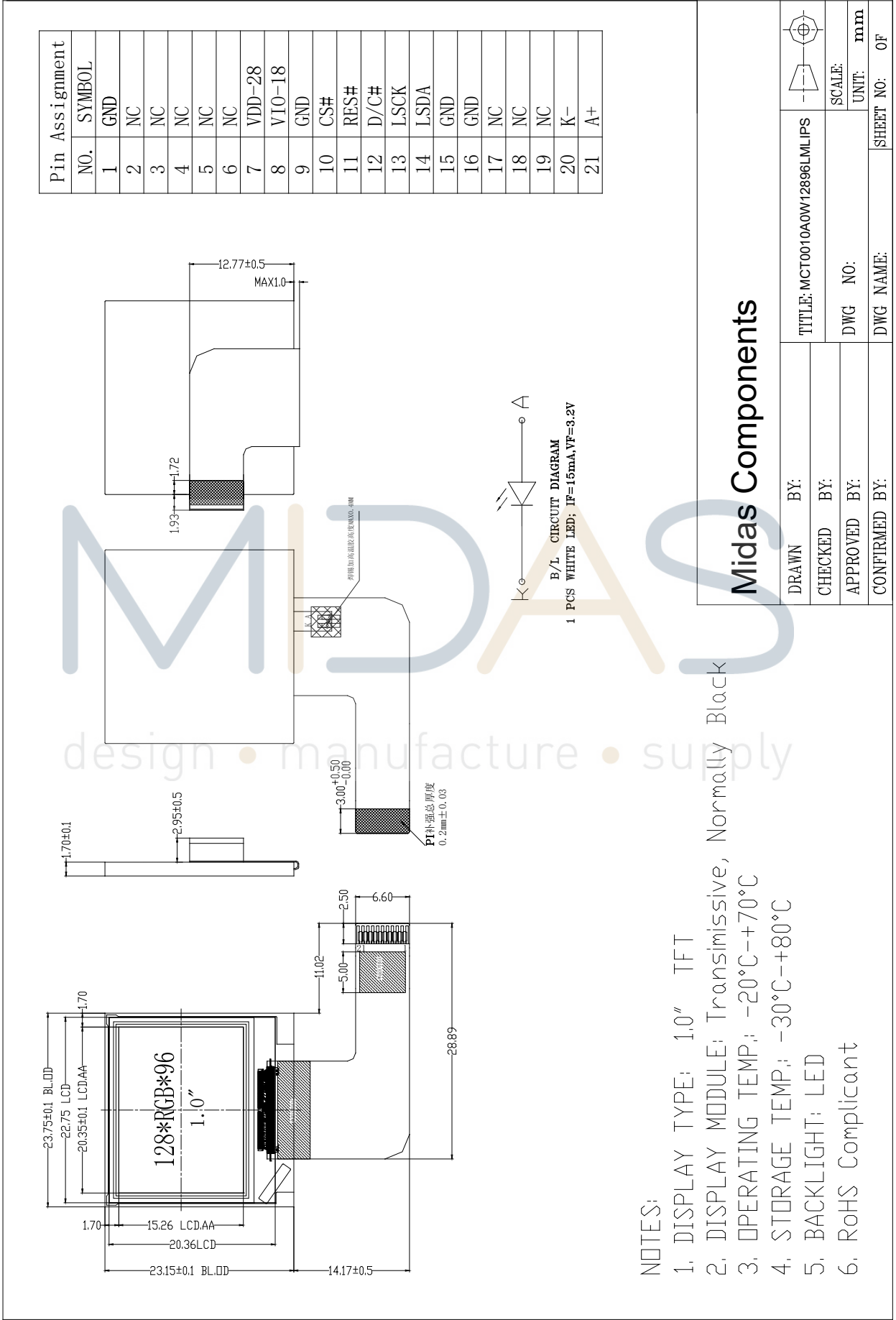

5. Interface signals

No	Symbol	Description	Remark
1	GND	Ground	
2	NC	No Connection	
3	NC	No Connection	
4	NC	No Connection	
5	NC	No Connection	
6	NC	No Connection	
7	VDD-28	Power Supply for Analog, Digital System and Booster Circuit (2.8V)	
8	VIO-18	Power Supply for I/O System (1.8V/2.8V)	
9	GND	Ground	
10	CS#	Chip select	
11	RES#	LCM Reset	
12	D/C#	Data or Command select	
13	LSCK	In Serial Interface, this is used as SCL	
14	LSDA	Serial input/output signal	
15	GND	Ground	
16	GND	Ground	
17	NC	No Connection	
18	NC	No Connection	
19	NC	No Connection	
20	K-	Backlight cathode	
21	A+	Backlight anode	

6. Absolute maximum Ratings

6.1. Electrical Absolute max. ratings

Parameter	Symbol	MIN	MAX	Unit	Remark
Power Supply Voltage	VDD	-0.3	3.3	V	

Notes:

1. $VDD \geq GND$ must be maintained.
2. The modules may be destroyed if they are used beyond the absolute maximum ratings.

6.2. Environment Conditions

Item	Symbol	MIN	MAX	Unit	Remark
Operating Temperature	TOPR	-20	70	°C	
Storage Temperature	TSTG	-30	80	°C	



7. Electrical Specifications

7.1 Electrical characteristics

VDD=IOVDD=2.6V to 3.3V, GND=0V, Ta=25°C

Parameter	Symbol	Min	Typ	Max	Unit	Remark
Supply voltage	VDD-GND	2.6	2.8	3.3	V	-
Supply current	IDD	-	6	-	mA	VDD=2.8V

7.2 LED Backlight

Ta=25°C

Item	Symbol	MIN	TYP	MAX	Unit	Remark
Forward Current	IF	-	15	-	mA	For One LED
Forward Voltage	VF	3.0	3.2	3.4	V	For One LED
Number of LED	-	-	1	-	Piece	

MIDAS
design • manufacture • supply



8. Command/AC Timing

8.1 Timing characteristics

Serial Interface Timing Characteristics (4-line serial)

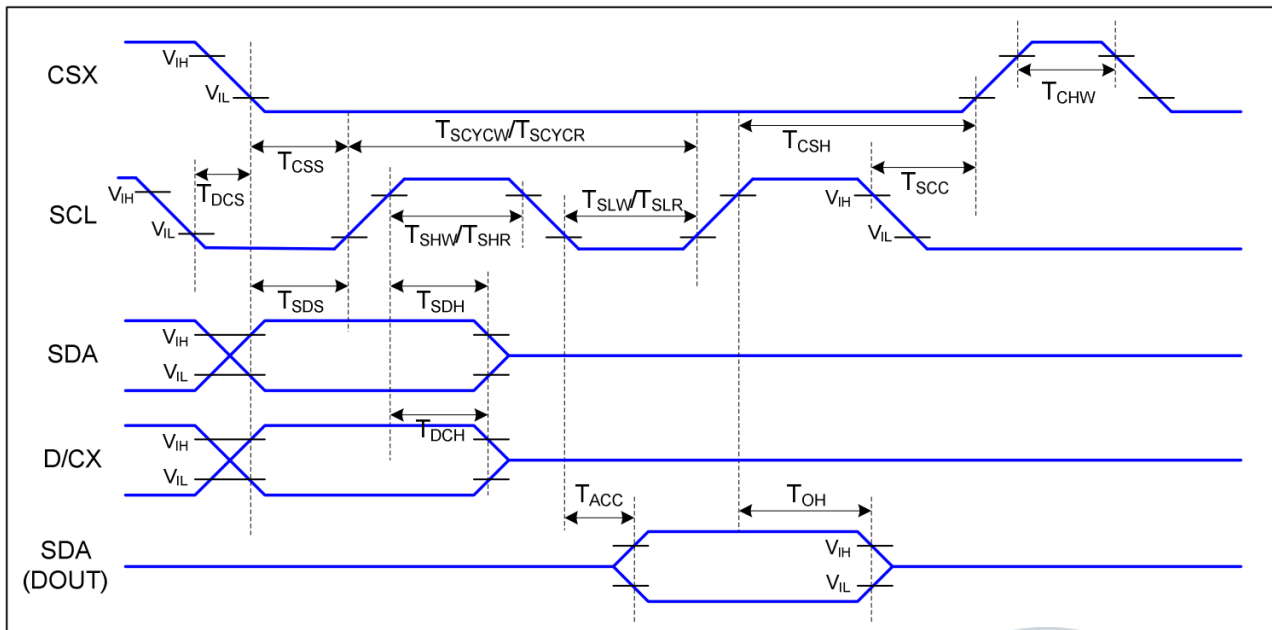

Signal	Symbol	Parameter	Min	Max	Unit	Description
CSX	TCSS	Chip select setup time (Write)	15		ns	
	TCSH	Chip select hold time (Write)	15		ns	
	TCSS	Chip select setup time (Read)	60		ns	
	TSCC	Chip select hold time (Read)	65		ns	
	TCHW	Chip select "H" pulse width	40		ns	
SCL	TSCYCW	Serial clock cycle (Write)	66		ns	
	TSHW	SCL "H" pulse width (Write)	30		ns	
	TSLW	SCL "L" pulse width (Write)	30		ns	
	TSCYCR	Serial clock cycle (Read)	150		ns	
	TSHR	SCL "H" pulse width (Read)	60		ns	
	TSLR	SCL "L" pulse width (Read)	60		ns	
D/CX	TDCS	D/CX setup time		0	ns	
	TDCH	D/CX hold time	10		ns	
SDA (DIN) (DOUT)	TSDS	Data setup time	10		ns	
	TSDH	Data hold time	10		ns	
	TACC	Access time	10	50	ns	
	TOH	Output disable time		50	ns	

8.2 Reset Input Timing

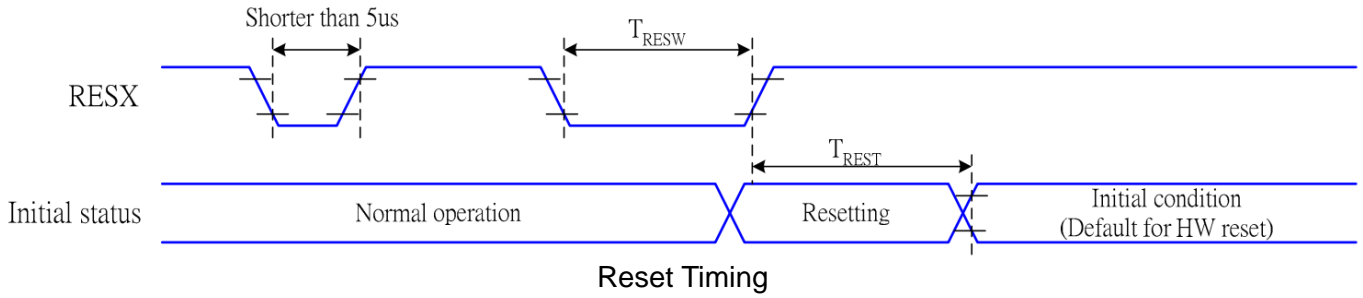

Related Pins	Symbol	Parameter	Min	Max	Unit
RESX	tRESW	Reset pulse duration	10	-	us
	tREST	Reset cancel	-	5	ms
				120	ms

Notes :

- The reset cancel includes also required time for loading ID bytes, VCOM setting and other settings from EEPROM (or similar device) to registers. This loading is done every time when there is HW reset cancel time (tRT) within 5 ms after a rising edge of RESX.
- Spike due to an electrostatic discharge on RESX line does not cause irregular system reset according to the table below:

RESX Pulse	Action
Shorter than 5 us	Reset Rejected
Longer than 9 us	Reset
Between 5 us and 9 us	Reset starts

- During the Resetting period, the display will be blanked (The display is entering blanking sequence, which maximum time is 120 ms, when Reset Starts in Sleep Out –mode. The display remains the blank state in Sleep In -mode.) and then return to Default condition for Hardware Reset.
- Spike Rejection also applies during a valid reset pulse as shown below:

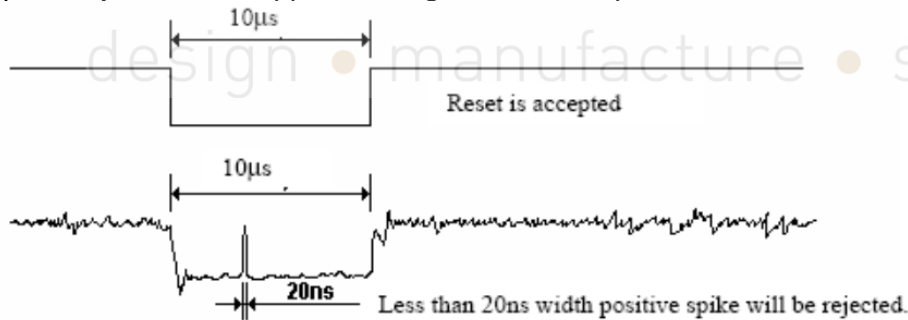

- When Reset applied during Sleep In Mode.
- When Reset applied during Sleep Out Mode.
- It is necessary to wait 5msec after releasing RESX before sending commands. Also Sleep Out command cannot be sent for 120msec.

9. Optical Specification

Ta=25°C

Item	Symbol	Condition	Min	Typ.	Max.	Unit	Remark
Contrast Ratio	CR	$\theta=0^\circ$	750	900	-		Note1 Note2
Response Time	Tr	25°C	-	30	-	ms	Note1
	Tf		-	30	-	ms	Note3
View Angles	θT	$CR \geq 10$	-	85	-	Degree	Note 4
	θB		-	85	-		
	θL		-	85	-		
	θR		-	85	-		
Chromaticity	White	x	-	0.296	-	Note5, Note1	
		y	-	0.324	-		
	Red	x	-	0.626	-		
		y	Brightness is on	-	0.310		-
	Green	x	-	0.296	-		
		y	-	0.518	-		
	Blue	x	-	0.144	-		
		y	-	0.139	-		
NTSC	S		--	50	--	%	Note5
Luminance	L		--	200	--	cd/m ²	Note1 Note6
Uniformity	U		--	80	--	%	Note1 Note7

Note 1: Definition of optical measurement system.

Temperature = 25°C(±3°C); LED back-light: ON, Environment brightness < 150 lx

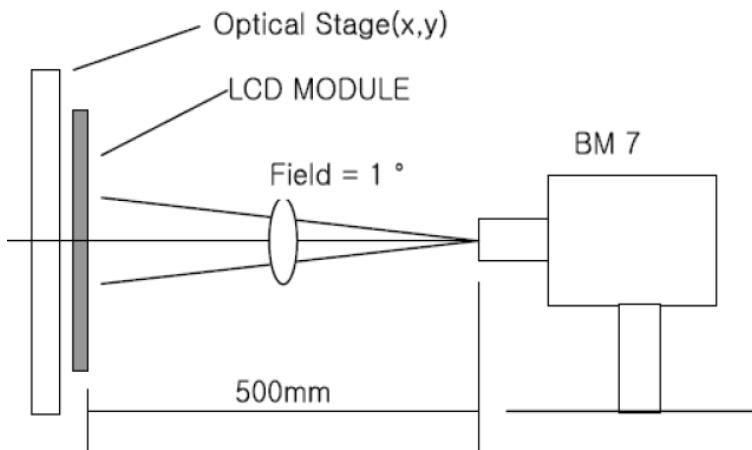

Note 2: Contrast ratio is defined as follow:

$$\text{Contrast Ratio} = \frac{\text{Surface Luminance with all white pixels}}{\text{Surface Luminance with all black pixels}}$$

Note 3: Response time is defined as follow:

Response time is the time required for the display to transition from black to white (Rise Time, T_r) and from white to black (Decay Time, T_f).

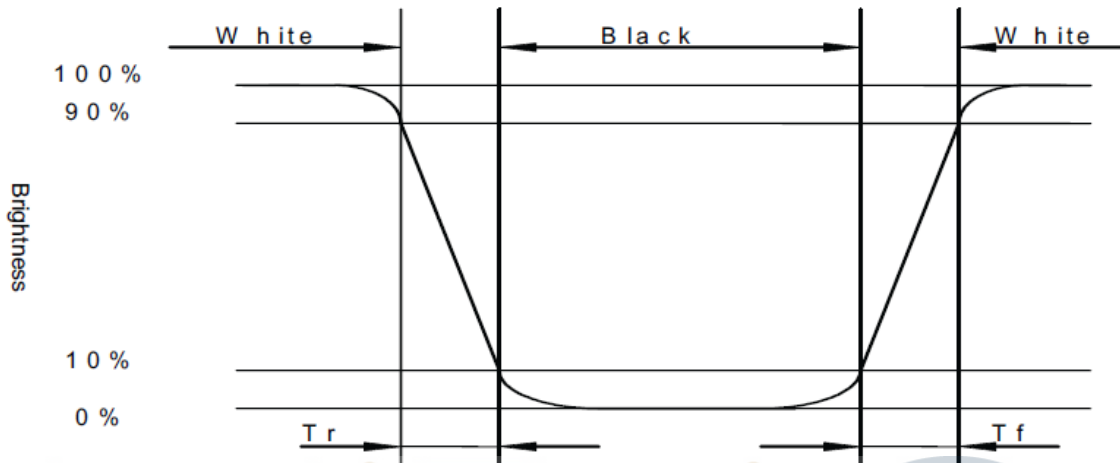

Note 4: Viewing angle range is defined as follow:

Viewing angle is measured at the center point of the LCD.

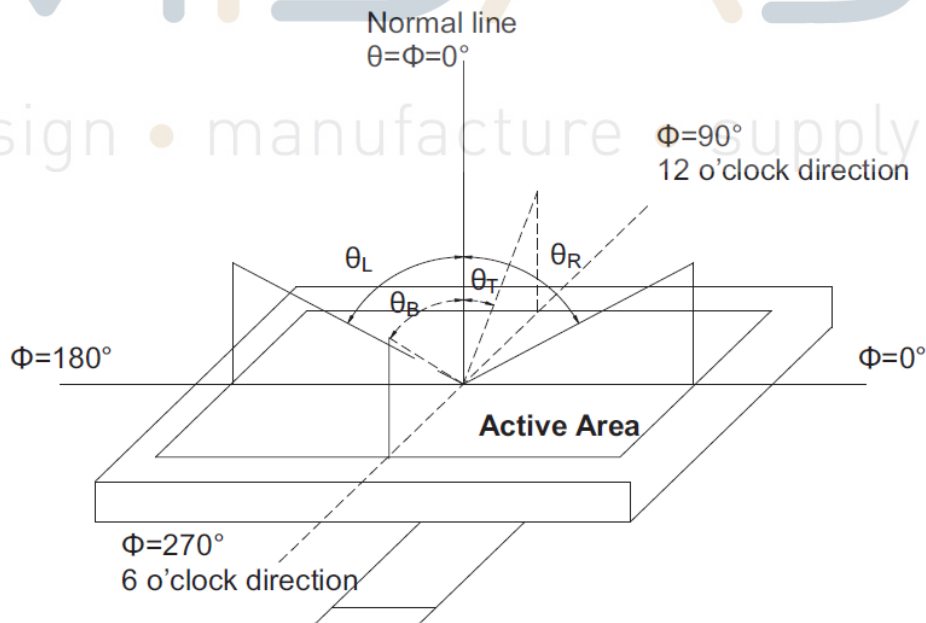

Note 5: Color chromaticity is defined as follow: (CIE1931)

Color coordinates measured at center point of LCD.

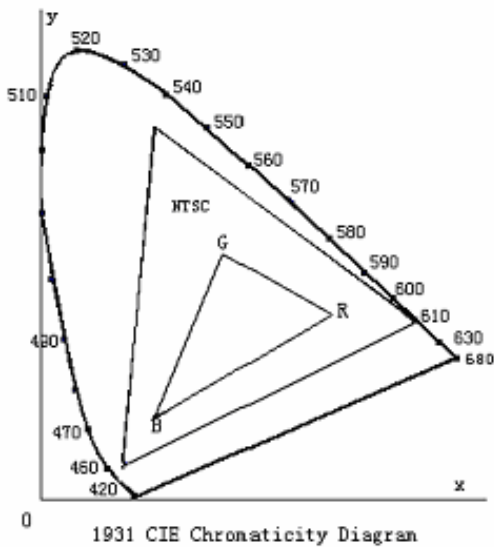

$$S = \frac{\text{area of RGB triangle}}{\text{area of NTSC triangle}} \times 100\%$$

Note 6: Luminance is defined as follow:

Luminance is defined as the brightness of all pixels “White” at the center of display area on optimum contrast.

Note 7: Luminance Uniformity is defined as follow:

Active area is divided into 9 measuring areas (Refer Fig. 2). Every measuring point is placed at the center of each measuring area.

$$\text{Uniformity}(U) = \frac{\text{Minimum Luminance(brightness) in 9 points}}{\text{Maximum Luminance(brightness) in 9 points}}$$

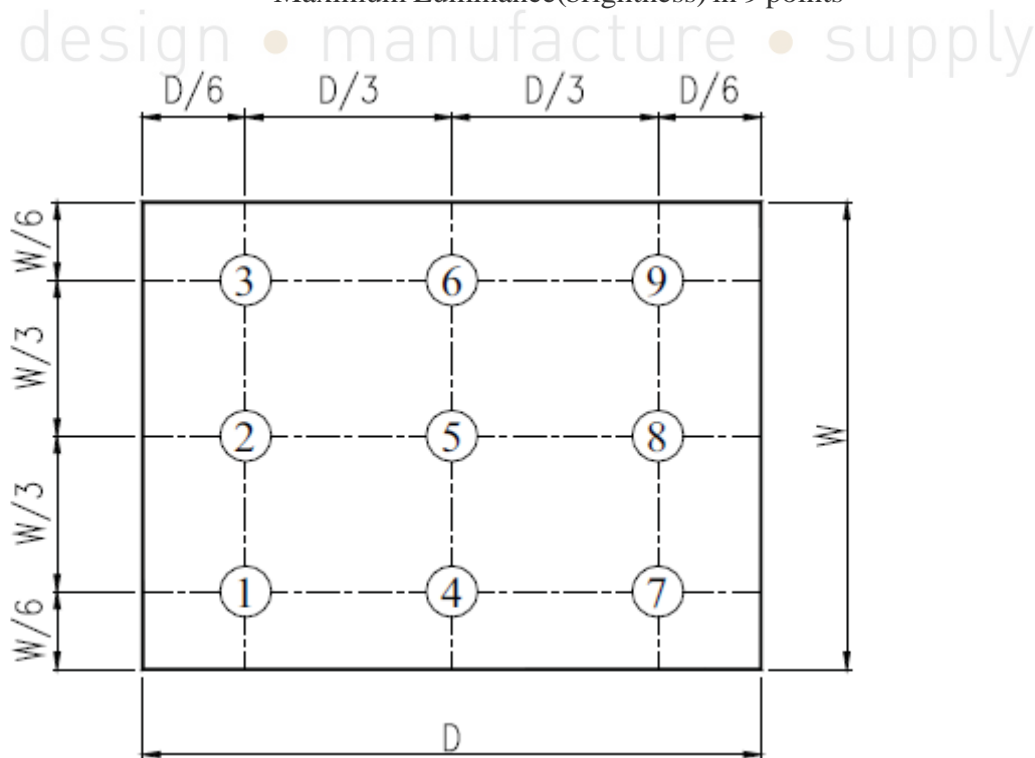

Fig. 2 Definition of uniformity



10. Environmental / Reliability Tests

No	Test Item	Condition	Judgment criteria
1	High Temp Operation	Ts=+70°C, 96hrs	Per table in below
2	Low Temp Operation	Ta=-20°C, 96hrs	Per table in below
3	High Temp Storage	Ta=+80°C, 96hrs	Per table in below
4	Low Temp Storage	Ta=-30°C, 96hrs	Per table in below
5	High Temp & High Humidity Storage	Ta=+60°C, 90% RH 96 hours	Per table in below (polarizer discoloration is excluded)
6	Thermal Shock (Non-operation)	-30°C 30 min~+80°C 30 min, Change time:5min, 5 Cycles	Per table in below
7	ESD (Operation)	C=150pF, R=330Ω · 5points/panel Air:±8KV, 5times; Contact:±4KV, 5 times;	Per table in below
8	Vibration (Non-operation)	10Hz~150Hz, 100m/s ² , 120min	Per table in below
9	Shock (Non-operation)	Half- sine wave, 300m/s ² , 11ms	Per table in below
10	Package Drop Test	Height:80 cm, 1 corner, 3 edges, 6 surfaces	Per table in below

INSPECTION	CRITERION(after test)
Appearance	No Crack on the FPC, on the LCD Panel
Alignment of LCD Panel	No Bubbles in the LCD Panel No other Defects of Alignment in Active area
Electrical current	Within device specifications
Function / Display	No Broken Circuit, No Short Circuit or No Black line No Other Defects of Display



11. Precautions for Use of LCD Modules

11.1 Safety

The liquid crystal in the LCD is poisonous. Do not put it in your mouth. If the liquid crystal touches your skin or clothes, wash it off immediately using soap and water.

11.2 Handling

- A. The LCD and touch panel is made of plate glass. Do not subject the panel to mechanical shock or to excessive force on its surface.
- B. Do not handle the product by holding the flexible pattern portion in order to assure the reliability
- C. Transparency is an important factor for the touch panel. Please wear clear finger sacks, gloves and mask to protect the touch panel from finger print or stain and also hold the portion outside the view area when handling the touch panel.
- D. Provide a space so that the panel does not come into contact with other components.
- E. To protect the product from external force, put a covering lens (acrylic board or similar board) and keep an appropriate gap between them.
- F. Transparent electrodes may be disconnected if the panel is used under environmental conditions where dew condensation occurs.
- G. Property of semiconductor devices may be affected when they are exposed to light, possibly resulting in IC malfunctions.
- H. To prevent such IC malfunctions, your design and mounting layout shall be done in the way that the IC is not exposed to light in actual use.

11.3 Static Electricity

- A. Ground soldering iron tips, tools and testers when they are in operation.
- B. Ground your body when handling the products.
- C. Power on the LCD module before applying the voltage to the input terminals.
- D. Do not apply voltage which exceeds the absolute maximum rating.
- E. Store the products in an anti-electrostatic bag or container.

11.4 Storage

- A. Store the products in a dark place at $+25^{\circ}\text{C} \pm 10^{\circ}\text{C}$ with low humidity (40% RH to 60% RH). Don't expose to sunlight or fluorescent light.
- B. Storage in a clean environment, free from dust, active gas, and solvent.

11.5 Cleaning

- A. Do not wipe the touch panel with dry cloth, as it may cause scratch.
- B. Wipe off the stain on the product by using soft cloth moistened with ethanol. Do not allow ethanol to get in between the upper film and the bottom glass. It may cause peeling issue or defective operation. Do not use any organic solvent or detergent other than ethanol.

16.6 Cautions for installing and assembling

Bezel edge must be positioned in the area between the Active area and View area. The bezel may press the touch screen and cause activation if the edge touches the active area. A gap of approximately 0.5mm is needed between the bezel and the top electrode. It may cause unexpected activation if the gap is too narrow. There is a tolerance of 0.2 to 0.3mm for the outside dimensions of the touch panel and tail. A gap must be made to absorb the tolerance in the case and connector.

In order to make the display assembly stable and firm, Midas recommends to design some supporting at the display backside, especially for the display with tape-attached touch panel, such supporting is important and essential, or else, the display may drop-off from front after some period of time.

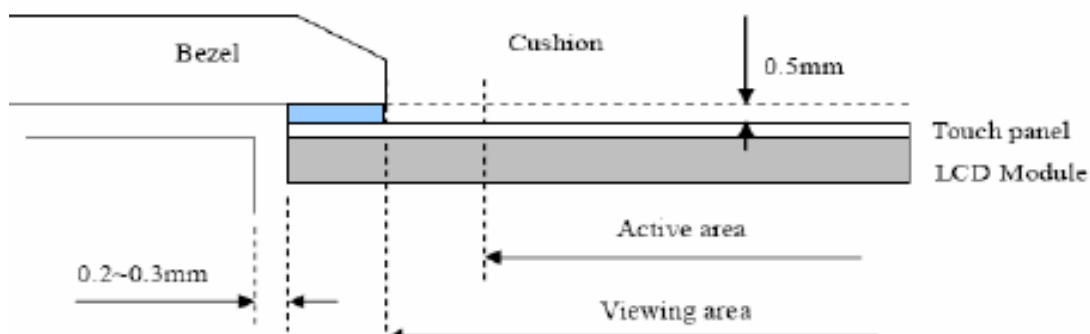

X-ON Electronics

Largest Supplier of Electrical and Electronic Components

Click to view similar products for [Midas](#) manufacturer:

Other Similar products are found below :

[MC22405A6WK-SPTLY-V2](#) [MDT0520COH-HDMI](#) [MDOB256064BX-GM](#) [MC11606A6W2-SPTLY](#) [MC11606C6WK-SPTLY](#)
[MC11606C6W-SPTLY](#) [MC11608A6WK1-BNMLW](#) [LEDV3](#) [MC11606A6W-SPTLY-V2](#) [MC21605A6WK-BNMLW-V2](#) [MC21605AB6W-](#)
[GPTLY-V2](#) [MC128064D6W-BNMLW-V2](#) [MCOT256064B1A-WM](#) [MCT050HDMI-A-CTP](#) [MCOT256064DY-BM](#) [MDOB41605AV-EYM](#)
[MC11606C6WR-FPTLW](#) [MCT024N0TW240320PMLIPS](#) [MC11605A6WR-BNMLW-V2](#) [MC22405A6WK-FPTLW-V2](#)
[MDE029A128296RBW](#) [MDOB256064CX-GM](#) [MDOB256064GX-MWU](#) [MC11606A6WR2-SPTLY](#) [MDT0700A0OSC-PAR-KIT1](#) [MCIB-](#)
[13](#) [MC144032B6WC-SPTLY](#) [MC21605G12W-VNMLG](#) [MCCOG-I2C-I-8](#) [MC21605B6W-FPTLW-V2](#) [MCOT128128RV-WM](#)
[MDT0500D1OSC-PAR-KIT1](#) [MCOT096016BY-WI](#) [MC21605H6WK-SPTLY-V2](#) [MC21605J6W-SPTLY-V2](#) [MPBV2](#) [MC44005A6W-](#)
[FPTLW-V2](#) [MDOB256064AX-YM](#) [MDT0700A11OS-RGB2HDMI-KIT1](#) [MC11615A6W-BNMLW-V2](#) [MC41605A6W-SPR-V2](#)
[MC122032B6W-SPR-V2](#) [MC128064C6W-FPTLW-V2](#) [MC128064C6W-SPTLY-V2](#) [MCOT096064AZ-RGBM](#) [MC20805A12W-VNMLW](#)
[MDE021A104212RBW](#) [MC21605C6W-FPTLA-V2](#) [MC21605C6W-FPTLR-V2](#) [MC21605G6WD-SPTLY-V2](#)