

PRODUCT SPECIFICATIONS

For Customer: _____

: APPROVAL FOR SPECIFICATION

Customer Model No. _____

: APPROVAL FOR SAMPLE

Module No.: 5" TFT with CTP and bezel

Date : 2020-02-28

Table of Contents

No.	Item	Page
1	Cover Sheet(Table of Contents)	P1
2	Revision Record	P2
3	General Specifications	P3
4	Outline Drawing	P4
5	Absolute Maximum Ratings	P5
6	Electrical Specifications	P6-P8
7	Optical Characteristics	P9-P12
8	Reliability Test Items and Criteria	P13
9	Precautions for Use of LCD Modules	P14-P15

For Customer's Acceptance:

Approved By	Comment

PREPARED	CHECKED	VERIFIED BY QA DEPT	VERIFIED BY R&D DEPT

2. Revision Record

Date	Rev.No.	Page	Revision Items	Prepared

3. General Specifications

5" TFT with Capacitive Touch Screen and bezel is composed of a TFT - LCD panel, driver IC, FPC, TP, a back light unit. The 5" display area contains 800 x 480pixels and can display up to 16.7M colors.

This product accords with RoHS environmental criterion.

Item	Contents	Unit	Note
LCD Type	TFT	-	
Display color	16.7M	-	1
Viewing Direction	12	O'Clock	
Gray inversion	6	O'Clock	
Operating temperature	-20~+70	°C	
Storage temperature	-30~+80	°C	
Module size	136.0X92.8X5.28	mm	2
Active Area(W×H)	108.0X64.8	mm	
Number of Dots	800×480	dots	
TFT Controller	ILI5960+ILI6122	-	
CTP Driver	FT5426	-	
Power Supply Voltage	3.3	V	
Backlight	6S3P-LEDs (white)	pcs	
Weight	---	g	
Interface	RGB888	-	

Note 1: Color tune is slightly changed by temperature and driving voltage.

Note 2: Without FPC and Solder.With CTP

4.Outline.Drawing

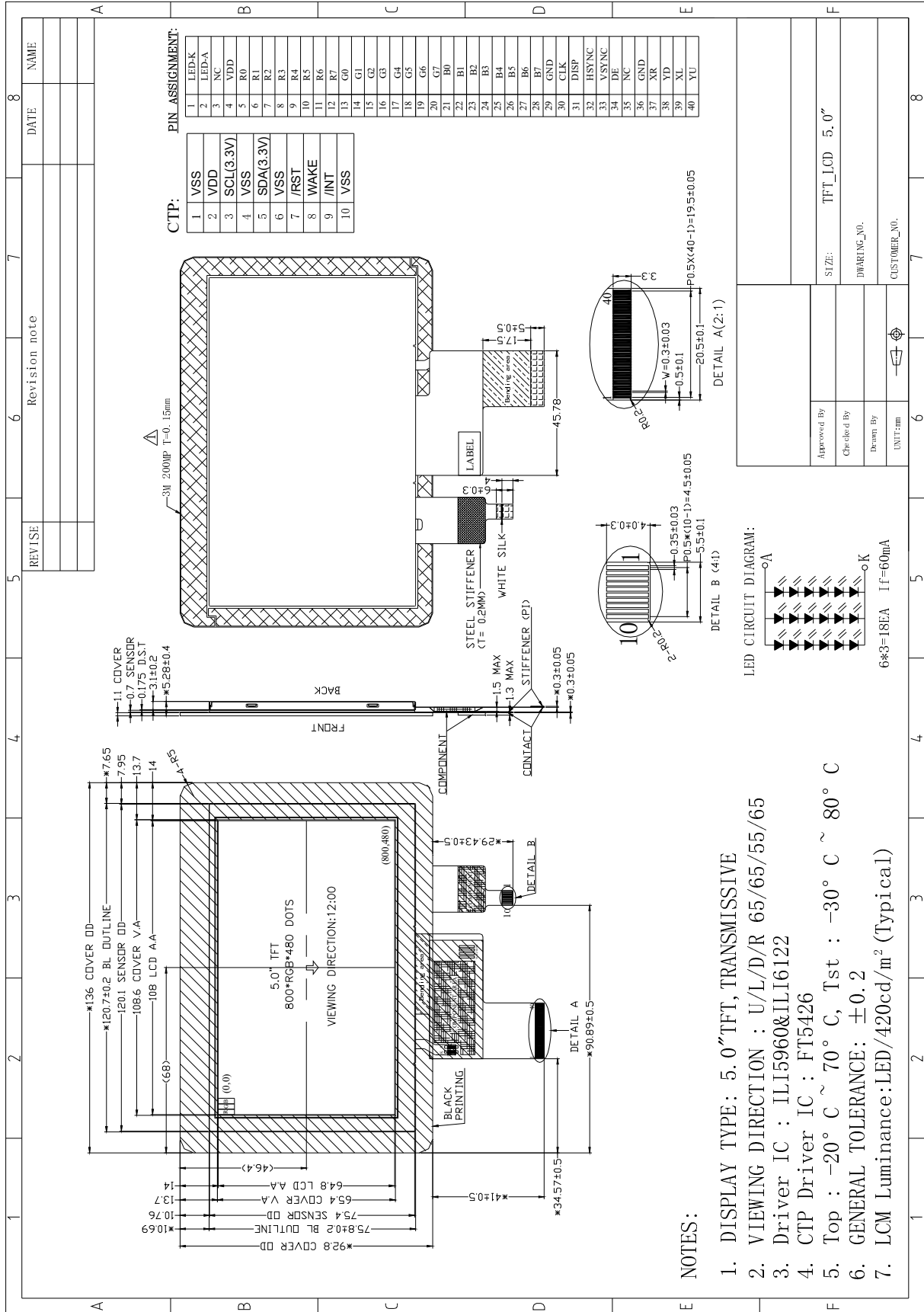

5. Absolute Maximum Ratings ($T_a=25\text{ }^\circ\text{C}$)

5.1 Electrical Absolute Maximum Ratings. ($V_{SS}=0V, T_a=25\text{ }^\circ\text{C}$)

Item	Symbol	Min.	Max.	Unit	Note
Power Supply Voltage	VDD	-0.5	5.0	V	1, 2
Power Supply Voltage	VDD-CTP	2.7	3.6	V	1, 2

Notes:

- If the module is above these absolute maximum ratings. It may become permanently damaged. Using the module within the following electrical characteristic conditions are also exceeded, the module will malfunction and cause poor reliability.
- $V_{DD} > V_{SS}$ must be maintained.

5.2 Environmental Absolute Maximum Ratings.

Item	Storage		Operating		Note
	MIN.	MAX.	MIN.	MAX.	
Ambient Temperature	$-30\text{ }^\circ\text{C}$	$80\text{ }^\circ\text{C}$	$-20\text{ }^\circ\text{C}$	$70\text{ }^\circ\text{C}$	1,2
Humidity	-	-	-	-	3

Notes:

- The response time will become lower when operated at low temperature.
- Background color changes slightly depending on ambient temperature.
The phenomenon is reversible.
- $T_a \leq 40\text{ }^\circ\text{C}$: 85%RH MAX.
 $T_a > 40\text{ }^\circ\text{C}$: Absolute humidity must be lower than the humidity of 85%RH at $40\text{ }^\circ\text{C}$.

6. Electrical Specifications

6.1 Electrical characteristics ($V_{SS}=0V, T_a=25^\circ C$)

Parameter	Symbol	Condition	Min	Typ	Max	Unit	Note
Power supply	VDD	$T_a=25^\circ C$	3.0	3.3	3.6	V	
Power supply	VDD-CTP	$T_a=25^\circ C$	2.8	-	3.3	V	
Input voltage	'H'	V_{IH}	$V_{DD}=3.3V$	$0.7V_{DD}$	-	V_{DD}	V
	'L'	V_{IL}	$V_{DD}=3.3V$	0	-	$0.3V_{DD}$	V

6.2 LED backlight specification ($V_{SS}=0V, T_a=25^\circ C$)

Item	Symbol	Condition	Min	Typ	Max	Unit	Note
Supply voltage	V_f	$I_f=60mA$	16.8	18.0	19.2	V	
Uniformity	ΔB_p	$I_f=60mA$	75	80	-	%	
Life Time	time	$I_f=60mA$	20K	-		hours	1

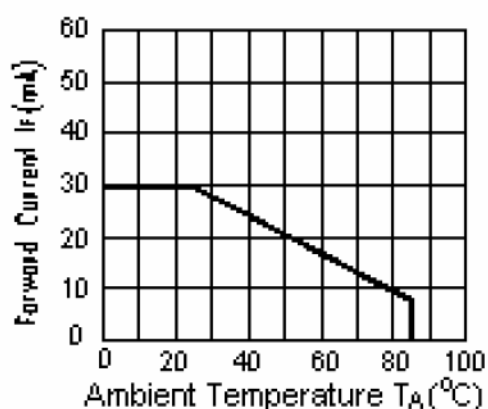

Note 1: Brightness to be decreased to 50% of the initial value at ambient temperature $T_A=25^\circ C$

6.3 Interface signals

Pin No.	Symbol	I/O	Function
1	LED-K	P	LED backlight(Cathode)
2	LED-A	P	LED backlight(anode)
3	NC	-	NC
4	VDD	P	Power supply
5-12	R0-R7	I	Red data bus
13-20	G0-G7	I	Green data bus
21-28	B0-B7	I	Blue data bus
29	GND	P	Ground
30	CLK	I	Clodk
31	DISP	I	Display on/off
32	HSYNC	I	Horizontal synchronous signal
33	VSUNC	I	Vertical synchronous signal
34	DE	I	Data Enable
35	NC	-	NC
36	GND	P	Ground
37	XR	I	RTP pin ,please NC
38	YD	I	
39	XL	I	
40	YU	I	

CTP interface

Pin No	Symbol	I/O	Function
1	VSS	P	Ground
2	VDD	P	CTP Power supply
3	SCL(3.3V)	I	I2C CLOCK
4	VSS	P	Ground
5	SDA(3.3V)	I	I2C DATA
6	VSS	P	Ground
7	/RST	I	CTP Reset PIN,active"L"
8	WAKE	-	No use please NC
9	/INT	-	External Interrupt to the IC of CTP
10	VSS	p	Ground

Note: DZ50-CG385_FT5426_800x480_VA3_D01_20190523_a11

6.4 AC Characteristics

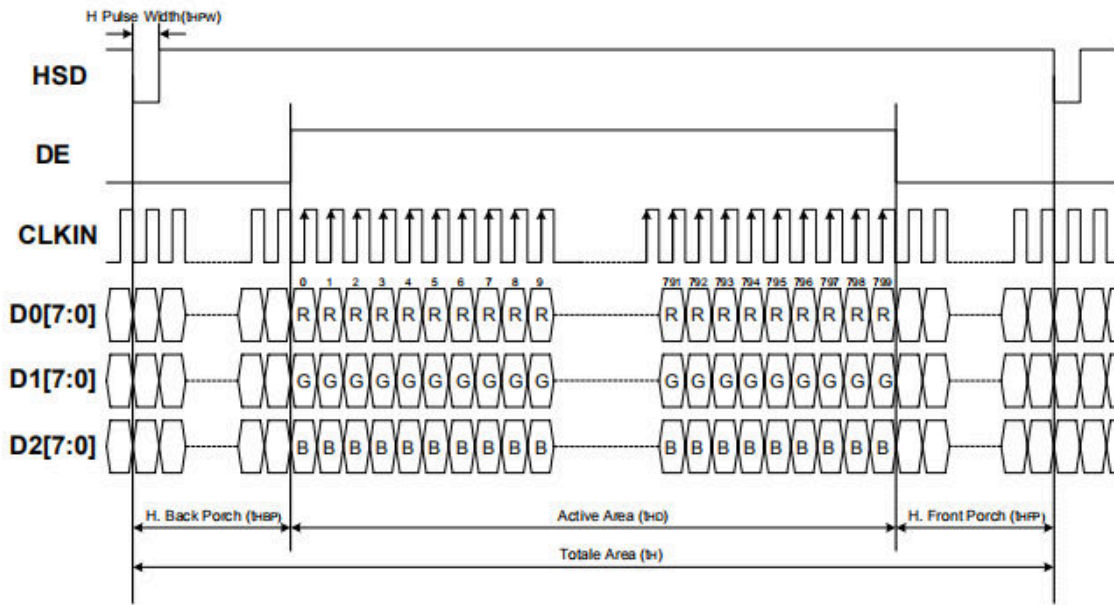

Horizontal Input Timing						
Parameter	Symbol	Value			Unit	
		Min.	Typ.	Max.		
Horizontal display area	t_{HD}	--	800	--	CLKIN	
CLKIN frequency	f_{CLK}	--	33.3	50	MHz	
1 Horizontal line period	t_H	862	1056	1200	CLKIN	
HSD pulse width	Min.	--	1	--	CLKIN	
	Typ.	--	--	--	CLKIN	
	Max.	--	40	--	CLKIN	
HSD back porch	SYNC	t_{HBP}	46	46	46	CLKIN
HSD front porch	SYNC	t_{HFP}	16	210	354	CLKIN

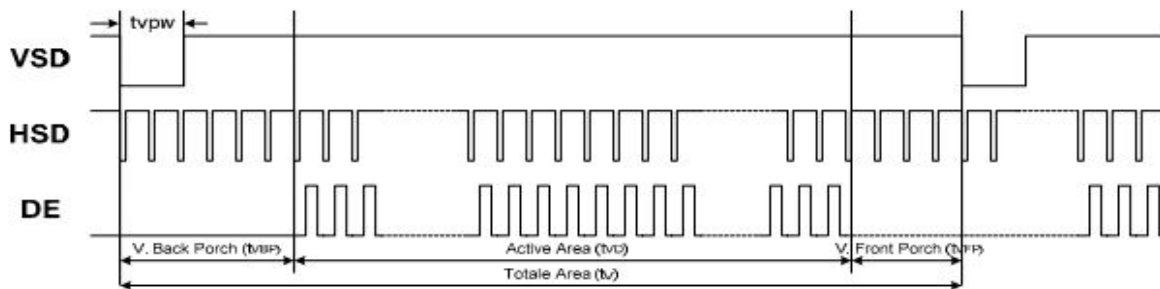

Vertical Input Timing					
Parameter	Symbol	Value			Unit
		Min.	Typ.	Max.	
Vertical display area	t_{VD}	--	480	--	HSD
VSD period time	t_V	510	525	650	HSD
VSD pulse width	t_{VPW}	1	--	20	HSD
VSD back porch	t_{VBP}	23	23	23	HSD
VSD front porch	t_{VFP}	7	22	147	HSD

7. Optical Characteristics

Item	Symbol	Condition	Min.	Typ.	Max.	Unit	Note
Brightness (with TP)	Bp	$\theta=0^\circ$ $\Phi=0^\circ$	-	420	-	Cd/m ²	1
Uniformity	Δ Bp		75	80	-	%	1,2
Viewing Angle	3:00	Cr \geq 10	-	65	-	Deg	3
	6:00		-	55	-		
	9:00		-	65	-		
	12:00		-	65	-		
Contrast Ratio	Cr	$\theta=0^\circ$ $\Phi=0^\circ$	300	500	-	-	4
Response Time	T _r		-	10	20	ms	5
	T _f		-	10	20	ms	
Color of CIE Coordinate	W	x	Typ -0.05	0.328	Typ +0.05	-	1,6
		y		0.340		-	
	R	x		0.57		-	
		y		0.33		-	
	G	x		0.35		-	
		y		0.59		-	
	B	x		0.15		-	
		y		0.09		-	

Note: The parameter is slightly changed by temperature, driving voltage and materiel

Note 1: The data are measured after LEDs are turned on for 5 minutes. LCM displays full white. The brightness is the average value of 9 measured spots. Measurement equipment PR-705 (Φ8mm)

Measuring condition:

- Measuring surroundings: Dark room.
- Measuring temperature: $T_a = 25^\circ\text{C}$
- Adjust operating voltage to get optimum contrast at the center of the display.

Measured value at the center point of LCD panel after more than 5 minutes while backlight turning on.

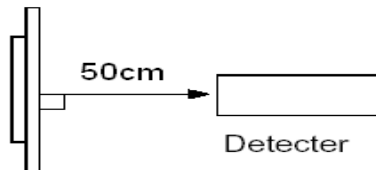

Note 2: The luminance uniformity is calculated by using following formula.

$$\Delta Bp = Bp (\text{Min.}) / Bp (\text{Max.}) \times 100 (\%)$$

$Bp (\text{Max.}) = \text{Maximum brightness in 9 measured spots}$

$Bp (\text{Min.}) = \text{Minimum brightness in 9 measured spots.}$

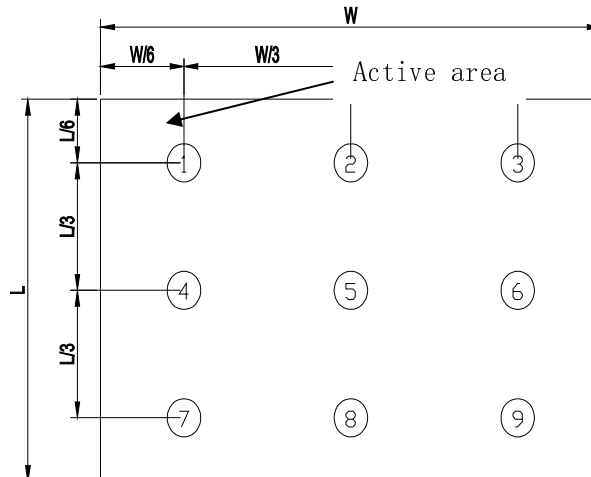

Note 3: The definition of viewing angle:
Refer to the graph below marked by θ and Φ

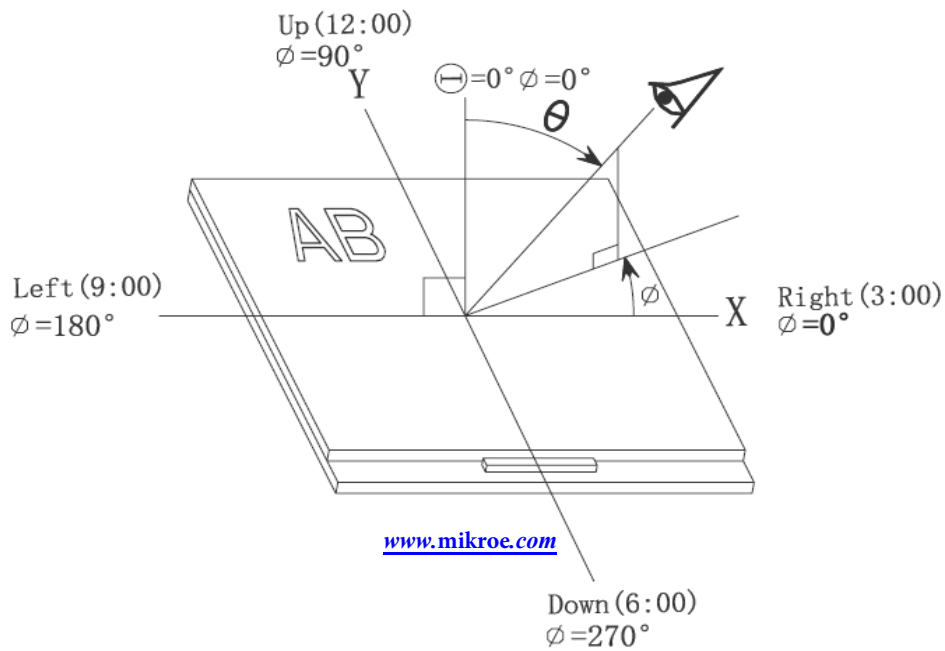

Note 4: Definition of contrast ratio.(Test LCD using DMS501)

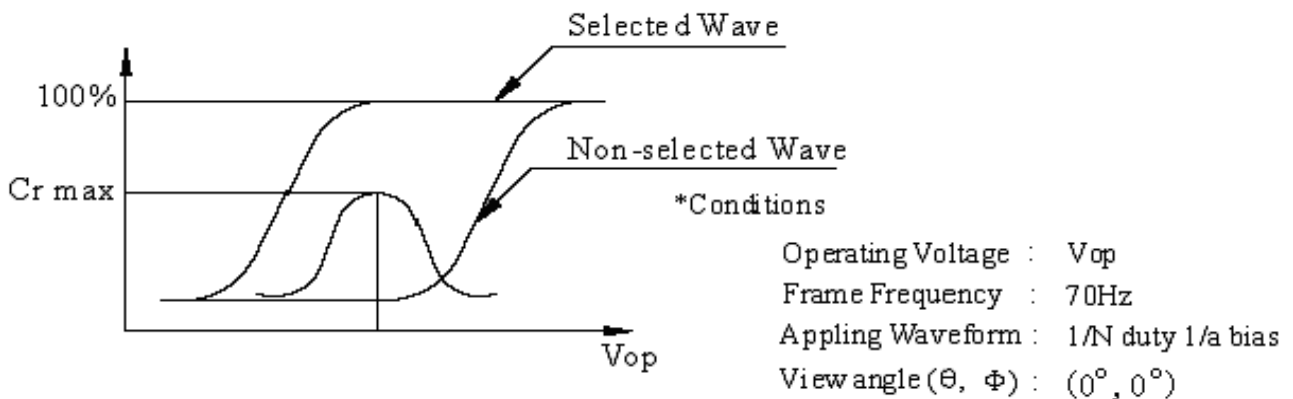

$$\text{Contrast ratio}(Cr) = \frac{\text{Brightness of selected dots}}{\text{Brightness of non-selected dots}}$$

Note 5: Definition of Response time. (Test LCD using DMS501):

The output signals of photo detector are measured when the input signals are changed from “white” to “black”(rising time) and from “black” to “white”(falling time) , respectively. The response time is defined as the time interval between the 10% and 90% of amplitudes.Refer to figure as below.

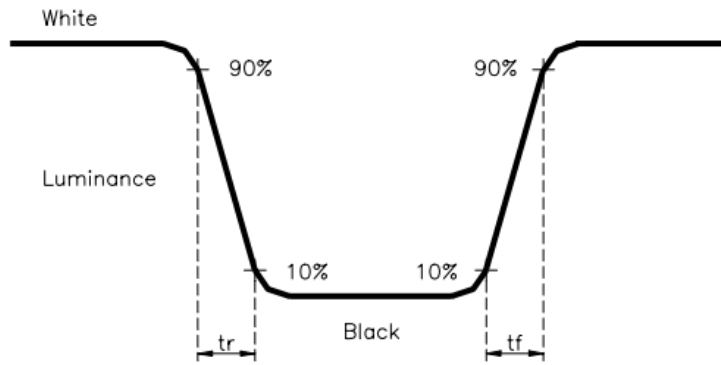

The definition of response time

Note 6: Definition of Color of CIE Coordinate and NTSC Ratio.

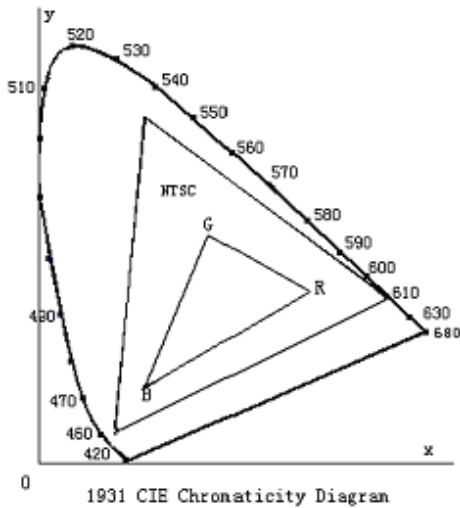

Color gamut:

$$S = \frac{\text{area of RGB triangle}}{\text{area of NTSC triangle}} \times 100\%$$

Note 7: Definition of cross talk.

$$\text{Cross talk ratio}(\%) = \frac{|\text{pattern A Brightness} - \text{pattern B Brightness}|}{\text{pattern A Brightness}} \times 100$$

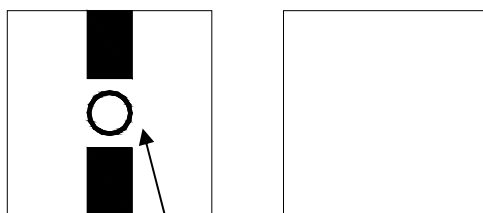

Pattern A

Pattern B

Measurement point(center)

Electric volume value=3F+/-3Hex

8. Reliability Test Items and Criteria

Test Item	Test condition	Remark
High Temperature Storage	$T_s = 80^{\circ}\text{C}$ 96hrs	Note1,Note3, 4
Low Temperature Storage	$T_s = -20^{\circ}\text{C}$ 96hrs	Note1,Note3, 4
High Temperature Operation	$T_s = 70^{\circ}\text{C}$ 96hrs	Note2,Note3, 4
Low Temperature Operation	$T_s = -20^{\circ}\text{C}$ 96hrs	Note1,Note3, 4
Operation at High Temperature/Humidity	+60°C, 90%RH 96hrs	Note3, 4
Thermal Shock	-30°C/30 min ~ +80°C/30 min for a total 10 cycles, Start with cold temperature and end with high	Note3, 4
Vibration Test	Frequency range:10~55Hz Stroke:1.5mm Sweep:10Hz~55Hz~10Hz 2 hours for each direction of X. Y. Z. (6 hours for total)	
Mechanical Shock	100G 6ms,±X, ±Y, ±Z 3 times for each direction	
Package Vibration Test	Random Vibration : 0.015G*G/Hz from 5-200HZ, -6dB/Octave from 200-500HZ 2 hours for each direction of X. Y. Z. (6 hours for total)	
Package Drop Test	Height:60cm 1 corner, 3 edges, 6 surfaces	
Electro Static Discharge	±2KV, Human Body Mode, 100pF/1500Ω	

Note 1: T_a is the ambient temperature of samples.

Note 2: T_s is the temperature of panel's surface.

Note 3: In the standard condition, there shall be no practical problem that may affect the display function. After the reliability test, the product only guarantees operation, but don't guarantee all of the cosmetic specification.

Note 4: Before cosmetic and function test, the product must have enough recovery time,at least 2 hours at room temperature

9. Precautions for Use of LCD Modules

9.1 Handling Precautions

9.1.1 *The display panel is made of glass. Do not subject it to a mechanical shock by dropping it from a high place, etc.*

9.1.2 *If the display panel is damaged and the liquid crystal substance inside it leaks out, be sure not to get any in your mouth, if the substance comes into contact with your skin or clothes, promptly wash it off using soap and water.*

9.1.3 *Do not apply excessive force to the display surface or the adjoining areas since this may cause the color tone to vary.*

9.1.4 *The polarizer covering the display surface of the LCD module is soft and easily scratched. Handle this polarizer carefully.*

9.1.5 *If the display surface is contaminated, breathe on the surface and gently wipe it with a soft dry cloth. If still not completely clear, moisten cloth with one of the following solvents:*

— Isopropyl alcohol — Ethyl alcohol

Solvents other than those mentioned above may damage the polarizer. Especially, do not use the following:

— Water — Ketone — Aromatic solvents

9.1.6 *Do not attempt to disassemble the LCD Module.*

9.1.7 *If the logic circuit power is off, do not apply the input signals.*

9.1.8 *To prevent destruction of the elements by static electricity, be careful to maintain an optimum work environment.*

a. *Be sure to ground the body when handling the LCD Modules.*

b. *Tools required for assembly, such as soldering irons, must be properly ground.*

c. *To reduce the amount of static electricity generated, do not conduct assembly and other work under dry conditions.*

d. *The LCD Module is coated with a film to protect the display surface. Be care when peeling off this protective film since static electricity may be generated.*

9.2 Storage precautions

9.2.1 *When storing the LCD modules, avoid exposure to direct sunlight or to the light of fluorescent lamps.*

9.2.2 *The LCD modules should be stored under the storage temperature range. If the LCD modules will be stored for a long time, the recommend condition is:*

Temperature : 0°C ~ 40°C

Relatively humidity: ≤80%

9.2.3 *The LCD modules should be stored in the room without acid, alkali and harmful gas.*

9.3 *The LCD modules should be no falling and violent shocking during transportation, and also should avoid excessive press, water, damp and sunshine.*

END

X-ON Electronics

Largest Supplier of Electrical and Electronic Components

Click to view similar products for [TFT Displays & Accessories](#) category:

Click to view products by [MikroElektronika](#) manufacturer:

Other Similar products are found below :

[OAI-80038AA-2013-A](#) [HDA430T-3G1H](#) [NB-ATT01](#) [TCG104SVLQAPNN-AN20](#) [OAI-80038AA-2008-A](#) [315-U004B15300](#) [EIC-LCD-1080P](#) [NL10276BC20-18C](#) [DEM 128160D](#) [TMH-PW-N](#) [RFE43BU-AIW-DNG](#) [EA WF050-40S](#) [EA WF050-40ST](#) [RFC350X-AWW-DNG](#) [RFS390E-AWW-DNN](#) [DEM 480272G2](#) [VMX-PW-N \(A-TOUCH\)](#) [PH800480T013-ICA](#) [DEM 1024600N](#) [VMX-PW-N \(C-TOUCH\)](#) [DEM 1024600P](#) [VMH-PW-N \(C-TOUCH\)](#) [SM-RVT50HQHNWCA0](#) [DEM 240280A](#) [VMH-PW-N](#) [DEM 170320A](#) [VMH-PW-N](#) [PH240320T068-LAB08](#) [DEM 800480T1](#) [TMH-PW-N](#) [PH128128T041-LAA07](#) [PH480272T005-IAC02](#) [DEM 1024600P](#) [VMH-PW-N \(A-TOUCH\)](#) [DEM 800480T1](#) [TMH-PW-N \(C-TOUCH\)](#) [DEM 800480Q4](#) [VMX-PW-N](#) [DEM 800480T1](#) [TMH-PW-N \(A-TOUCH\)](#) [PH320240T-023-I02Q](#) [PH128800T004-ZZA01](#) [RFE430W-1YW-DBS](#) [DEM 1024600N](#) [VMX-PW-N \(A-TOUCH\)](#) [PH240320T074-ZAA01](#) [DEM 480480D](#) [VMX-PW-N \(C-TOUCH\)](#) [SM-RVT50HQSNWN00](#) [SM-RVT50HQHNWC00](#) [PH800480T033-ICB01](#) [RFE430W-AWW-DNN](#) [DEM 096096A](#) [VMH-PW-N](#) [RL0F00050000FGAAASA01](#) [SM-RVT50HQSNWCA0](#) [SM-RVT50HQSNWC00-B](#) [PH320240T028-ZEA01](#) [RFE430W-1YW-DBN](#) [SM-RVT50HQHNWC00-B](#) [DEM 120240A](#) [VMH-PW-N](#) [DEM 268800A](#) [VMH-PW-N](#) [RFF700B4-AIW-DNS](#) [DEM 800480O1](#) [VMH-PW-N](#)