

PRODUCT SPECIFICATIONS

For Customer: _____

: APPROVAL FOR SPECIFICATION

Customer Model No. _____

: APPROVAL FOR SAMPLE

Module No.: 7" TFT with CTP

Date : 2019-11-10

Table of Contents

No.	Item	Page
1	Cover Sheet(Table of Contents)	
2	Revision Record	
3	General Specifications	
4	Outline Drawing	
5	Absolute Maximum Ratings	
6	Electrical Specifications	
7	Optical Characteristics	
8	Reliability Test Items and Criteria	
9	Precautions for Use of LCD Modules	

For Customer's Acceptance:

Approved By	Comment

PREPARED	CHECKED	VERIFIED BY QA DEPT	VERIFIED BY R&D DEPT

2. Revision Record

Date	Rev.No.	Page	Revision Items	Prepared

3. General Specifications

7" TFT with Capacitive Touch Screen is composed of a TFT - LCD panel, driver IC, FPC, TP, a back light unit. The 7" display area contains 800 x 480pixels and can display up to 16.7M colors.

This product accords with RoHS environmental criterion.

Note 1: Color tune is slightly changed by temperature and driving voltage.

Note 2: Without FPC and Solder.

Item	Contents	Unit	Note
LCD Type	TFT	-	
Display color	16.7M		
Viewing Direction	12	O'Clock	
Gray scale inversion direction	6	O'Clock	
Operating temperature	-20~+70	°C	
Storage temperature	-30~+80	°C	
Module size	Refer to outline drawing	mm	
Active Area(W×H)	154.08X85.92	mm	
Number of Dots	800×480	dots	
LCM Controller	HX8664&HX8262	-	
CTP Controller	FT5426		
Power Supply Voltage	3.3	V	
Outline Dimensions	Refer to outline drawing	-	
Backlight	3X9-LEDs (white)	pcs	
Weight	---	g	
Interface	RGB-24bit	-	

4.Outline.Drawing

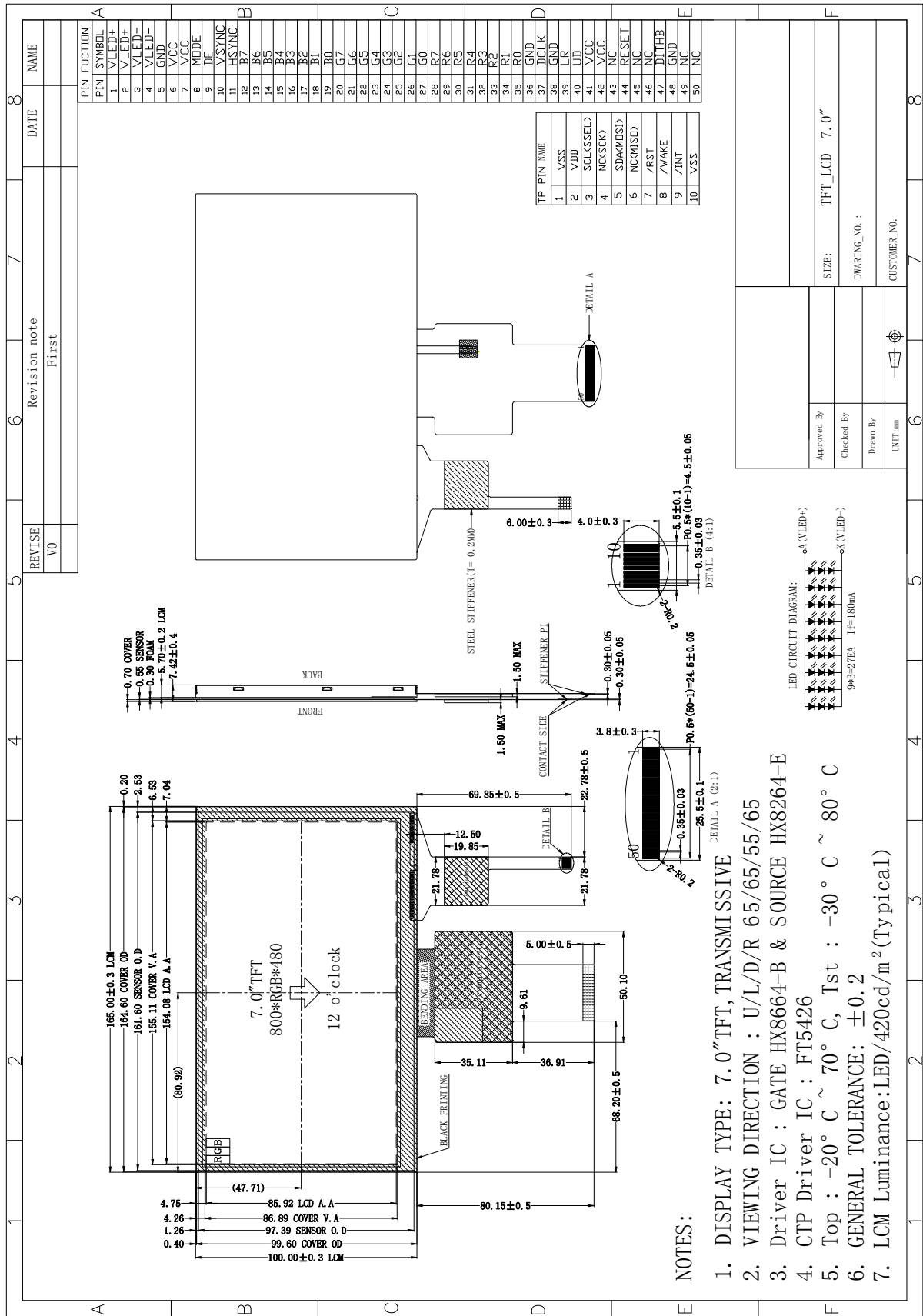

- NOTES:
1. DISPLAY TYPE: 7.0" TFT, TRANSMISSIVE
 2. VIEWING DIRECTION : U/L/D/R 65/65/55/65
 3. Driver IC : GATE HX8664-B & SOURCE HX8264-E
 4. CTP Driver IC : FT5426
 5. Top : -20° C ~ 70° C, Tst : -30° C ~ 80° C
 6. GENERAL TOLERANCE: ±0.2
 7. LCM Luminance: LED/420cd/m²(Typical)

5. Absolute Maximum Ratings($T_a=25\text{ }^\circ\text{C}$)

5.1 Electrical Absolute Maximum Ratings.($V_{SS}=0V, T_a=25\text{ }^\circ\text{C}$)

Item	Symbol	Min.	Max.	Unit	Note
Power Supply Voltage	V_{CC}	-0.3	3.6	V	1, 2

Notes:

1. If the module is above these absolute maximum ratings. It may become permanently damaged. Using the module within the following electrical characteristic conditions are also exceeded, the module will malfunction and cause poor reliability.
2. $V_{CC} > V_{SS}$ must be maintained.

5.2 Environmental Absolute Maximum Ratings.

Item	Storage		Operating		Note
	MIN.	MAX.	MIN.	MAX.	
Ambient Temperature	$-30\text{ }^\circ\text{C}$	$80\text{ }^\circ\text{C}$	$-20\text{ }^\circ\text{C}$	$70\text{ }^\circ\text{C}$	1,2
Humidity	-	-	-	-	3

1. The response time will become lower when operated at low temperature.
2. Background color changes slightly depending on ambient temperature.

The phenomenon is reversible.

3. $T_a \leq 40\text{ }^\circ\text{C}$: 85%RH MAX.

$T_a \geq 40\text{ }^\circ\text{C}$: Absolute humidity must be lower than the humidity of 85%RH at $40\text{ }^\circ\text{C}$.

6. Electrical Specifications and Instruction Code

6.1 Electrical characteristics ($V_{SS}=0V, T_a=25^\circ C$)

Parameter	Symbol	Condition	Min	Typ	Max	Unit	Note
Power supply	VCC	$T_a=25^\circ C$	3.0	3.3	3.6	V	
Input voltage	'H'	$V_{VCC}=3.3V$	$0.8V_{CC}$	-	V_{VCC}	V	
	'L'	$V_{VCC}=3.3V$	0	-	$0.2V_{VCC}$	V	
Current Consumption	I_{DD1}	Normal mode	-	-	-	mA	1
	I_{DD2}	Sleep mode	-	-	-	mA	1

6.2 LED backlight specification ($V_{SS}=0V, T_a=25^\circ C$)

Item	Symbol	Condition	Min	Typ	Max	Unit	Note
Supply voltage	V_f	$I_f=20 \times 9mA$	8.4	9.0	11	V	
Uniformity	ΔB_p	$I_f=20 \times 9mA$	75			%	

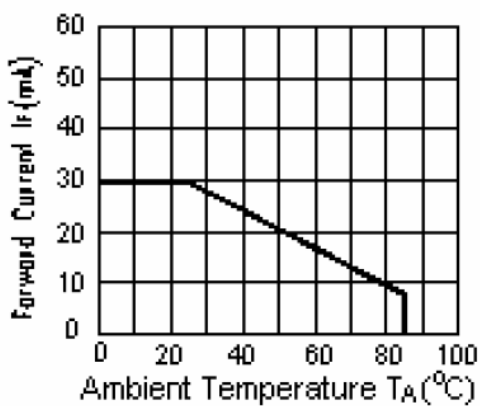

I_{LED} VS TEMP

6.3 Interface signals

Pin No.	Symbol	I/O	Function
1-2	VLED+	P	LED back light(Anode)
3-4	VLED-	P	LED back light(Cathode)
5	GND	P	Ground.
6	VCC	P	Power supply
7	VCC	P	Power supply
8	MODE	I	DE/YSNC mode select
9	DE	I	Data enable pin
10	VSYNC	I	Frame sync signal
11	HSYNC	I	Line sync signal
12-19	B7~B0	I	Blue data bus
20-27	G7~G0	I	Green data bus
28-35	R7~R0	I	Red data bus
36	GND	P	Ground.
37	DCLK	I	Data clock
38	GND	P	Ground.
39	L/R	I	Right/Left sequence control of source driver
40	U/D	I	Gate driver Up/Down scan control of gate driver
41	VCC	P	Power supply
42	VCC	P	Power supply
43	NC	-	No connection.
44	RESET	I	Chip reset pin
45	NC	-	No connection.
46	NC	-	No connection.
47	DITHB	I	Dithering function
48	GND	P	Ground
49-50	NC	-	No connection.

CTP interface

Pin No	Symbol	I/O	Function
1	VSS	P	Ground
2	VDD	P	CTP Power supply
3	SCL	I	Serial clock
4	NC	-	No connection.
5	SDA	I	Serial Input/output data bus
6	NC	-	No connection.
7	/RST	I	Reset the display
8	/WAKE	-	No connection.
9	/INT	I	External Interrupt to the IC of CTP
10	VSS	P	Ground

6.4 AC Characteristics

6.4.1 AC electrical characteristics

Parameter	Symbol	Spec.			Unit
		Min.	Typ.	Max.	
HS setup time	T_{hst}	8	-	-	ns
HS hold time	T_{hhd}	8	-	-	ns
VS setup time	T_{vst}	8	-	-	ns
VS hold time	T_{vhd}	8	-	-	ns
Data setup time	T_{dsu}	8	-	-	ns
Data hold time	T_{dhd}	8	-	-	ns
DE setup time	T_{esu}	8	-	-	ns
DE hold time	T_{ehd}	8	-	-	ns
VDD Power On Slew rate	T_{POR}	-	-	20	ms
RSTB pulse width	T_{Rst}	10	-	-	us
CLKIN cycle time	T_{cph}	20	-	-	ns
CLKIN pulse duty	T_{cwh}	40	50	60	%
Output stable time	T_{sst}	-	-	6	us

- Horizontal timing

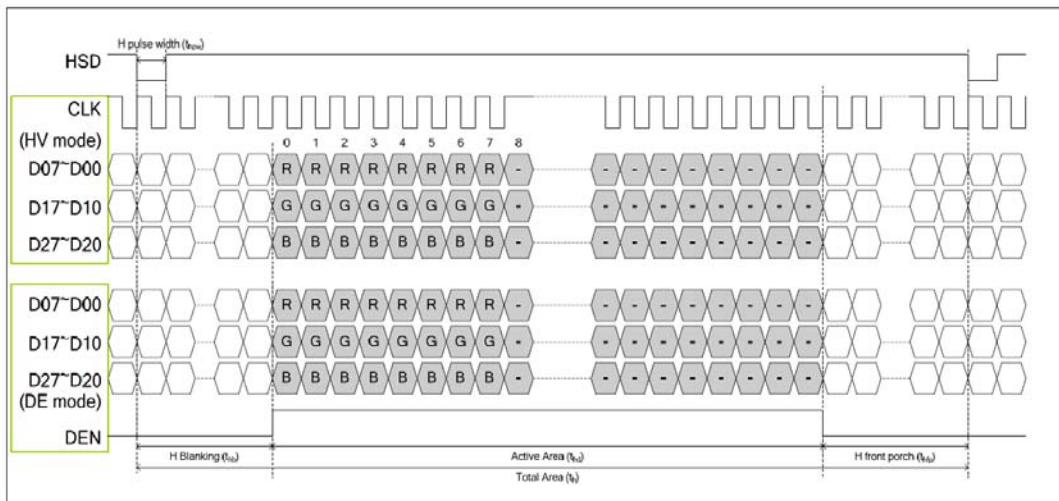

Figure 9. 1 Horizontal Input Timing Diagram

- Vertical timing

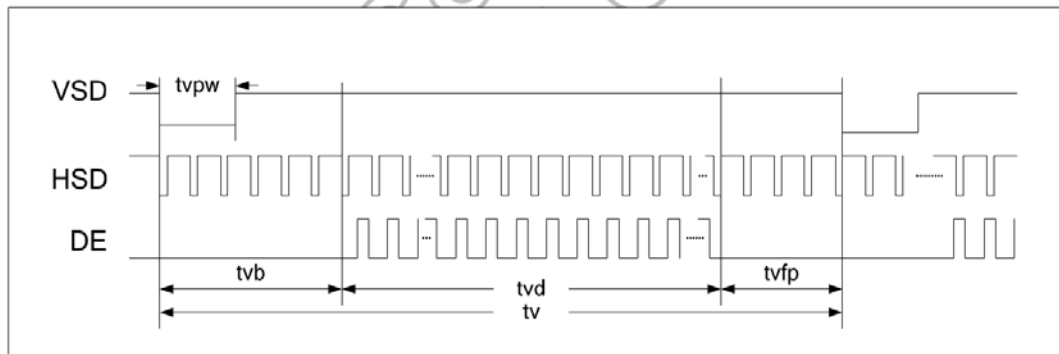

Figure 9. 2 Vertical Input Timing Diagram

6.4.2 data input format

- **Horizontal timing**

Parameter	Symbol	Spec.			Unit
		Min.	Typ.	Max.	
Horizontal Display Area	thd	800			DCLK
DCLK frequency	fclk	-	30	50	MHz
One Horizontal Line	th	889	928	1143	DCLK
HS pulse width	thpw	1	48	255	DCLK
HS Back Porch (Blanking)	thb	88			DCLK
HS Front Porch	thfp	1	40	255	DCLK
DE mode Blanking	th-thd	85	128	512	DCLK

- **Vertical timing**

Parameter	Symbol	Spec.			Unit
		Min.	Typ.	Max.	
Vertical Display Area	tvd	480			T _H
VS period time	tv	513	525	767	T _H
VS pulse width	tvpw	3	3	255	T _H
VS Back Porch (Blanking)	tvb	32			T _H
VS Front Porch	tvfp	1	13	255	T _H
DE mode Blanking	tv-tvd	4	45	255	T _H

6.5 Waveform

6.5.1 parallel RGB mode

Parameter	Symbol	Min.	Typ.	Max.	Unit	Conditions
CLKIN Frequency	Fclk	-	40	50	MHz	VDD=3.0V~3.6V
CLKIN Cycle Time	Tclk	20	25	-	ns	-
CLKIN Pulse Duty	Tcwh	40	50	60	%	Tclk
Time from HSD to Source Output	Thso	64			CLKIN	-
Time from HSD to LD	Thld	64			CLKIN	-
Time from HSD to STV	Thstv	2			CLKIN	-
Time from HSD to CKV	Thckv	20			CLKIN	-
Time from HSD to OEV	Thoev	4			CLKIN	-
LD Pulse Width	Twld	10			CLKIN	-
CKV Pulse Width	Twckv	66			CLKIN	-
OEV Pulse Width	Twoev	74			CLKIN	-

6.5.2 Timing waveform table

6.5.2.1 input clock and data timing waveform

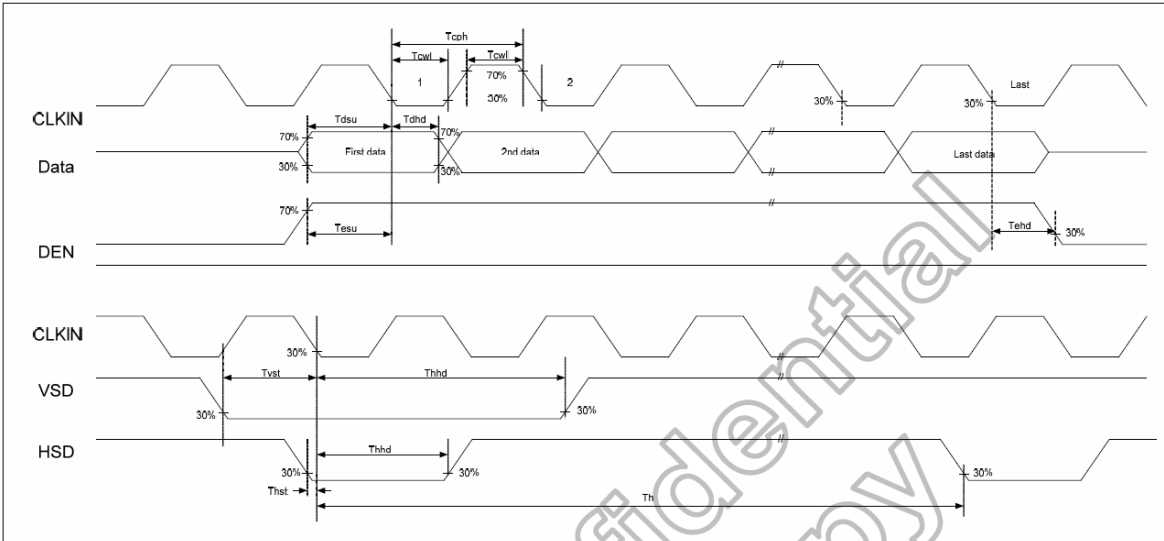

6.5.2.2 Source output timing waveform(Cascade)

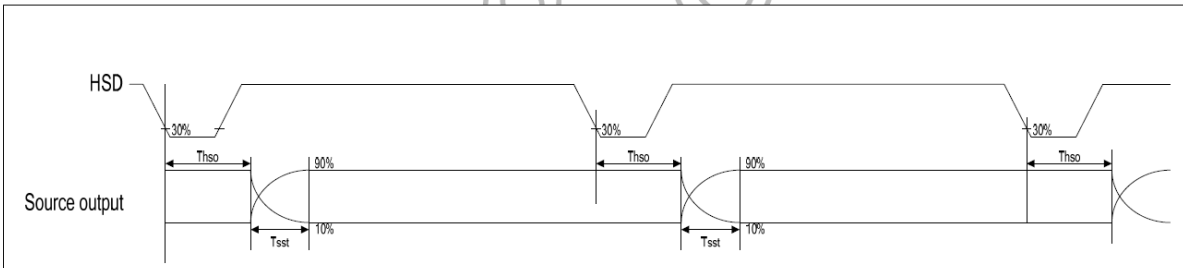

6.5.3 Vertical timing diagram DE(Cascade)

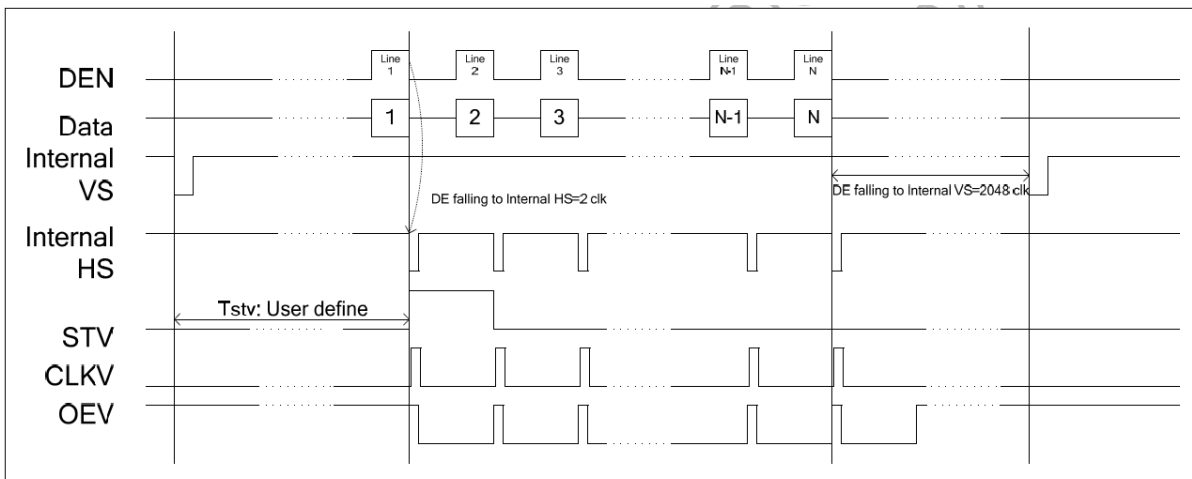

7. Optical Characteristics

Item	Symbol	Condition	Min.	Typ.	Max.	Unit	Note
Brightness	Bp	$\theta=0^\circ$	-	420	-	Cd/m ²	1
Uniformity	ΔBp	$\Phi=0^\circ$	75	-	-	%	1,2
Viewing Angle	3:00	Cr \geq 10	-	65	-	Deg	3
	6:00		-	55	-		
	9:00		-	65	-		
	12:00		-	65	-		
Contrast Ratio	Cr	$\theta=0^\circ$ $\Phi=0^\circ$	300	500	-	-	4
Response Time	T _r		-	10	-	ms	5
	T _f		-	10	-	ms	
Color of CIE Coordinate	W	x	$\theta=0^\circ$ $\Phi=0^\circ$	0.28	-	-	1,6
		y		0.33	-	-	
	R	x		0.51	-	-	
		y		0.34	-	-	
	G	x		0.31	-	-	
		y		0.56	-	-	
	B	x		0.15	-	-	
		y		0.14	-	-	
NTSC Ratio	S	50	60	-	%		

Note: The parameter is slightly changed by temperature, driving voltage and material

Note 1: The data are measured after LEDs are turned on for 5 minutes. LCM displays full white. The brightness is the average value of 9 measured spots. Measurement equipment PR-705 (Φ 8mm)

Measuring condition:

- Measuring surroundings: Dark room.
- Measuring temperature: Ta=25 °C.
- Adjust operating voltage to get optimum contrast at the center of the display.

Measured value at the center point of LCD panel after more than 5 minutes while backlight turning on.

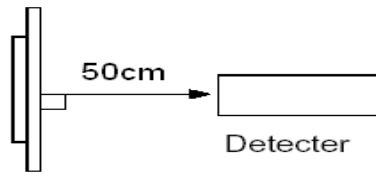

Note 2: The luminance uniformity is calculated by using following formula.

$$\Delta Bp = Bp (\text{Min.}) / Bp (\text{Max.}) \times 100 (\%)$$

$Bp (\text{Max.})$ = Maximum brightness in 9 measured spots

$Bp (\text{Min.})$ = Minimum brightness in 9 measured spots.

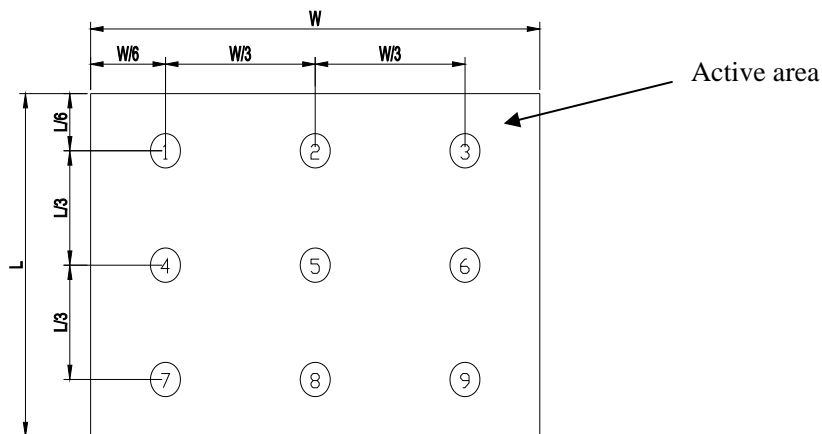

Note 3: The definition of viewing angle:

Refer to the graph below marked by ϑ and Φ

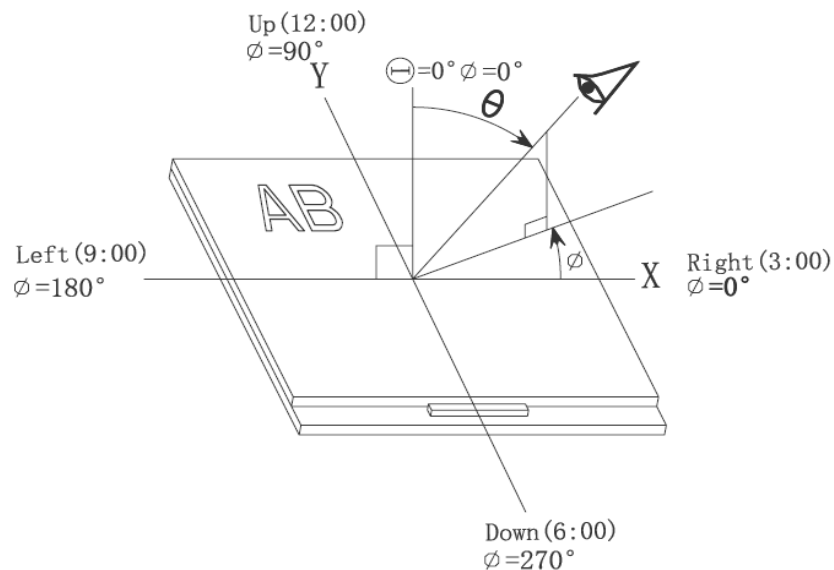

Note 4: Definition of contrast ratio.(Test LCD using DMS501)

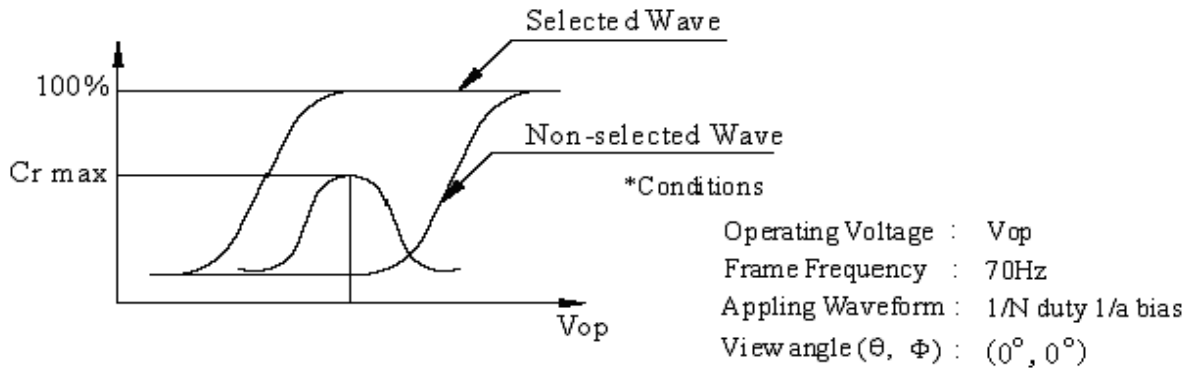

$$\text{Contrast ratio}(Cr) = \frac{\text{Brightness of selected dots}}{\text{Brightness of non-selected dots}}$$

Note 5: Definition of Response time. (Test LCD using DMS501):

The output signals of photo detector are measured when the input signals are changed from "black" to "white"(falling time) and from "white" to "black"(rising time), respectively. The response time is defined as the time interval between the 10% and 90% of amplitudes. Refer to figure as below.

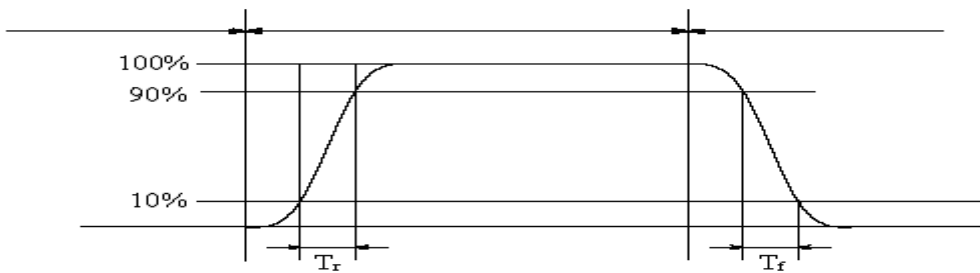

The definition of response time

Note 6: Definition of Color of CIE Coordinate and NTSC Ratio.

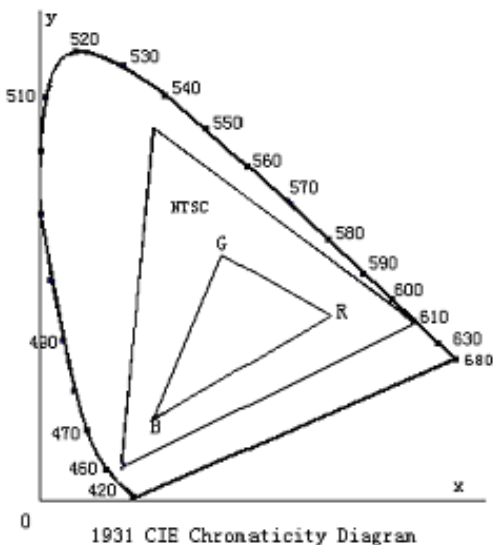

Color gamut:

$$S = \frac{\text{area of RGB triangle}}{\text{area of NTSC triangle}} \times 100\%$$

Note 7: Definition of cross talk.

$$\text{Cross talk ratio}(\%) = \frac{|\text{pattern A Brightness} - \text{pattern B Brightness}|}{\text{pattern A Brightness}} \times 100$$

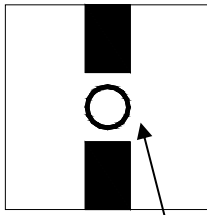

Pattern A



Pattern B

Measurement point(center)

Electric volume value=3F+/-3Hex

8. Reliability Test Items and Criteria

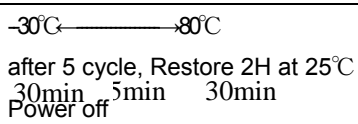
No	Test Item	Test condition	Criterion
1	High Temperature Storage	80°C±2°C 96H Restore 2H at 25°C Power off	1. After testing, cosmetic and electrical defects should not happen. 2. Total current consumption should not be more than twice of initial value.
2	Low Temperature Storage	-30°C±2°C 96H Restore 2H at 25°C Power off	
3	High Temperature Operation	70°C±2°C 96H Restore 2H at 25°C Power on	
4	Low Temperature Operation	-20°C±2°C 96H Restore 4H at 25°C Power on	
5	High Temperature/Humidity Storage	60°C±2°C 90%RH 96H Power off	
6	Temperature Cycle	 after 5 cycle, Restore 2H at 25°C 30min 5min 30min Power off	
7	Vibration Test	10Hz~150Hz, 100m/s ² , 120min	Not allowed cosmetic and electrical defects.
8	Shock Test	Half- sine wave,300m/s ² ,11ms	

Note: Operation: Supply 3.3V for logic system.

The inspection terms after reliability test, as below

ITEM	Inspection
Contrast	CR>50%
IDD	IDD<200%
Brightness	Brightness>60%
Color Tone	Color Tone+/-0,05

9. Precautions for Use of LCD Modules

9.1 Handling Precautions

9.1.1 *The display panel is made of glass. Do not subject it to a mechanical shock by dropping it from a high place, etc.*

9.1.2 *If the display panel is damaged and the liquid crystal substance inside it leaks out, be sure not to get any in your mouth, if the substance comes into contact with your skin or clothes, promptly wash it off using soap and water.*

9.1.3 *Do not apply excessive force to the display surface or the adjoining areas since this may cause the color tone to vary.*

9.1.4 *The polarizer covering the display surface of the LCD module is soft and easily scratched. Handle this polarizer carefully.*

9.1.5 *If the display surface is contaminated, breathe on the surface and gently wipe it with a soft dry cloth. If still not completely clear, moisten cloth with one of the following solvents:*

- Isopropyl alcohol
- Ethyl alcohol

Solvents other than those mentioned above may damage the polarizer. Especially, do not use the following:

- Water
- Ketone
- Aromatic solvents

9.1.6 *Do not attempt to disassemble the LCD Module.*

9.1.7 *If the logic circuit power is off, do not apply the input signals.*

9.1.8 *To prevent destruction of the elements by static electricity, be careful to maintain an optimum work environment.*

a. Be sure to ground the body when handling the LCD Modules.

b. Tools required for assembly, such as soldering irons, must be properly ground.

c. To reduce the amount of static electricity generated, do not conduct assembly and other work under dry conditions.

d. The LCD Module is coated with a film to protect the display surface. Be care when peeling off this protective film since static electricity may be generated.

9.2 Storage precautions

9.2.1 *When storing the LCD modules, avoid exposure to direct sunlight or to the light of fluorescent lamps.*

9.2.2 *The LCD modules should be stored under the storage temperature range. If the LCD modules will be stored for a long time, the recommend condition is:*

Temperature : 0 °C ~ 40 °C

Relatively humidity: ≤80%

9.2.3 *The LCD modules should be stored in the room without acid, alkali and harmful gas.*

9.3 *The LCD modules should be no falling and violent shocking during transportation, and also should avoid excessive press, water, damp and sunshine.*

END

X-ON Electronics

Largest Supplier of Electrical and Electronic Components

Click to view similar products for [TFT Displays & Accessories](#) category:

Click to view products by [MikroElektronika](#) manufacturer:

Other Similar products are found below :

[OAI-80038AA-2013-A](#) [HDA430T-3G1H](#) [NB-ATT01](#) [TCG104SVLQAPNN-AN20](#) [OAI-80038AA-2008-A](#) [315-U004B15300](#) [EIC-LCD-1080P](#) [NL10276BC20-18C](#) [DEM 128160D](#) [TMH-PW-N](#) [RFE43BU-AIW-DNG](#) [EA WF050-40S](#) [EA WF050-40ST](#) [RFC350X-AWW-DNG](#) [RFS390E-AWW-DNN](#) [DEM 480272G2](#) [VMX-PW-N \(A-TOUCH\)](#) [PH800480T013-ICA](#) [DEM 1024600N](#) [VMX-PW-N \(C-TOUCH\)](#) [DEM 1024600P](#) [VMH-PW-N \(C-TOUCH\)](#) [SM-RVT50HQHNWCA0](#) [DEM 240280A](#) [VMH-PW-N](#) [DEM 170320A](#) [VMH-PW-N](#) [PH240320T068-LAB08](#) [DEM 800480T1](#) [TMH-PW-N](#) [PH128128T041-LAA07](#) [PH480272T005-IAC02](#) [DEM 1024600P](#) [VMH-PW-N \(A-TOUCH\)](#) [DEM 800480T1](#) [TMH-PW-N \(C-TOUCH\)](#) [DEM 800480Q4](#) [VMX-PW-N](#) [DEM 800480T1](#) [TMH-PW-N \(A-TOUCH\)](#) [PH320240T-023-I02Q](#) [PH128800T004-ZZA01](#) [RFE430W-1YW-DBS](#) [DEM 1024600N](#) [VMX-PW-N \(A-TOUCH\)](#) [PH240320T074-ZAA01](#) [DEM 480480D](#) [VMX-PW-N \(C-TOUCH\)](#) [SM-RVT50HQSNNWN00](#) [SM-RVT50HQHNWC00](#) [PH800480T033-ICB01](#) [RFE430W-AWW-DNN](#) [DEM 096096A](#) [VMH-PW-N](#) [RL0F00050000FGAAASA01](#) [SM-RVT50HQSNNWCA0](#) [SM-RVT50HQSNNWC00-B](#) [PH320240T028-ZEA01](#) [RFE430W-1YW-DBN](#) [SM-RVT50HQHNWC00-B](#) [DEM 120240A](#) [VMH-PW-N](#) [DEM 268800A](#) [VMH-PW-N](#) [RFF700B4-AIW-DNS](#) [DEM 800480O1](#) [VMH-PW-N](#)