

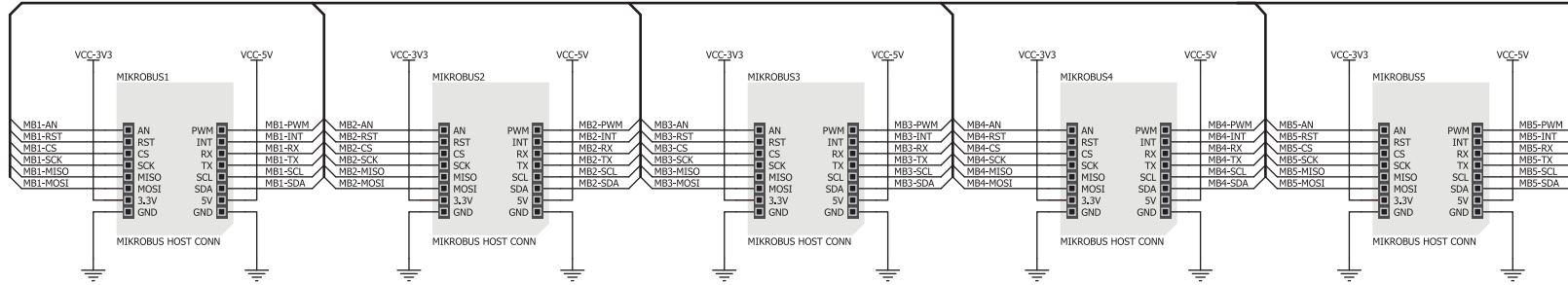

for KINETIS v8 DEVELOPMENT BOARD

SCHEMATIC

mikroBUS sockets



CODEGRIP PDU



TFT Connector

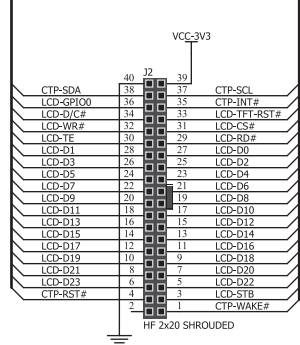

LCD

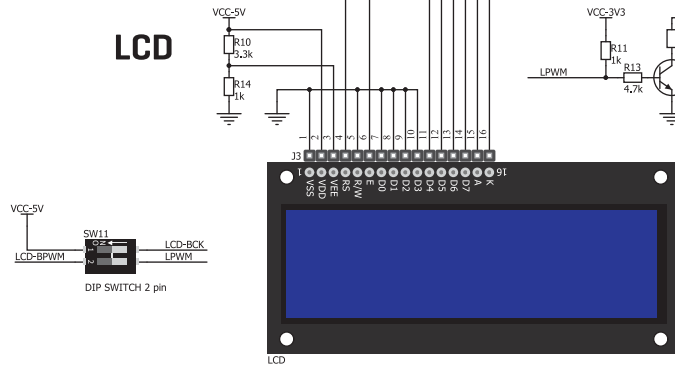

Ethernet

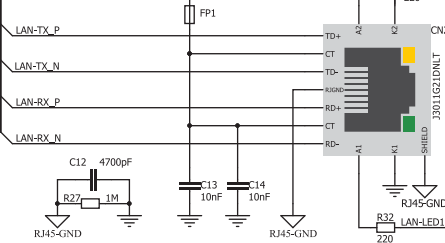

USB POWER/DEBUG

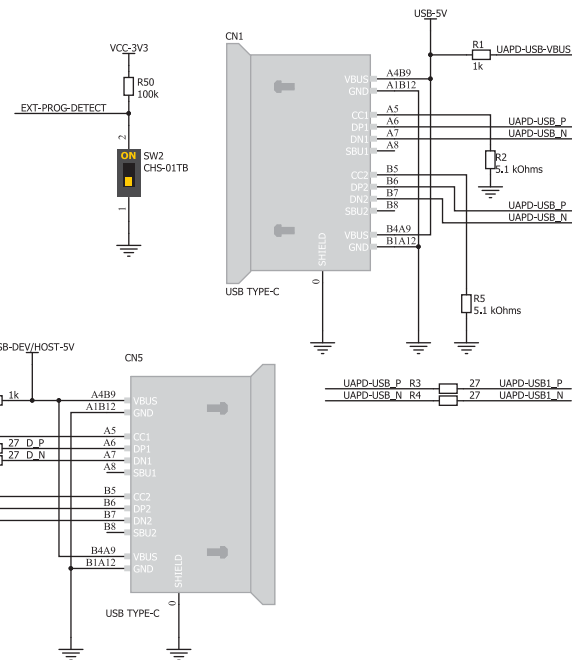

BATTERY

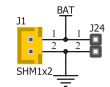

POWER 12VDC

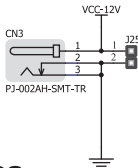

USB Host / Device

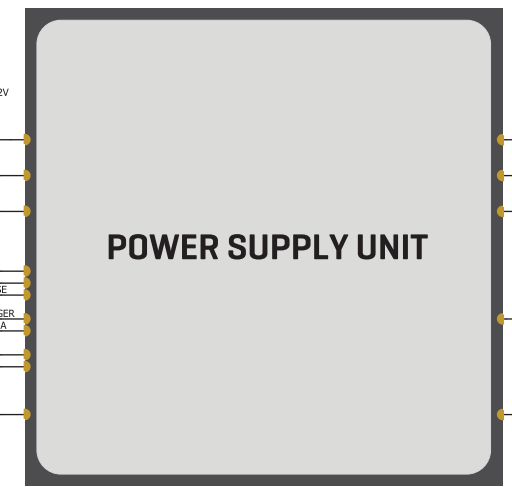
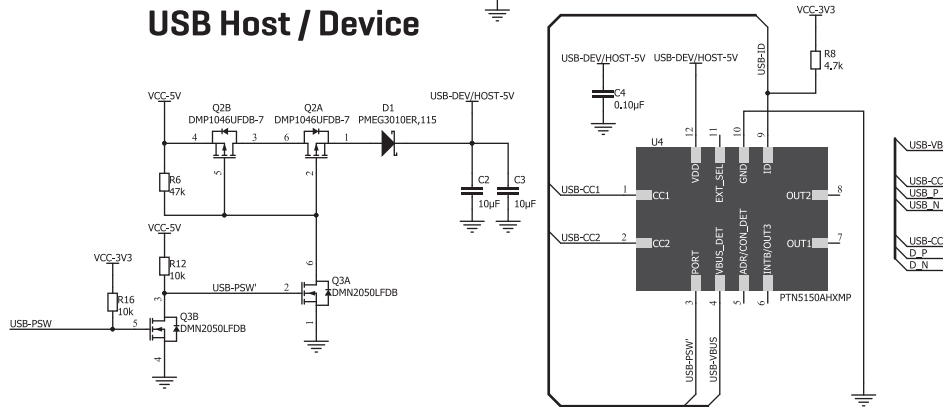

MCU Card Socket

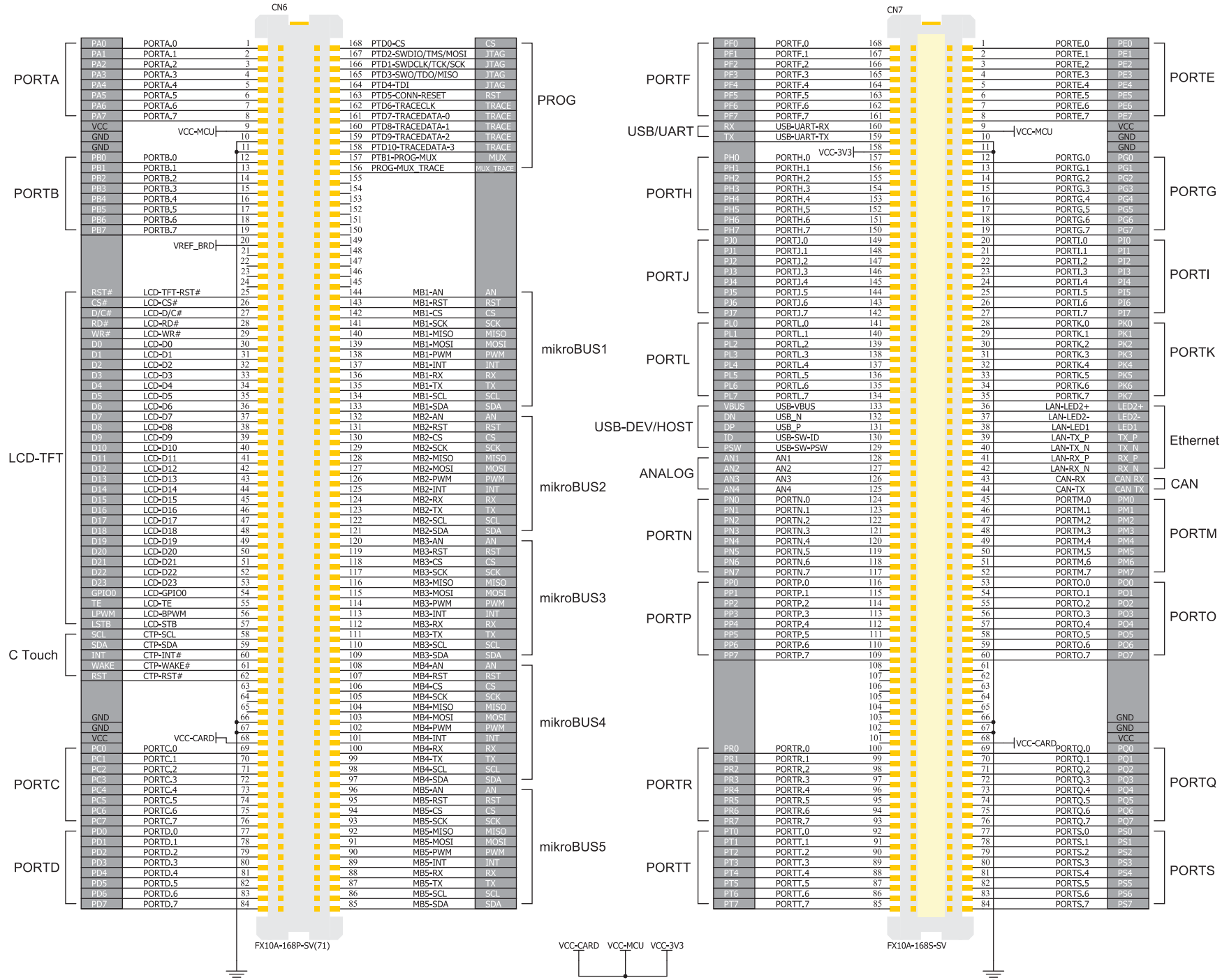
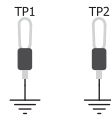

HW. REV. 1.1.11

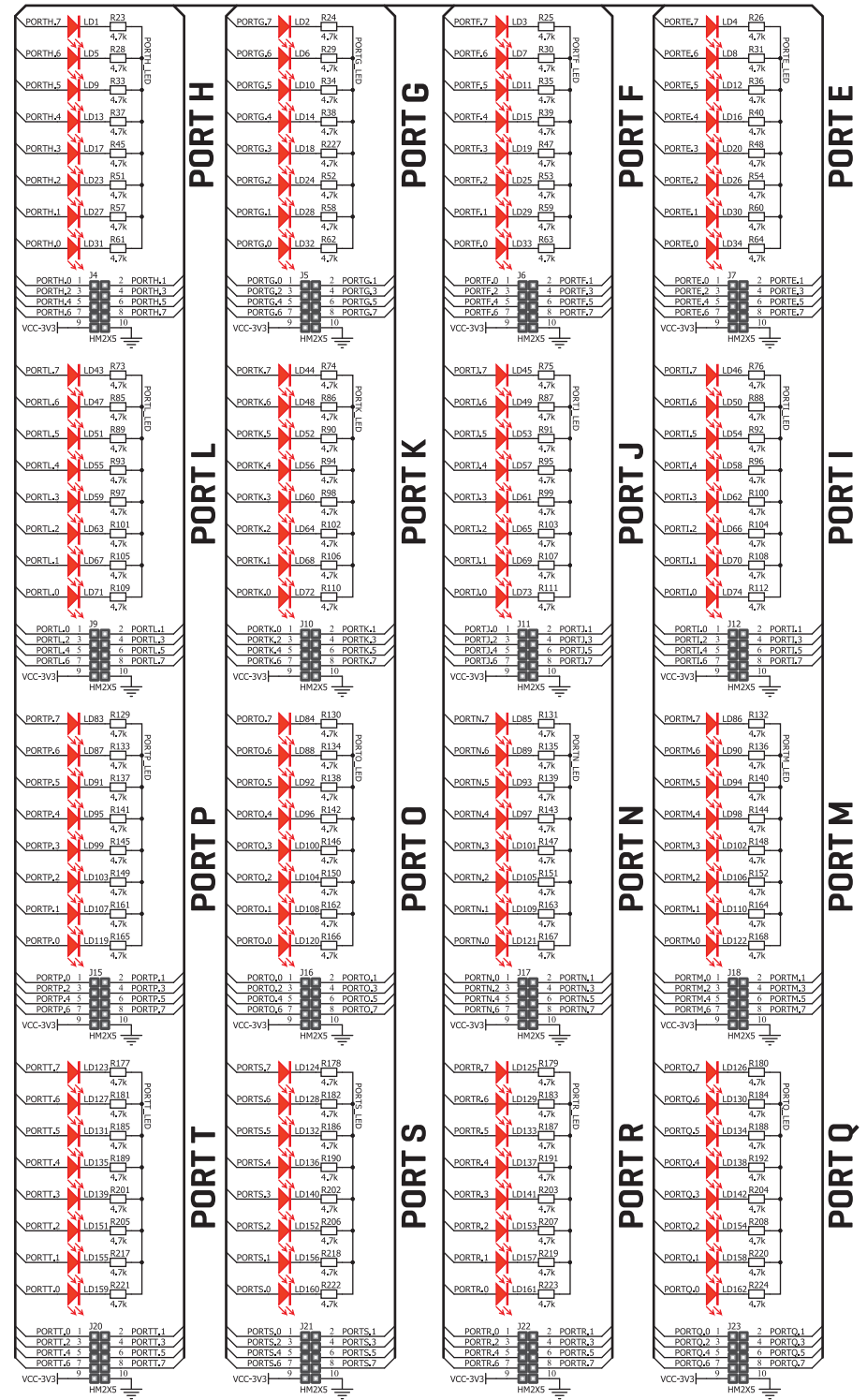
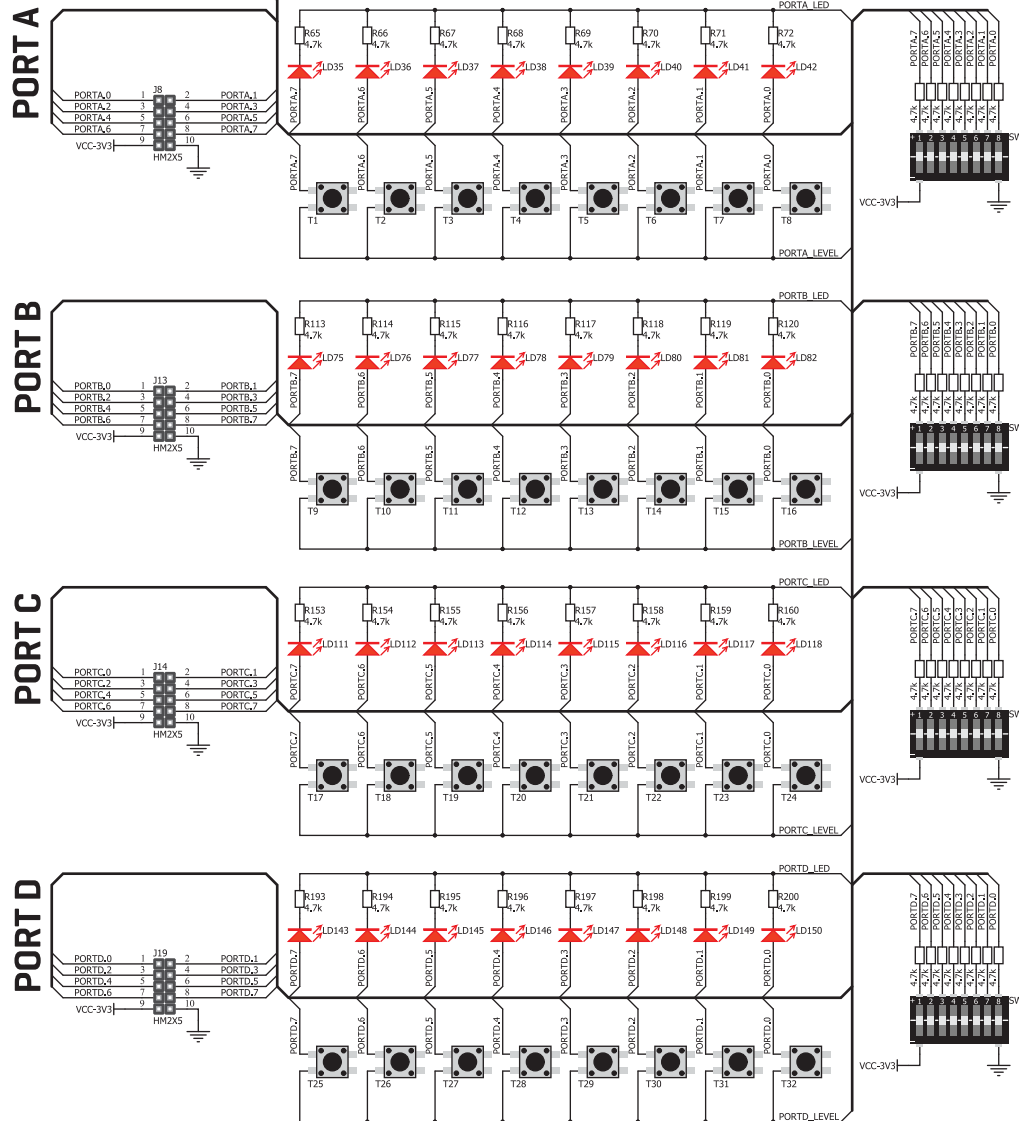
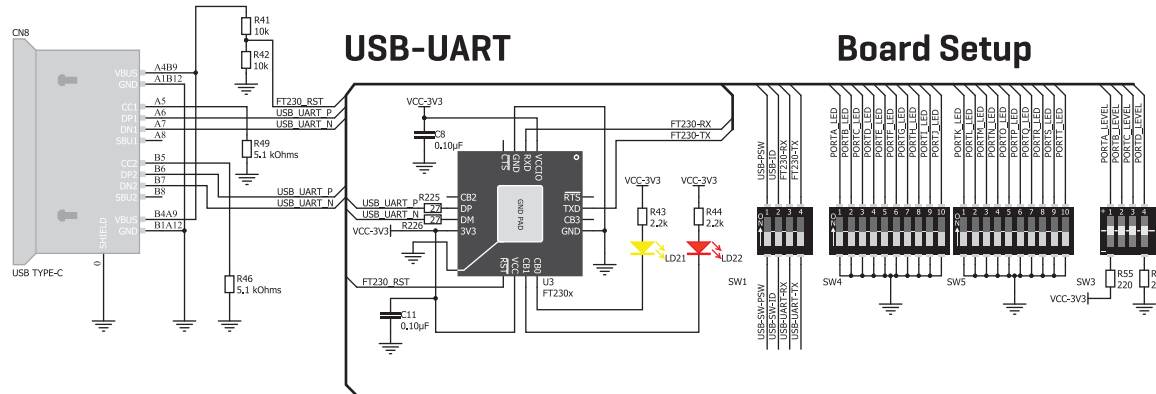

X-ON Electronics

Largest Supplier of Electrical and Electronic Components

Click to view similar products for [Development Boards & Kits - ARM category](#):

Click to view products by [MikroElektronika manufacturer](#):

Other Similar products are found below :

[CWH-CTP-VSPA-YE](#) [CY4541](#) [EVAL-ADUCM320IQSPZ](#) [FRDM-KV31F](#) [POLYPOD-BGA324](#) [POLYPOD-TQ144](#) [POLYPOD-TQ176](#)
[KEA128LEDLIGHTRD](#) [KIT_XMC42_EE1_001](#) [SAFETI-HSK-RM48](#) [LS1024A-RDB](#) [ADM00573](#) [FRDM-KL28Z](#) [PICOHOBBITFL](#)
[MCIMX53-START-R](#) [TWR-K65F180M](#) [KEA128BLDCRD](#) [CC-ACC-MMK-2443](#) [STM8L1528-EVAL](#) [YSPKS5D9E10](#) [YGRPEACHFULL](#)
[TWR-MC-FRDMKE02Z](#) [TWR-K80F150M](#) [CY14NVSRAMKIT-001](#) [EVALSPEAR320CPU](#) [EVB-SCMIMX6SX](#) [MAXWSNENV#](#) [FM0-64L-S6E1C3](#) [MAX32600-KIT#](#) [TMDX570LS04HDK](#) [Z32F3840100KITG](#) [LS1021A-IOT-B](#) [SK-FM3-100PMC-MB9BF516N](#) [TXSD-SV70](#)
[YSTBS3A3E10](#) [YR8A77430HA02BG](#) [STM3240G-USB/NMF](#) [OM13080UL](#) [EVAL-ADUC7120QSPZ](#) [CYDP-KIT-13638](#) [OM13063UL](#)
[ATAVRPARROT](#) [OM13090UL](#) [YSPEHMI1S20](#) [TXSD-SV71](#) [YGRPEACHNORMAL](#) [SK-FM3-176PMC-ETHERNET](#) [HVP-KV11Z75M](#)
[OM13076UL](#) [LX2RDBKIT2-25G](#)