

EVE click™

1. Introduction

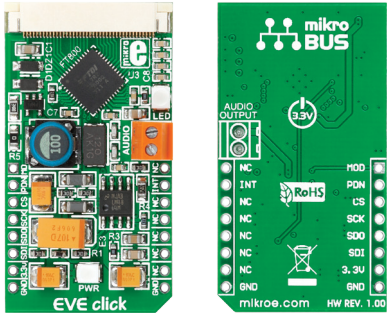

EVE Click™ is an accessory board in **mikroBUS™** form factor. It's a compact and easy solution for adding graphics controller to your design. It features **FT800Q** graphics controller, flat cable connector, **LM4864** audio amplifier, LED diode as well as screw terminals. EVE Click™ communicates with the target board microcontroller via **mikroBUS™** SPI (MISO, MOSI, SCK, CS), INT, RST and AN lines. The board is designed to use 3.3V power supply only. LED diode (GREEN) indicates the presence of power supply.

2. Soldering the headers

Before using your click board™, make sure to solder 1x8 male headers to both left and right side of the board. Two 1x8 male headers are included with the board in the package.

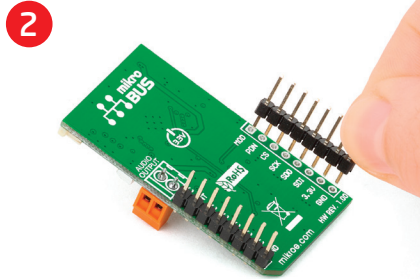
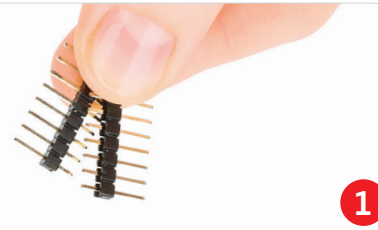

Turn the board upside down so that bottom side is facing you upwards. Place shorter parts of the header pins in both soldering pad locations.

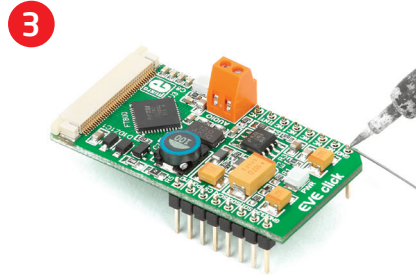

Turn the board upward again. Make sure to align the headers so that they are perpendicular to the board, then solder the pins carefully.

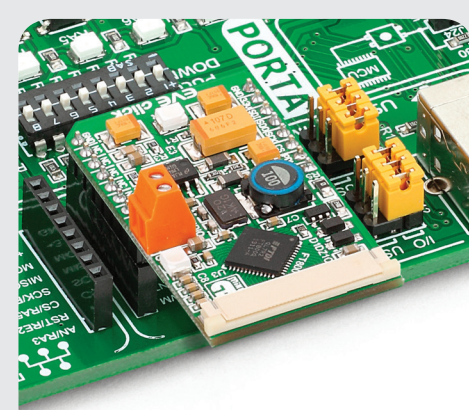

4. Essential features

EVE Click™ with its **FT800Q** IC is embedded video engine controller that combines display, audio and touch-screen features. It has SPI interface to main board microcontroller (up to 30 MHz), video RGB parallel output interface, mono audio channel output with PWM (via screw terminals), sound synthesizer, PWM backlight dimming control, 4-wires touch-screen with touch force sensing, several power modes and many more.

3. Plugging the board in

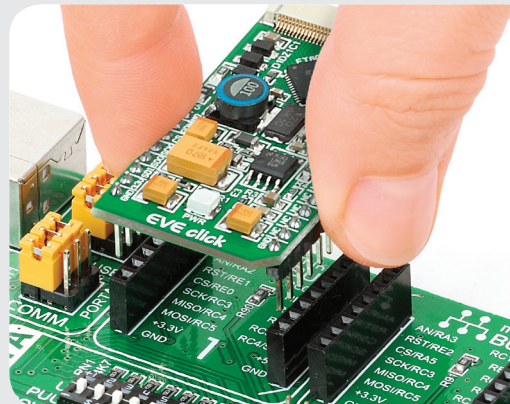

Once you have soldered the headers your board is ready to be placed into desired mikroBUS™ socket. Make sure to align the cut in the lower-right part of the board with the markings on the silkscreen at the mikroBUS™ socket. If all of the pins are aligned correctly, push the board all the way into the socket.

click™
BOARD
www.mikroe.com

EVE click Manual
ver. 1.00



0 100000 023846

5. EVE Click™ Board Schematic

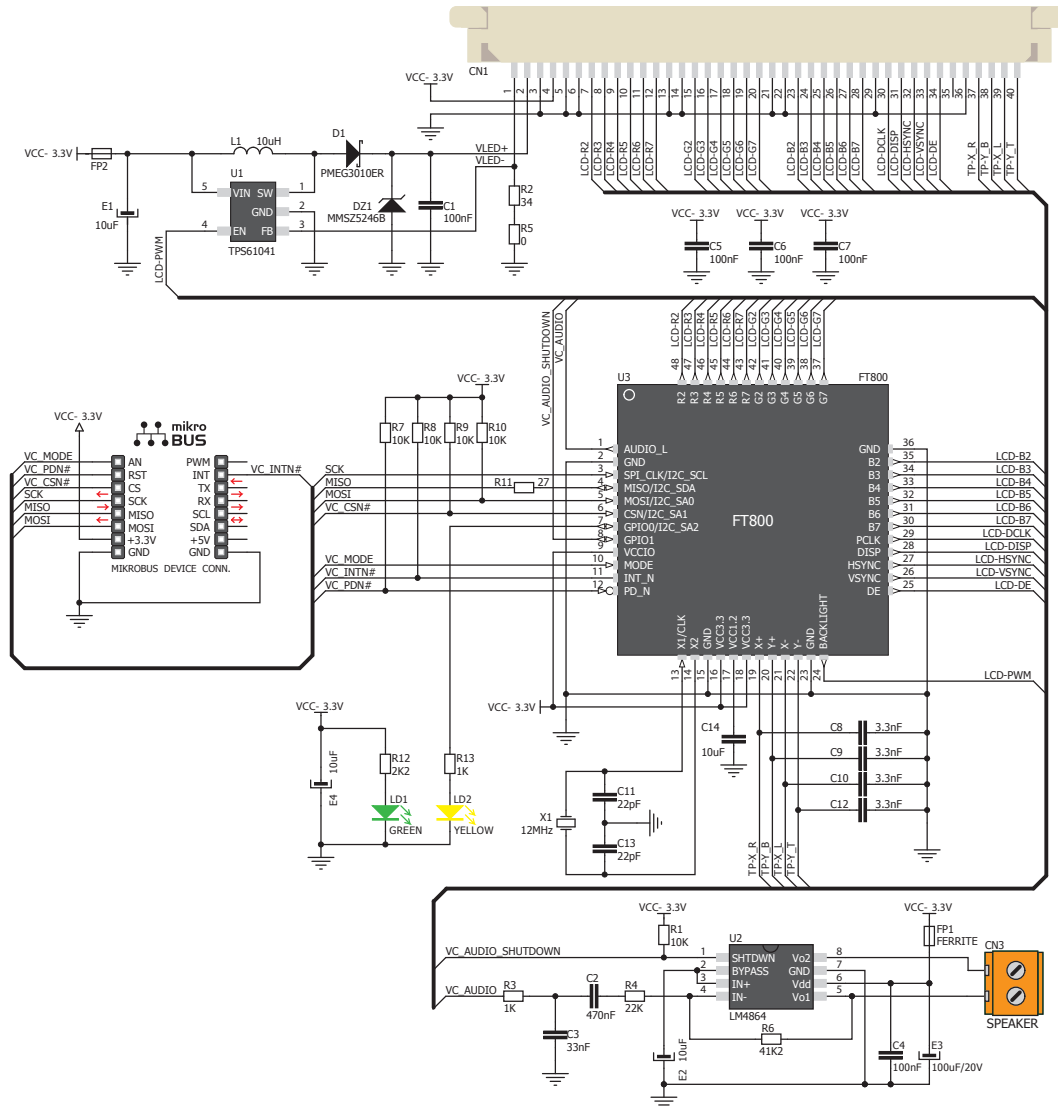

MikroElektronika assumes no responsibility or liability for any errors or inaccuracies that may appear in the present document.

Specification and information contained in the present schematic are subject to change at any time without notice. Copyright © 2013 MikroElektronika. All rights reserved.

6. Flat cable connector

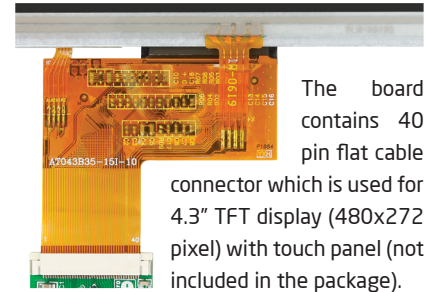

The board contains 40 pin flat cable

connector which is used for 4.3" TFT display (480x272 pixel) with touch panel (not included in the package).

7. Code Examples

Once you have done all the necessary preparations, it's time to get your click board up and running. We have provided the examples for mikroC, mikroBasic and mikroPascal compilers on our **Libstock** website. Just download them and you are ready to start.



8. Support

MikroElektronika offers **Free Tech Support** (www.mikroe.com/esupport) until the end of product lifetime, so if something goes wrong, we are ready and willing to help!

X-ON Electronics

Largest Supplier of Electrical and Electronic Components

Click to view similar products for [Daughter Cards & OEM Boards](#) category:

Click to view products by [MikroElektronika](#) manufacturer:

Other Similar products are found below :

[ADZS-21262-1-EZEXT](#) [27911](#) [SPC56ELADPT144S](#) [TMDXRM46CNCD](#) [DM160216](#) [EV-ADUCM350GPIOHZ](#) [EV-ADUCM350-BIO3Z](#)
[ATSTK521](#) [1130](#) [MA160015](#) [MA180033](#) [MA240013](#) [MA240026](#) [MA320014](#) [MA330014](#) [MA330017](#) [TLK10034SMAEVM](#) [MIKROE-](#)
[2152](#) [MIKROE-2154](#) [MIKROE-2381](#) [TSSOP20EV](#) [DEV-11723](#) [MIKROE-1108](#) [MIKROE-1516](#) [SPS-READER-GEVK](#) [AC244049](#)
[AC244050](#) [AC320004-3](#) [2077](#) [ATSMARTCARD-XPRO](#) [EIC - Q600 -230](#) [ATZB-212B-XPRO](#) [SPC560PADPT100S](#) [SPC560BADPT64S](#)
[MA180018](#) [EIC - Q600 -220](#) [AC164134-1](#) [BOB-12035](#) [BB-BONE-BATT-01](#) [STM8/128-D/RAIS](#) [AC164127-6](#) [AC164127-4](#) [AC164134-3](#)
[AC164156](#) [MA320021](#) [MA320024](#) [DFR0285](#) [DFR0312](#) [DFR0356](#) [MA320023](#)