

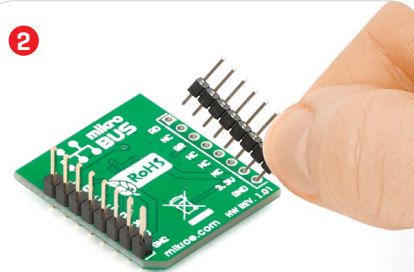

Color click™

2. Soldering the headers

Before using your click™ board, make sure to solder 1x8 male headers to both left and right side of the board. Two 1x8 male headers are included with the board in the package.

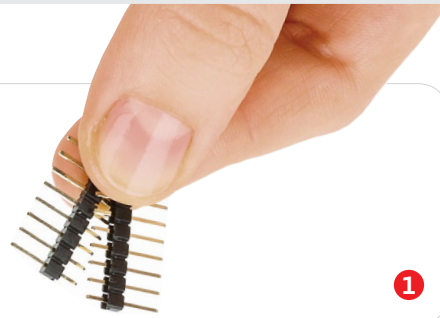

Turn the board upside down so that the bottom side is facing you upwards. Place shorter pins of the header into the appropriate soldering pads.

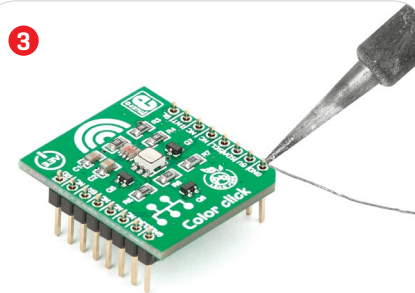

Turn the board upward again. Make sure to align the headers so that they are perpendicular to the board, then solder the pins carefully.

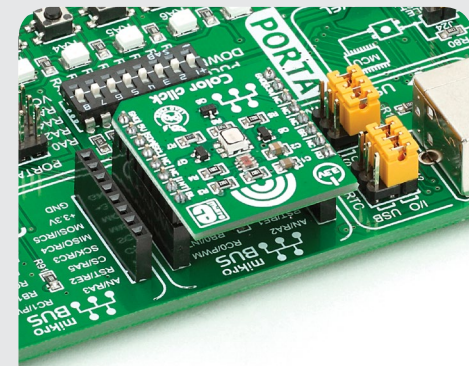

4. Essential features

Color click™ with its **TCS3471** IC is a color light sensor that detects light intensity under a variety of lightning conditions. The **TCS3471** contains 4x4 photodiode array, integrating amplifiers, ADCs, accumulators, clocks, buffers, comparators and state machine. RGB LED is provided to help you illuminate the objects if no other light source is available. This board is ideal for RGB LED backlight control, industrial process control, medical diagnostic and many more.



1. Introduction

Color click™ is an accessory board in **mikroBUS™** form factor. It's a compact and easy solution for adding red, green, blue and clear light sensing to your design. It features **TCS3471** color RGB light-to-digital converter, three NPN resistor-equipped transistors as well as RGB LED. Color click™ communicates with the target board microcontroller via **mikroBUS™** I²C (SDA, SCL), AN, CS, PWM and INT lines. The board is designed to use 3.3V power supply.

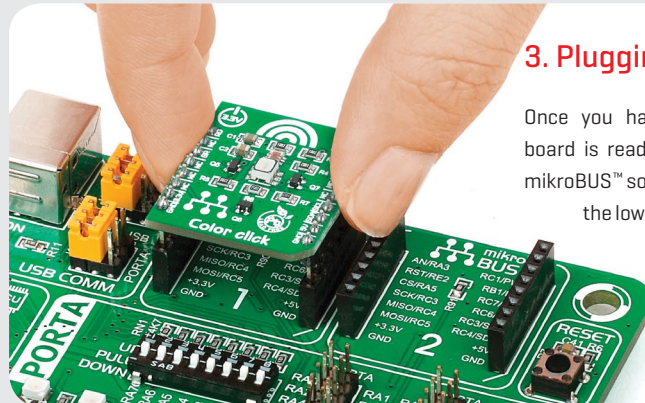

3. Plugging the board in

Once you have soldered the headers your board is ready to be placed into the desired mikroBUS™ socket. Make sure to align the cut in the lower-right part of the board with the markings on the silkscreen at the mikroBUS™ socket. If all the pins are aligned correctly, push the board all the way into the socket.

click™
BOARD
www.mikroe.com



Color click™ manual
ver 1.01a



5. Schematic

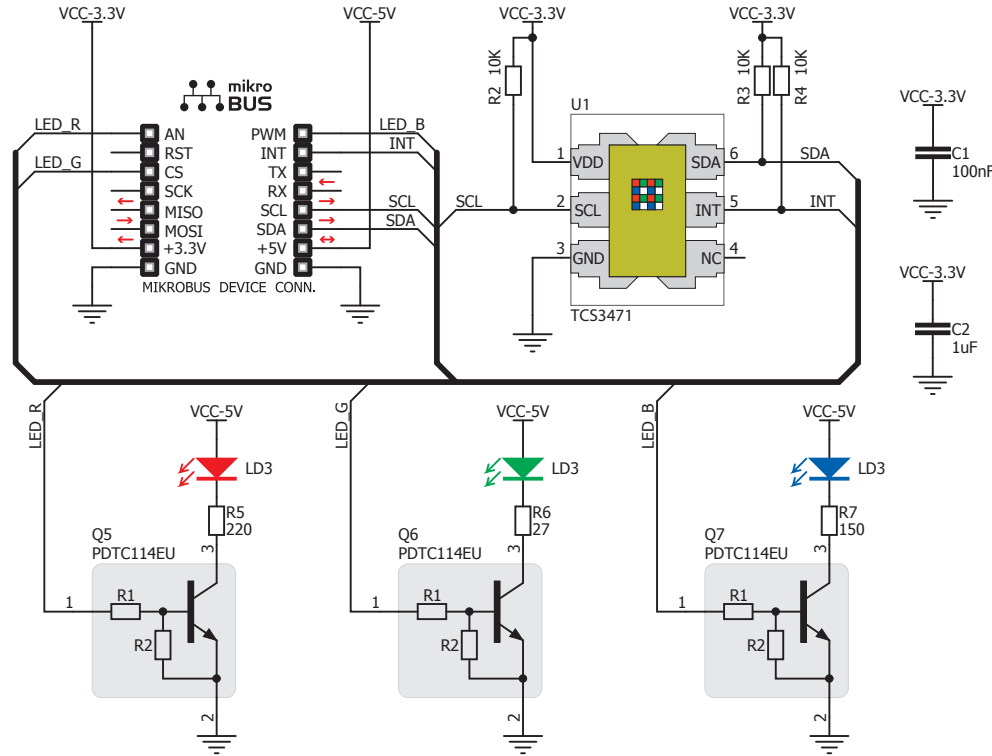

6. Dimensions

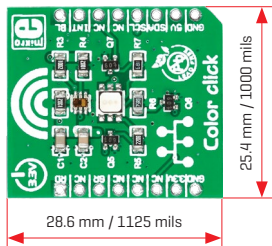

	mm	mils
LENGTH	28.6	1125
WIDTH	25.4	1000
HEIGHT*	3.3	130

* without headers

7. Interrupt line

Color click™ contains separate pin for level-style interrupts. An interrupt is generated when the value of an RGB conversion exceeds either an upper or lower threshold (programmable). In addition, a programmable interrupt persistence feature allows you to determine how many consecutive exceeded thresholds are necessary to trigger an interrupt.

8. Code examples

Once you have done all the necessary preparations, it's time to get your click™ board up and running. We have provided examples for mikroC™, mikroBasic™ and mikroPascal™ compilers on our **Libstock** website. Just download them and you are ready to start.



9. Support

MikroElektronika offers **free tech support** (www.mikroe.com/support) until the end of the product's lifetime, so if something goes wrong, we're ready and willing to help!



10. Disclaimer

MikroElektronika assumes no responsibility or liability for any errors or inaccuracies that may appear in the present document. Specification and information contained in the present schematic are subject to change at any time without notice.

Copyright © 2015 MikroElektronika.
All rights reserved.

X-ON Electronics

Largest Supplier of Electrical and Electronic Components

Click to view similar products for [Optical Sensor Development Tools](#) category:

Click to view products by [MikroElektronika](#) manufacturer:

Other Similar products are found below :

[416015300-3](#) [ISL29102IROZ-EVALZ](#) [TSL2581CS-DB](#) [TMD3700-DB](#) [NANOUSB2.2](#) [MARS1-MAX9295A-GEVK](#) [MARS1-MAX9296B-GEVB](#) [ISL29112IROZ-EVALZ](#) [TCS3430-DB](#) [AR0130CSSM00SPCAH-GEVB](#) [AR0330CM1C00SHAAH3-GEVB](#) [EVALZ-ADPD2212](#) [TMD2772EVM](#) [TMG3993EVM](#) [MIKROE-2103](#) [TSL2672EVM](#) [1384](#) [SEN0043](#) [SEN0162](#) [TMD2771EVM](#) [TMD3782EVM](#) [TSL4531EVM](#) [1918](#) [AS7225 DEMO KIT](#) [SEN0097](#) [SEN0228](#) [AR0134CSSC00SUEAH3-GEVB](#) [AP0100AT2L00XUGAH3-GEVB](#) [725-28915](#) [SEN-14347](#) [PIEZO-01](#) [MIKROE-3330](#) [MT9M114EBLSTCZD3-GEVK](#) [LF-9MT024NV-EVN](#) [SI1102EK](#) [1334](#) [1356](#) [1777](#) [1980](#) [1981](#) [2748](#) [2899](#) [3779](#) [4162](#) [4698](#) [ALS-GEVB](#) [AS7263 DEMO KIT V3.0](#) [AS7261 DEMO KIT V3.0](#) [AS7264N DEMO KIT](#) [AS7265x Demo Kit Housing](#)