

## RS232 click™

### 1. Introduction

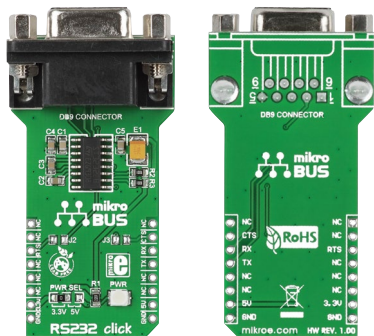

RS232 click™ is a simple solution for adding RS232 serial communications to your design. The board features a standard RS232 DB9 port and a MAX3232 IC, along with a **mikroBUS™** host socket, three jumpers and a power indicator LED. RS232 click™ communicates with the target board through mikroBUS™ RX (RXD), TX (TXD), CS (RTS), and INT (CTS) lines. RS232 click™ is designed to use either a 3.3V or 5V power supply.

### 2. Soldering the headers

Before using your click™ board, make sure to solder 1x8 male headers to both left and right side of the board. Two 1x8 male headers are included with the board in the package.

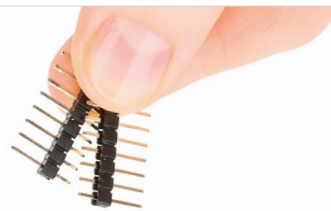

2

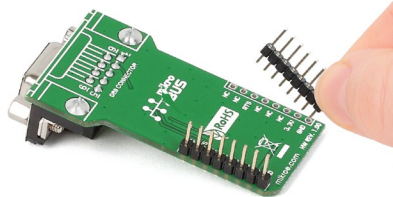

Turn the board upside down so that the bottom side is facing you upwards. Place shorter pins of the header into the appropriate soldering pads.

3

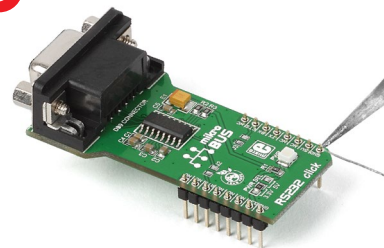

Turn the board upward again. Make sure to align the headers so that they are perpendicular to the board, then solder the pins carefully.



### 4. Essential features

The RS232 DB9 port (9 pins) and the MAX3232 IC constitute a serial communications connector. RS232 is mostly used for industrial machines, networking equipment and scientific instruments, as well as for computer peripherals. The board features two jumper positions to connect RTS (J2) and CTS (J3) lines to the target board (zero-ohm SMD jumpers not provided in the package).

### 3. Plugging the board in

Once you have soldered the headers your board is ready to be placed into the desired mikroBUS™ socket. Make sure to align the cut in the lower-right part of the board with the markings on the silkscreen at the mikroBUS™ socket. If all the pins are aligned correctly, push the board all the way into the socket.

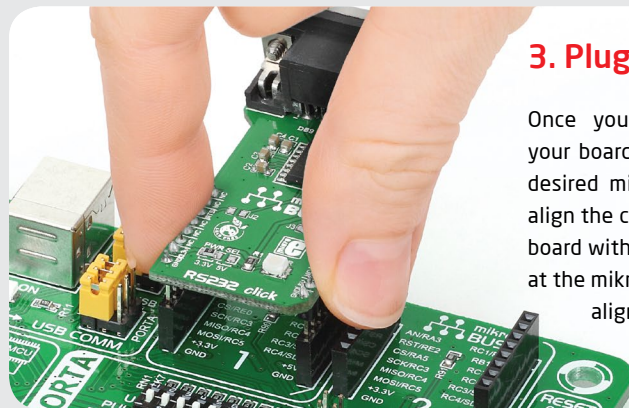

click™  
BOARD  
[www.mikroe.com](http://www.mikroe.com)

RS232 click v100 Manual  
ver. 1.00



## 5. RS232 click™ Board Schematic

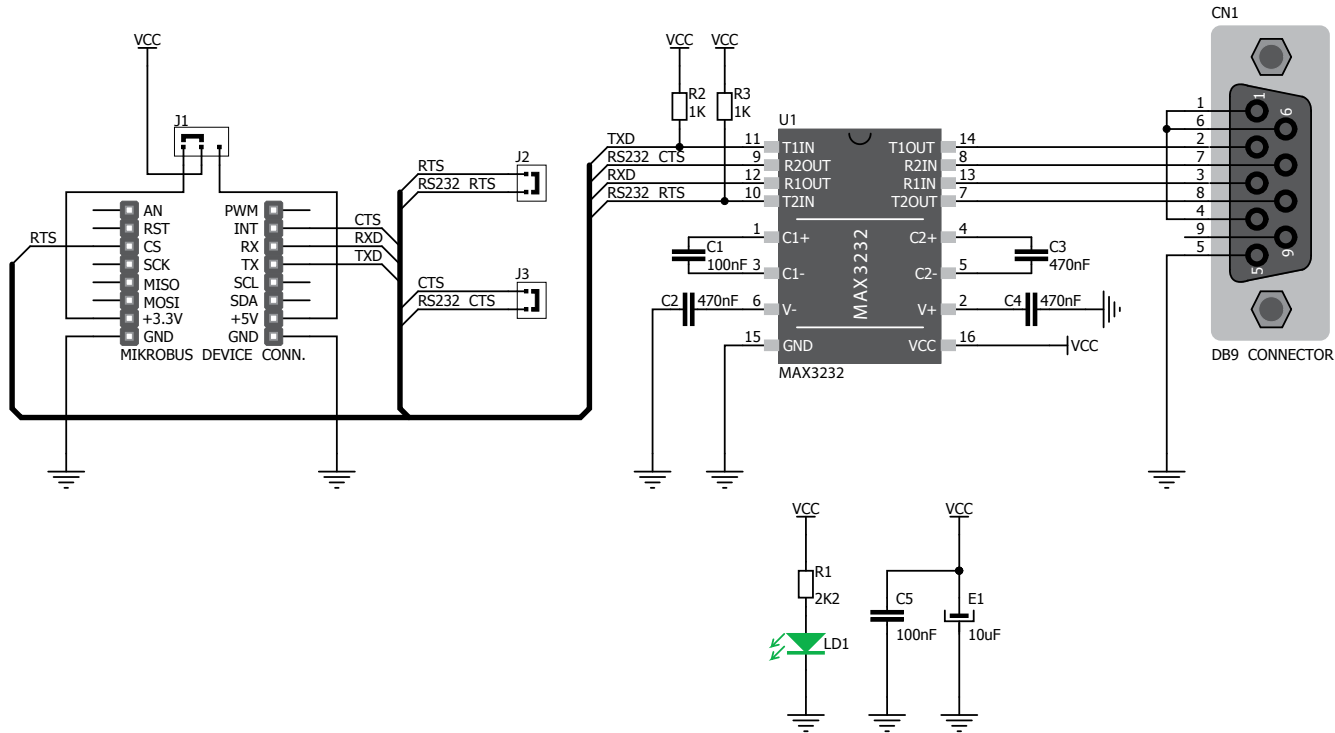

## 6. SMD Jumpers

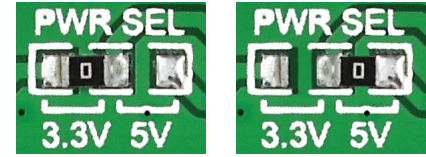

To switch between 3.3V and 5V power supplies use the PWR SEL zero-ohm SMD jumper. By default it's soldered in the 3.3V position.

## 7. Code Examples

Once you have done all the necessary preparations, it's time to get your click™ board up and running. We have provided examples for mikroC™, mikroBasic™ and mikroPascal™ compilers on our **Libstock** website. Just download them and you are ready to start.



## 8. Support

MikroElektronika offers **Free Tech Support** ([www.mikroe.com/support/](http://www.mikroe.com/support/)) until the end of the product's lifetime, so if something goes wrong, we're ready and willing to help!

## X-ON Electronics

Largest Supplier of Electrical and Electronic Components

*Click to view similar products for [Interface Development Tools](#) category:*

*Click to view products by [MikroElektronika](#) manufacturer:*

Other Similar products are found below :

[ADP5585CP-EVALZ](#) [CHA2066-99F](#) [AS8650-DB](#) [MLX80104 TESTINTERFACE](#) [416100120-3](#) [XR18910ILEVB](#) [XR21B1421IL28-0A-EVB](#) [TW-DONGLE-USB](#) [EVAL-ADM2491EEBZ](#) [MAXREFDES23DB#](#) [MAX13235EEVKIT](#) [DFR0257](#) [XR22404CG28EVB](#) [ZLR964122L](#) [ZLR88822L](#) [EVK-U23-01S](#) [EVK-W262U-00](#) [DC327A](#) [PIM511](#) [PIM536](#) [PIM517](#) [DEV-17512](#) [STR-FUSB3307MPX-PPS-GEVK](#) [MAXREFDES177#](#) [EVAL-ADM2567EEBZ](#) [ZSSC3240KIT](#) [MAX9121EVKIT](#) [PIM532](#) [ZSC31010KITV2P1](#) [UMFT4233HPEV](#) [LVDS-18B-EVK](#) [XR20M1170G16-0A-EB](#) [XR20M1170G16-0B-EB](#) [XR20M1170G24-0B-EB](#) [XR20M1172G28-0A-EB](#) [XR20M1172G28-0B-EB](#) [SI871XSOIC8-KIT](#) [1764](#) [1833](#) [1862](#) [EVB-USB82514](#) [ATA6628-EK](#) [ATA6631-EK](#) [EVAL-CN0313-SDPZ](#) [2264](#) [MCP23X17EV](#) [PS081-EVA-HR MODULE](#) [237](#) [SMA2RJ45EVK/NOPB](#) [FR12-0002](#)