

UV click™

## 2. Soldering the headers

Before using your click™ board, make sure to solder 1x8 male headers to both left and right side of the board. Two 1x8 male headers are included with the board in the package.

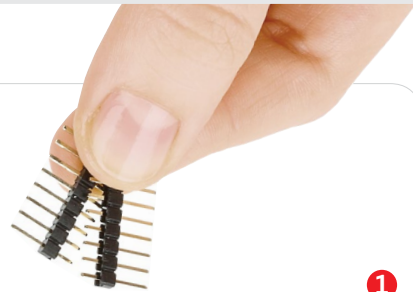

1

## 1. Introduction

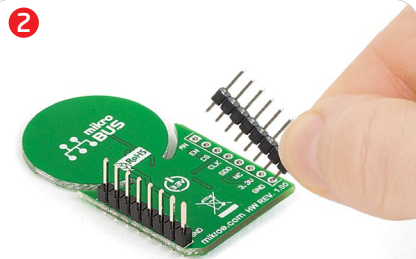
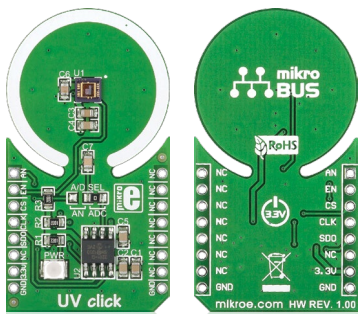

Turn the board upside down so that the bottom side is facing you upwards. Place shorter pins of the header into the appropriate soldering pads.

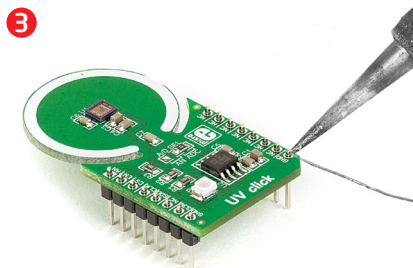
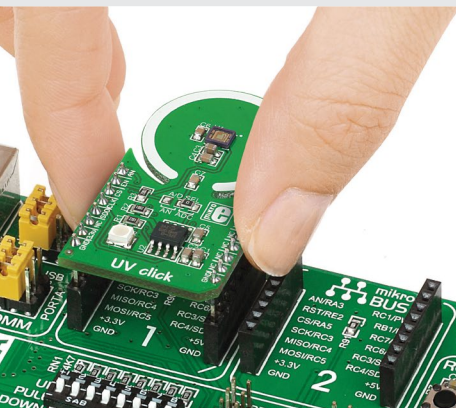

Turn the board upward again. Make sure to align the headers so that they are perpendicular to the board, then solder the pins carefully.

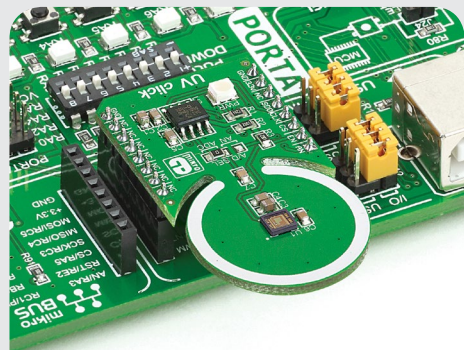

## 4. Essential features

With UV click™, you can measure ultraviolet light intensity both indoors and outdoors. The photodiode on the ML511 IC is sensitive to UV-A (365-315 nm) and UV-B (315-280 nm) rays. You can use UV click™ to design devices that protect the user against excessive sun exposure, or for industrial purposes where UV light is used for sterilization. When using UV click™, be careful not to rub or press the surface of the ML511 IC.

UV click™ is a simple solution for adding an ultraviolet light sensor to your design. It carries the ML511 IC UV sensor with analog voltage output and a MCP3201 ADC. UV click™ can output either analog or digital signals (determined by the position of the A/D SEL jumper). Therefore, it communicates with the target board either through mikroBUS™ SPI (CS, SCK, MISO), or AN lines; additionally, the sensor can be enabled or disabled from the MCU through the RST (EN) pin. UV click™ uses a 3.3V power supply.

## 3. Plugging the board in

Once you have soldered the headers your board is ready to be placed into the desired mikroBUS™ socket. Make sure to align the cut in the lower-right part of the board with the markings on the silkscreen at the mikroBUS™ socket. If all the pins are aligned correctly, push the board all the way into the socket.

click™  
BOARD  
www.mikroe.com

UV click™ manual  
ver. 1.00



## 5. UV click™ board schematic

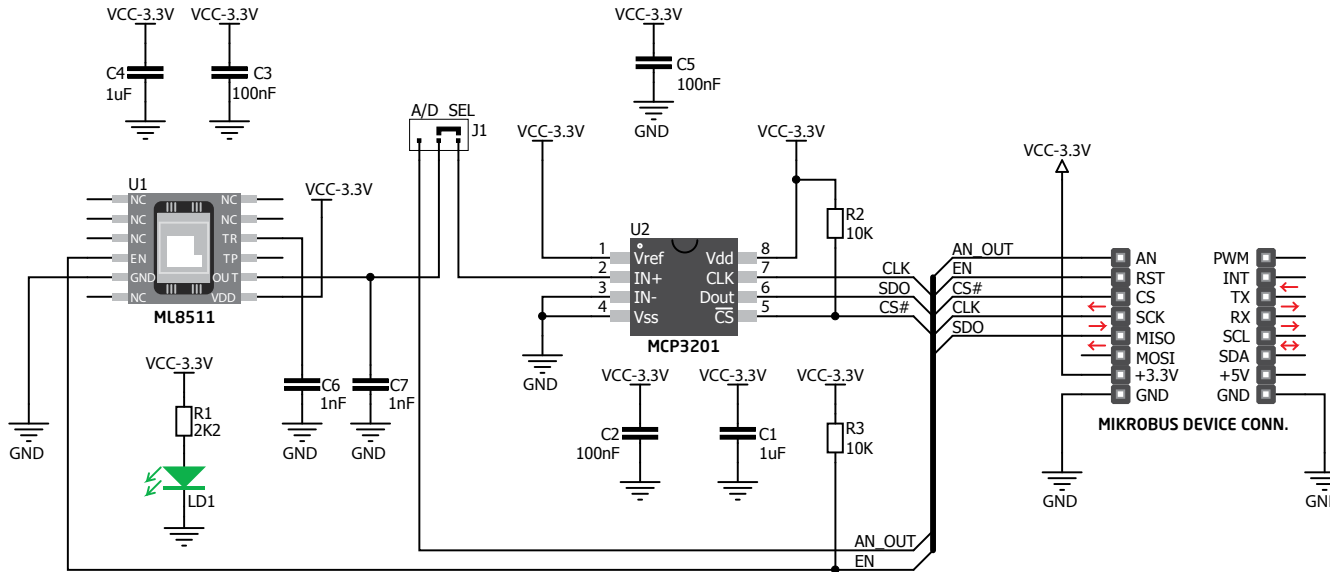

## 6. A/D SEL jumpers

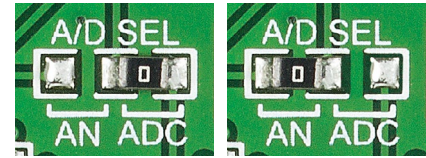

To switch between analog and digital output options, resolder the onboard **J1** SMD jumper (zero-ohm resistor). By default, it's soldered in the ADC position.

## 7. Code examples

Once you have done all the necessary preparations, it's time to get your click™ board up and running. We have provided examples for mikroC™, mikroBasic™ and mikroPascal™ compilers on our **Libstock** website. Just download them and you are ready to start.



## 8. Support

MikroElektronika offers **free tech support** ([www.mikroe.com/support](http://www.mikroe.com/support)) until the end of the product's lifetime, so if something goes wrong, we're ready and willing to help!

## X-ON Electronics

Largest Supplier of Electrical and Electronic Components

*Click to view similar products for [Optical Sensor Development Tools](#) category:*

*Click to view products by [MikroElektronika](#) manufacturer:*

Other Similar products are found below :

[416015300-3](#) [ISL29102IROZ-EVALZ](#) [TSL2581CS-DB](#) [TMD3700-DB](#) [NANOUSB2.2](#) [MARS1-MAX9295A-GEVK](#) [MARS1-MAX9296B-GEVB](#) [ISL29112IROZ-EVALZ](#) [TCS3430-DB](#) [AR0130CSSM00SPCAH-GEVB](#) [AR0330CM1C00SHAAH3-GEVB](#) [EVALZ-ADPD2212](#) [TMD2772EVM](#) [TMG3993EVM](#) [MIKROE-2103](#) [TSL2672EVM](#) [1384](#) [SEN0043](#) [SEN0162](#) [TMD2771EVM](#) [TMD3782EVM](#) [TSL4531EVM](#) [1918](#) [AS7225 DEMO KIT](#) [SEN0097](#) [SEN0228](#) [AR0134CSSC00SUEAH3-GEVB](#) [AP0100AT2L00XUGAH3-GEVB](#) [725-28915](#) [SEN-14347](#) [PIEZO-01](#) [MIKROE-3330](#) [MT9M114EBLSTCZD3-GEVK](#) [LF-9MT024NV-EVN](#) [SI1102EK](#) [1334](#) [1356](#) [1777](#) [1980](#) [1981](#) [2748](#) [2899](#) [3779](#) [4162](#) [4698](#) [ALS-GEVB](#) [AS7263 DEMO KIT V3.0](#) [AS7261 DEMO KIT V3.0](#) [AS7264N DEMO KIT](#) [AS7265x Demo Kit Housing](#)