

NFC Tag click™

1. Introduction

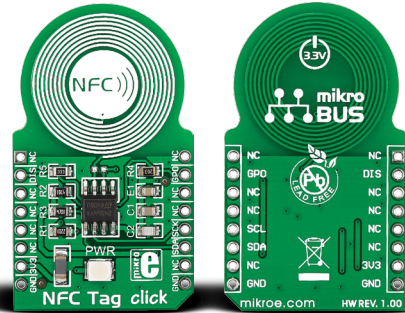

NFC Tag click™ carries an **M24SR64 NFC/RFID tag IC** with a dual interface and **8KB of high-reliability EEPROM** built-in. The RF protocol is compatible with both **NFC Forum Type 4 Tag and ISO/IEC 14443 Type A**, so there's three ways to operate it: 1) from an I2C interface; 2) by a 13.56 MHz RFID reader; or 3) from an NFC-enabled smartphone, tablet, and similar device. NFC Tag click™ communicates with the target board through **mikroBUS™ I2C (SCL, SDA), INT and RST** lines. It uses a 3.3V power supply only.

2. Soldering the headers

Before using your click™ board, make sure to solder 1x8 male headers to both left and right side of the board. Two 1x8 male headers are included with the board in the package.

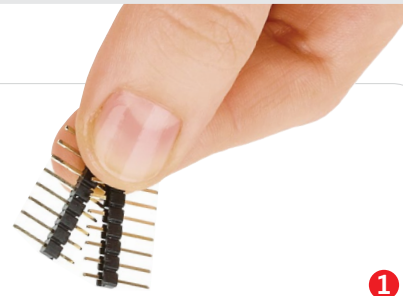

1

2

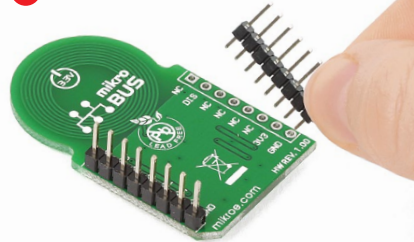

Turn the board upside down so that the bottom side is facing you upwards. Place shorter pins of the header into the appropriate soldering pads.

3

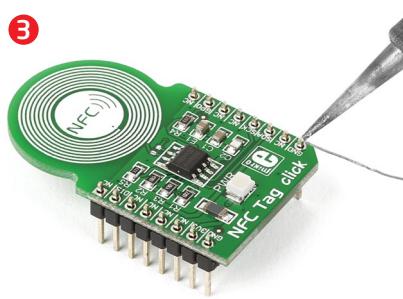

Turn the board upward again. Make sure to align the headers so that they are perpendicular to the board, then solder the pins carefully.

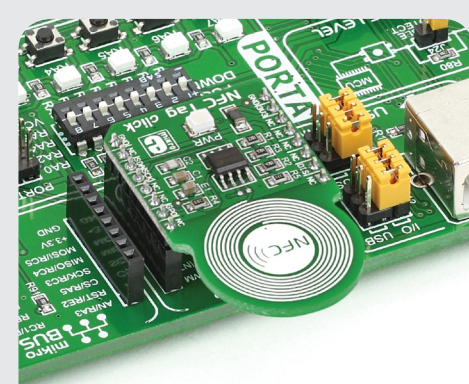

4. Essential features

NFC (near field communications) is a radio standard for small data volumes and over limited ranges (with the particular PCB antenna on NFC Tag click™, you'll have a **range of about 3cm**). NFC also allows two-way communication. These features make NFC the preferred standard for mobile payments, simple Bluetooth pairing and other connection handovers, or for social networking applications, like exchanging vcards.

3. Plugging the board in

Once you have soldered the headers your board is ready to be placed into the desired mikroBUS™ socket. Make sure to align the cut in the lower-right part of the board with the markings on the silkscreen at the mikroBUS™ socket. If all the pins are aligned correctly, push the board all the way into the socket.

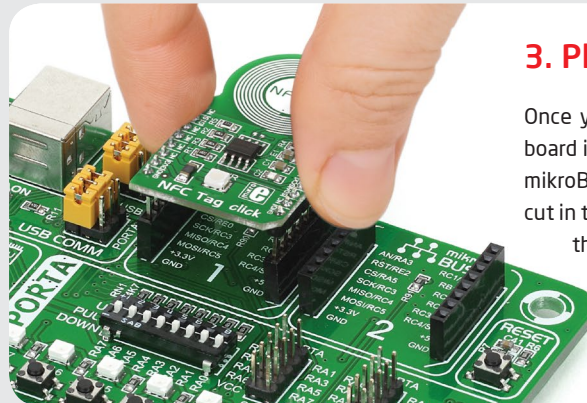

click™
BOARD
www.mikroe.com

NFC Tag click™ manual
ver. 1.00



0 100000 027561

5. NFC Tag click™ board schematic

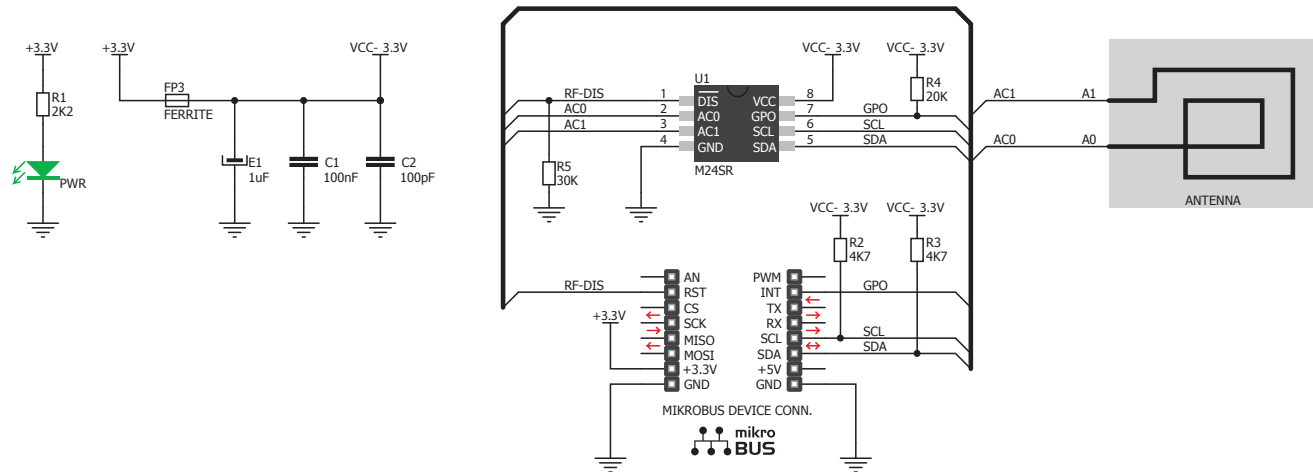

MikroElektronika assumes no responsibility or liability for any errors or inaccuracies that may appear in the present document. Specification and information contained in the present schematic are subject to change at any time without notice. Copyright © 2014 MikroElektronika. All rights reserved.

6. Additional resources



NFCWorld+ keeps an up-to-date, accurate and exhaustive list of NFC supported phones:

www.nfcworld.com/nfc-phones-list/

Also, STMicroelectronics provides a free Android DEMO app for NFC supported phones. Search for "M24SR DEMO" on Google Play.

7. Code examples

Once you have done all the necessary preparations, it's time to get your click™ board up and running. We have provided examples for mikroC™, mikroBasic™ and mikroPascal™ compilers on our **Libstock** website. Just download them and you are ready to start.



8. Support

MikroElektronika offers **free tech support** (www.mikroe.com/support) until the end of the product's lifetime, so if something goes wrong, we're ready and willing to help!



X-ON Electronics

Largest Supplier of Electrical and Electronic Components

Click to view similar products for [RFID Transponder Tools](#) category:

Click to view products by [MikroElektronika](#) manufacturer:

Other Similar products are found below :

[SP-MX-08-HF-M2](#) [V700-A43 10M](#) [WF-SM-30](#) [V700-A44 20M](#) [V680-A81](#) [V680-A60 2M](#) [WS02-CFSC1-EV3](#) [V680-A60 5M](#) [V680-HAM91](#) [V680-A60 10M](#) [V700-A46 50M](#) [V680S-HMD66-ETN](#) [MEDP-MF-RFID-R10](#) [ST25-TAG-BAG-U](#) [MIKROE-3644](#) [MIKROE-2395](#) [1482](#) [MIKROE-2462](#) [2800](#) [2802](#) [X-NUCLEO-NFC05A1](#) [359](#) [360](#) [361](#) [362](#) [363](#) [365](#) [3781](#) [789](#) [884](#) [4032](#) [4033](#) [4034](#) [4043](#) [4429](#) [4701](#) [AS3980-QF_DK_ST](#) [AS3930 DEMOSYSTEM](#) [AS3953-DK-TAGS](#) [ATARFID-EK1](#) [ATARFID-EK2](#) [EVB90109](#) [MIKROE-3659](#) [MIKROE-3971](#) [MIKROE-4208](#) [MIKROE-1434](#) [MIKROE-1475](#) [MIKROE-1726](#) [MIKROE-262](#) [MIKROE-4309](#)