

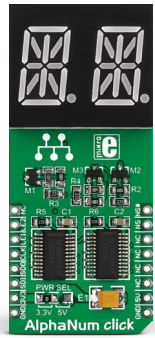

AlphaNum click™



1. Introduction

AlphaNum click™ is a simple solution for adding **14-segment alphanumeric displays** to your device. The board carries two **TLC5926** 16-bit Constant-Current LED sink Drivers as well as a dual character LED 14-segment display. AlphaNum click™ communicates with the target board through **mikroBUS™** RST, CS, SCK, MISO, MOSI, PWM and INT pins (marked here as LE2, LE1, CLK, DOUT, DIN, NUMSEL# and NUMSEL respectively). The board is designed to use either a 3.3V or 5V power supply.

2. Soldering the headers

Before using your click™ board, make sure to solder 1x8 male headers to both left and right side of the board. Two 1x8 male headers are included with the board in the package.

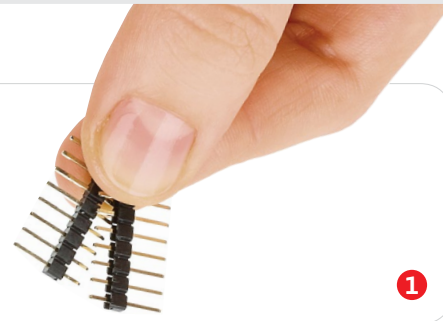

1

2

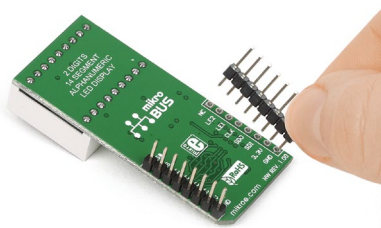

Turn the board upside down so that the bottom side is facing you upwards. Place shorter pins of the header into the appropriate soldering pads.

3

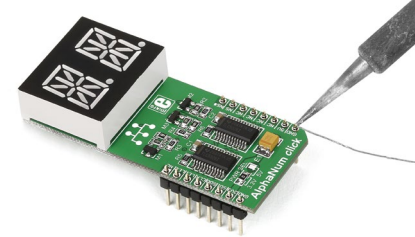

Turn the board upward again. Make sure to align the headers so that they are perpendicular to the board, then solder the pins carefully.

3. Plugging the board in

Once you have soldered the headers your board is ready to be placed into the desired mikroBUS™ socket. Make sure to align the cut in the lower-right part of the board with the markings on the silkscreen at the mikroBUS™ socket. If all the pins are aligned correctly, push the board all the way into the socket.

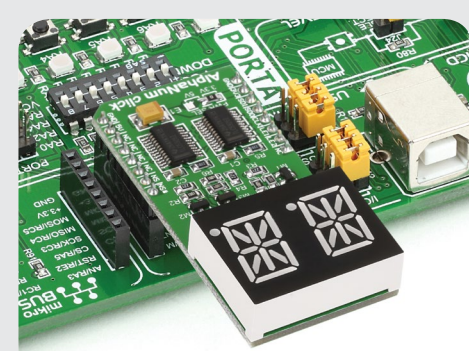
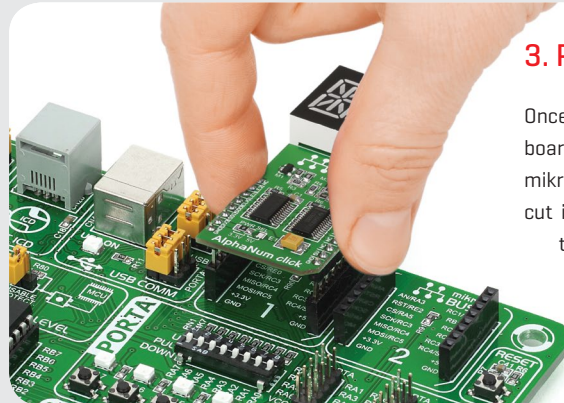

4. Essential features

While a standard 7-segment display is sufficient only for displaying digits, a 14-segment display (also known as a starburst display) is necessary for legibly rendering the ISO basic Latin alphabet. The dual character display onboard AlphaNum click™ also contain two commas (decimal points if used for digits) as additional segments. The two TLC5926 ICs contain 16-bit shift registers and data latches to convert serial input data into parallel output format.

click™
BOARD
www.mikroe.com



AlphaNum click™ manual
ver 1.00



0100000075739

5. Schematic

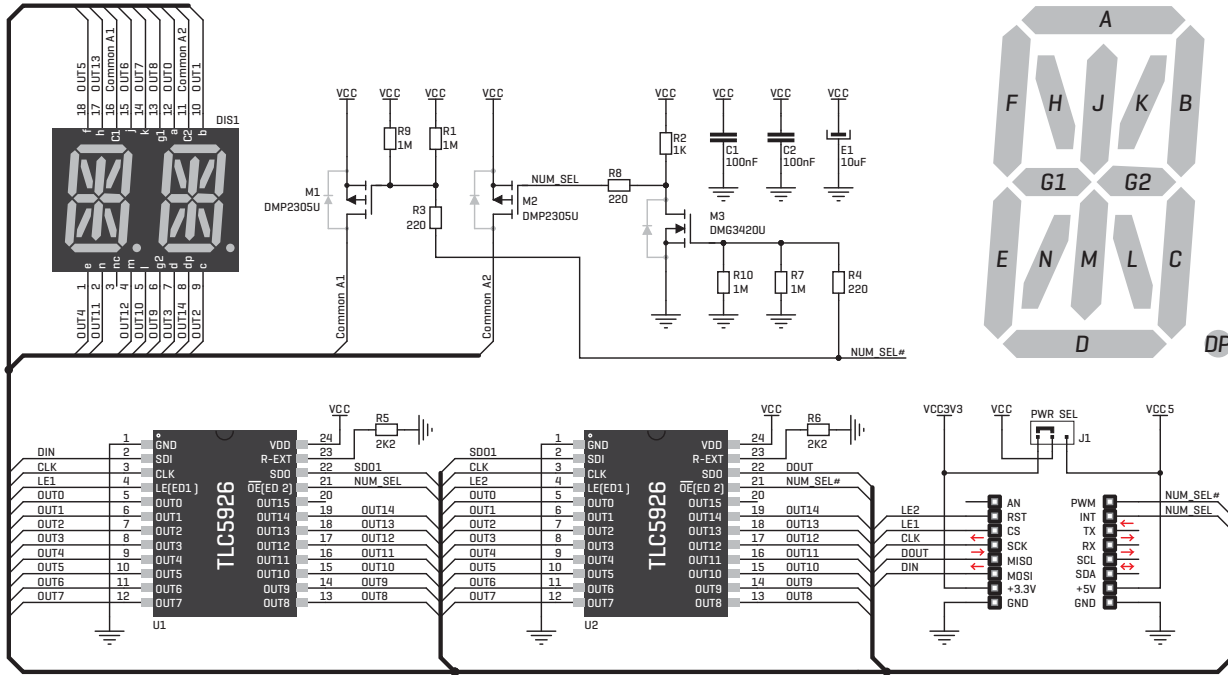

6. Dimensions

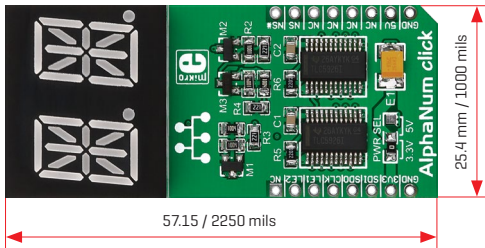

	mm	mils
LENGTH	57.15	2250
WIDTH	25.4	1000
HEIGHT*	11	433

* without headers

7. SMD jumper



AlphaNum click™ carries a single zero-ohm SMD jumper used to select between 3.3V or 5V I/O voltage levels. The jumper is soldered in the 3.3V position by default.

8. Code examples

Once you have done all the necessary preparations, it's time to get your click™ board up and running. We have provided examples for mikroC™, mikroBasic™ and mikroPascal™ compilers on our **Libstock** website. Just download them and you are ready to start.



9. Support

MikroElektronika offers **free tech support** [www.mikroe.com/support] until the end of the product's lifetime, so if something goes wrong, we're ready and willing to help!



10. Disclaimer

MikroElektronika assumes no responsibility or liability for any errors or inaccuracies that may appear in the present document. Specification and information contained in the present schematic are subject to change at any time without notice.

Copyright © 2015 MikroElektronika.
All rights reserved.

X-ON Electronics

Largest Supplier of Electrical and Electronic Components

Click to view similar products for [Display Development Tools](#) category:

Click to view products by [MikroElektronika](#) manufacturer:

Other Similar products are found below :

[KIT 60121-3](#) [S5U13U11P00C100](#) [121CBL02-RPK](#) [KIT 60145-3](#) [S5U13748P00C100](#) [DFR0413](#) [DLPLCR90EVM](#) [DLPLCR50XEVM](#)
[MAX20069EVKIT#](#) [KIT95000-3](#) [LCD-16396](#) [PIM370](#) [1109](#) [MCIMX-LVDS1](#) [MIKROE-2449](#) [MIKROE-2453](#) [131](#) [DEV-13628](#) [1590](#)
[MIKROE-2269](#) [1601](#) [1770](#) [1947](#) [1983](#) [1987](#) [2050](#) [2218](#) [2260](#) [2345](#) [2418](#) [2423](#) [2454](#) [2455](#) [2478](#) [2674](#) [SK-220RD-PI](#) [FIT0477](#) [333](#) [334](#)
[TE-M321-SDK](#) [DFR0428](#) [cs-epapersk-03](#) [338](#) [DEV-14442](#) [FIT0478](#) [cs-paperino-01](#) [OM-E-OLE](#) [ALTHSMCMIPILCD](#) [ASD2421-R](#)
[TDP0500T800480PCAP](#)