

SRAM click

2. Soldering the headers

Before using your click board™, make sure to solder 1x8 male headers to both left and right side of the board. Two 1x8 male headers are included with the board in the package.

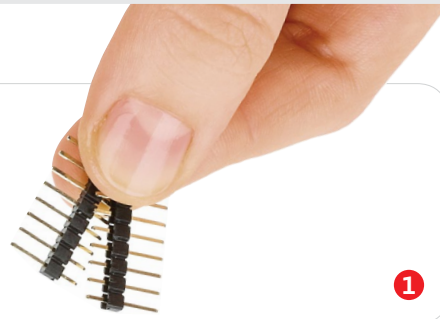

1

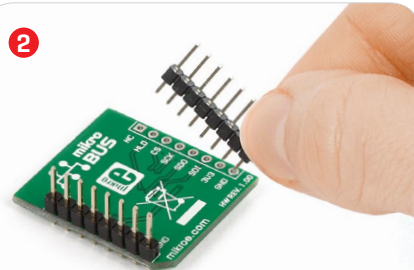

Turn the board upside down so that the bottom side is facing you upwards. Place shorter pins of the header into the appropriate soldering pads.

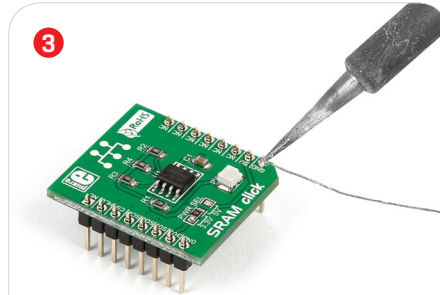

Turn the board upward again. Make sure to align the headers so that they are perpendicular to the board, then solder the pins carefully.

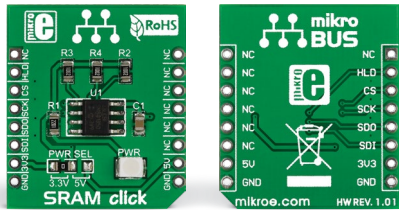

1. Introduction

SRAM click lets you add 1 Mbit of additional SRAM memory to your devices, via the **23LC1024** chip. The board communicates with the target MCU through the mikroBUS™ SPI interface [MISO, MOSI, SCK, CS] with additional HOLD functionality provided through the default mikroBUS™ RST pin. SRAM click is designed to use either a 3.3V or 5V power supply.

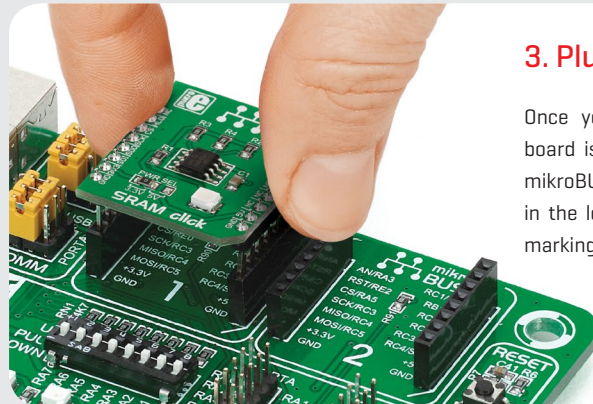

3. Plugging the board in

Once you have soldered the headers your board is ready to be placed into the desired mikroBUS™ socket. Make sure to align the cut in the lower-right part of the board with the markings on the silkscreen at the mikroBUS™ socket. If all the pins are aligned correctly, push the board all the way into the socket.

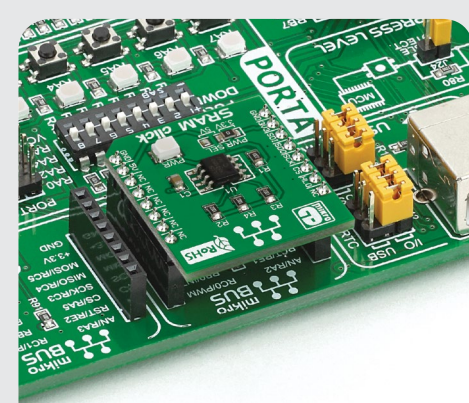

4. Essential features

The 23LC1024 IC organizes the memory in 8-bit instruction registers and 32-byte pages. Three operating modes for reading and writing data are available: byte, page, and sequential [the last one allows read/write for entire memory array]. The clock rate for all three modes is up to 20MHz. The HOLD pin, when pulled low, suspends data transmission mid-sequence [without causing the reset of the entire sequence].

click
BOARD™
www.mikroe.com



SRAM click manual
ver 1.01



010000081969

5. Schematic

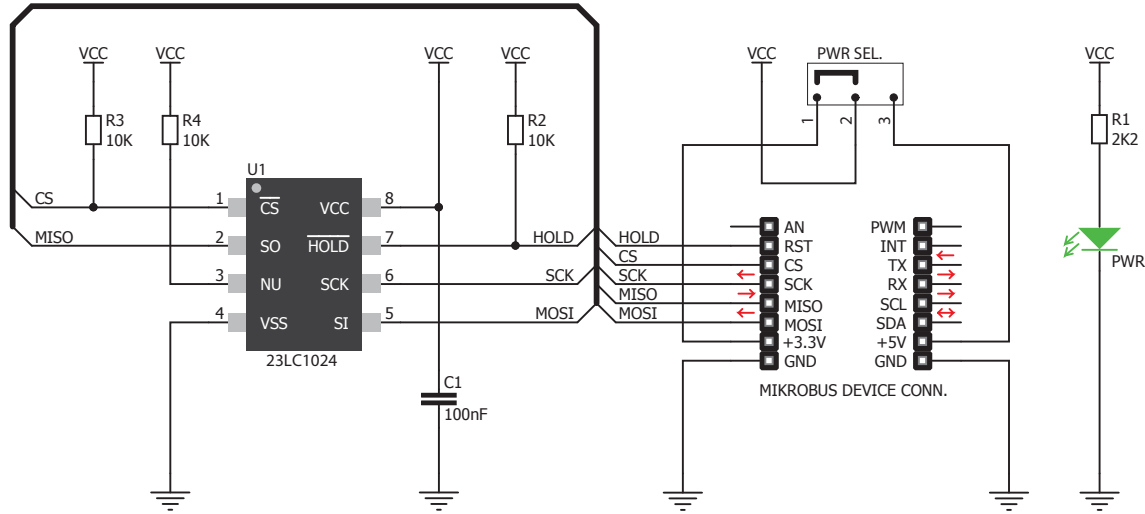

6. Dimensions

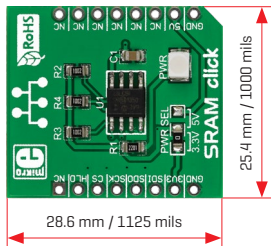

	mm	mils
LENGTH	28.6	1125
WIDTH	25.4	1000
HEIGHT*	3.3	130

* without headers

7. SMD jumpers

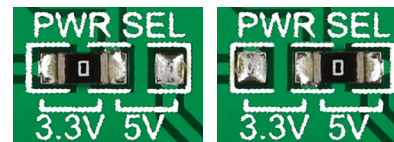

SRAM click features an SMD jumper [zero ohm resistor] that let's you switch between a 3.3V or a 5V power supply.

8. Code examples

Once you have done all the necessary preparations, it's time to get your click board™ up and running. We have provided examples for mikroC™, mikroBasic™ and mikroPascal™ compilers on our **Libstock** website. Just download them and you are ready to start.



9. Support

MikroElektronika offers **free tech support** [www.mikroe.com/support] until the end of the product's lifetime, so if something goes wrong, we're ready and willing to help!



10. Disclaimer

MikroElektronika assumes no responsibility or liability for any errors or inaccuracies that may appear in the present document. Specification and information contained in the present schematic are subject to change at any time without notice.

Copyright © 2015 MikroElektronika.
All rights reserved.

X-ON Electronics

Largest Supplier of Electrical and Electronic Components

Click to view similar products for [Memory IC Development Tools](#) category:

Click to view products by [MikroElektronika](#) manufacturer:

Other Similar products are found below :

[HLDC-DDR3-A](#) [254](#) [HLDC-DDR4-4GB-A](#) [1569](#) [1897](#) [AC500100](#) [AC243008](#) [AC243009](#) [1895](#) [254](#) [2574](#) [4682](#) [4718](#) [4719](#) [939](#) [HLDC-DDR4-A](#) [HLDC-QDRIV-A](#) [ASX00008](#) [CY15FRAMKIT-002](#) [CF02-F9-ILAT06-M01](#) [USB02-U9-RBB06-M01](#) [USB06-U8-RB1Q03-M01](#) [AC243003](#) [AC243005-1](#) [AC500101](#) [DM160232](#) [DV243003](#) [MIKROE-3641](#) [MIKROE-3762](#) [MIKROE-3780](#) [MIKROE-3817](#) [MIKROE-4067](#) [MIKROE-4129](#) [MIKROE-4178](#) [MIKROE-4232](#) [MIKROE-4293](#) [MIKROE-4421](#) [MIKROE-4440](#) [MIKROE-1199](#) [MIKROE-1200](#) [MIKROE-1486](#) [MIKROE-1902](#) [MIKROE-1909](#) [MIKROE-1989](#) [MIKROE-2267](#) [MIKROE-2374](#) [MIKROE-2536](#) [MIKROE-2914](#) [MIKROE-3](#) [MIKROE-3104](#)