

10DOF click

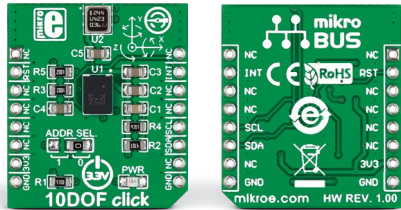

1. Introduction

10DOF click is a mikroBUS™ add-on board for enhancing hardware prototypes with 10DOF functionality [10 degrees of freedom]. The click board carries two modules from Bosch: BNO055, a 9-axis absolute orientation sensor and BMP180, a digital pressure sensor. 10DOF click communicates with the target board MCU through the mikroBUS™ I2C interface [SCL, SDA], with additional functionality provided by INT and RST pins. Designed to use a 3.3V power supply only.

2. Soldering the headers

Before using your click board™, make sure to solder 1x8 male headers to both left and right side of the board. Two 1x8 male headers are included with the board in the package.

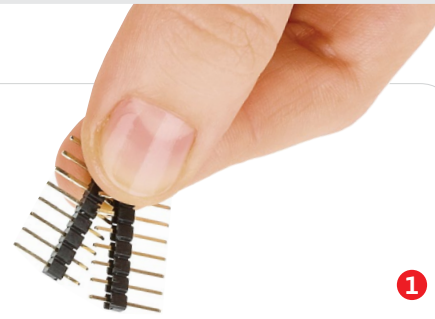

1



Turn the board upside down so that the bottom side is facing you upwards. Place shorter pins of the header into the appropriate soldering pads.

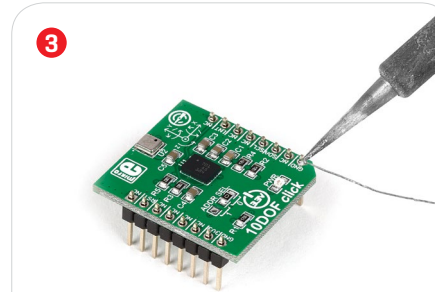

Turn the board upward again. Make sure to align the headers so that they are perpendicular to the board, then solder the pins carefully.

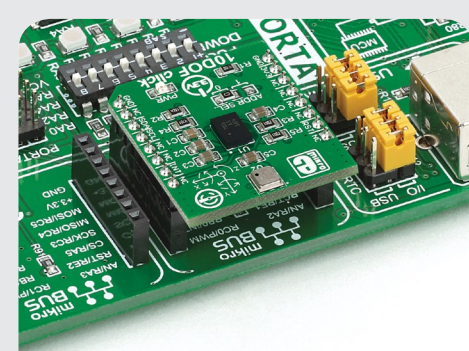

4. Essential features

The BNO055 contains 3 sensors: a 3-axis 16-bit gyroscope, a 14-bit 3-axis accelerometer, and a 3-axis magnetometer. Together with the BMP180 digital pressure sensor which can be used to assess altitude, 10DOF click is a complete inertial-measurement unit which can be used to enhance GPS navigation [with dead reckoning], but also in robotics, fitness devices, game controllers, tablets and other devices that need to be aware of their position in space.

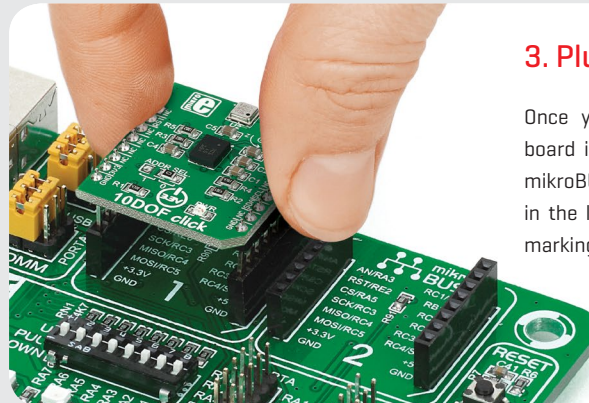

3. Plugging the board in

Once you have soldered the headers your board is ready to be placed into the desired mikroBUS™ socket. Make sure to align the cut in the lower-right part of the board with the markings on the silkscreen at the mikroBUS™ socket. If all the pins are aligned correctly, push the board all the way into the socket.

click
BOARDS™
www.mikroe.com

10DOF click Manual v100



0100000095560

5. Schematic

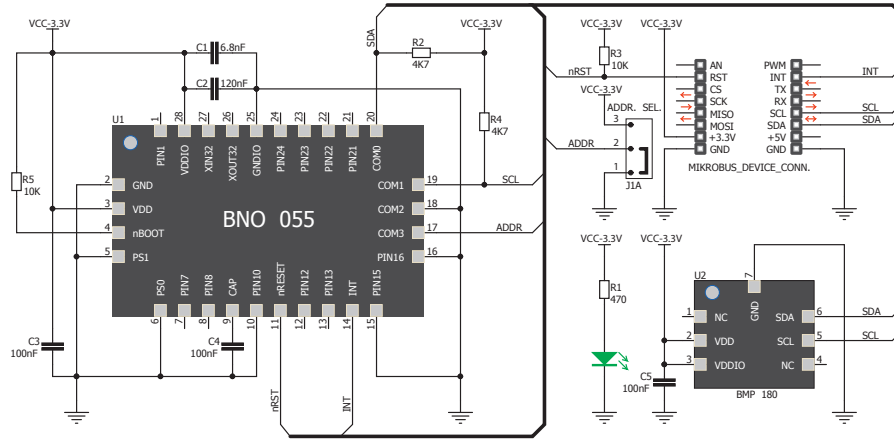

6. Dimensions

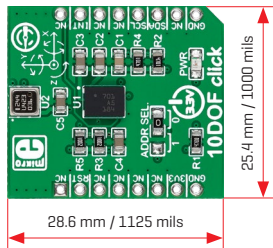

| | mm | mils |
|---------|------|------|
| LENGTH | 28.6 | 1125 |
| WIDTH | 25.4 | 1000 |
| HEIGHT* | 3.3 | 130 |

* without headers

7. Alternative select



The ADDR SEL jumper is for specifying the I2C address of the BNO055 sensor.

8. Code examples

Once you have done all the necessary preparations, it's time to get your click board™ up and running. We have provided examples for mikroC™, mikroBasic™ and mikroPascal™ compilers on our **Libstock** website. Just download them and you are ready to start.



9. Support

MikroElektronika offers **free tech support** [www.mikroe.com/support] until the end of the product's lifetime, so if something goes wrong, we're ready and willing to help!



10. Disclaimer

MikroElektronika assumes no responsibility or liability for any errors or inaccuracies that may appear in the present document. Specification and information contained in the present schematic are subject to change at any time without notice.

Copyright © 2016 MikroElektronika.
All rights reserved.

X-ON Electronics

Largest Supplier of Electrical and Electronic Components

Click to view similar products for [Multiple Function Sensor Development Tools](#) category:

Click to view products by [MikroElektronika](#) manufacturer:

Other Similar products are found below :

[MAXWSNENV#](#) [STEVAL-MKIT01V1](#) [KT-O2-25%-TB200A-E](#) [KT-TVOC-200-TB200A](#) [KT-NmHc-200-TB200A](#) [SEN0344](#) [PIM520](#)
[PIM518](#) [PIM519](#) [PIM502](#) [EVAL-AD7746HDZ](#) [AS7022-EVALKIT](#) [ALTEHTG2SMIP](#) [OB1203SD-U-EVK](#) [MIKROE-4265](#) [ARG-LDKT](#)
[EV_ICG-20660L](#) [GX-F12A-P](#) [GX-F15A](#) [GX-F6A-P](#) [GX-F8B](#) [GX-H12A-P](#) [GX-H15AI-P](#) [GX-H6A-P](#) [1093](#) [MIKROE-2455](#) [MIKROE-2458](#)
[MIKROE-2507](#) [MIKROE-2508](#) [MIKROE-2516](#) [MIKROE-2529](#) [1458](#) [MIKROE-1628](#) [176](#) [189](#) [1893](#) [2106](#) [ATQT4-XPRO](#) [GX-F12AI-P](#)
[GX-F15A-P](#) [GX-F8A-P](#) [GX-FL15B-P](#) [GX-H15A-P](#) [GX-H6AI-P](#) [GX-H8A](#) [GX-H8AI-P](#) [GX-H8A-P](#) [GX-F15AI-P](#) [GX-FL15A-P](#) [GX-H15A](#)