

MINI-M4™

development board for MSP432

The whole MSP432 development board fitted
in DIP40 form factor, containing powerful
MSP432P401R microcontroller.

TO OUR VALUED CUSTOMERS

I want to express my thanks to you for being interested in our products and for having confidence in MikroElektronika.

The primary aim of our company is to design and produce high quality electronic products and to constantly improve the performance thereof in order to better suit your needs.

A white, handwritten signature in cursive script, appearing to read 'N. Matic', is positioned on the right side of the page.

Nebojsa Matic
General Manager

Table of Contents

Introduction to MINI-M4 for MSP432	4
Key features	4
System specifications	5
1. Programming with mikroBootloader	6
step 1 - Connecting MINI-M4 for MSP432	6
step 2 - Browsing for .HEX file	7
step 3 - Selecting .HEX file	7
step 4 - Uploading .HEX file	8
step 5 - Finish upload	9
2. Schematic	10
3. Pinout	11
4. Dimensions	12

Introduction to MINI-M4 for MSP432

Miniature and powerful development tool designed to work as stand alone device or as MCU card in DIP40 socket.

MINI-M4 for MSP432 is pre programmed with USB UART Bootloader so it is not necessary to have external programmer.

If there is need for external programmers (mikroProg™ or ST-LINK V2) attach it to MINI-M4 for STM32 via pads marked with TCK/SWC, TMS/SWD, INTO, INT1.

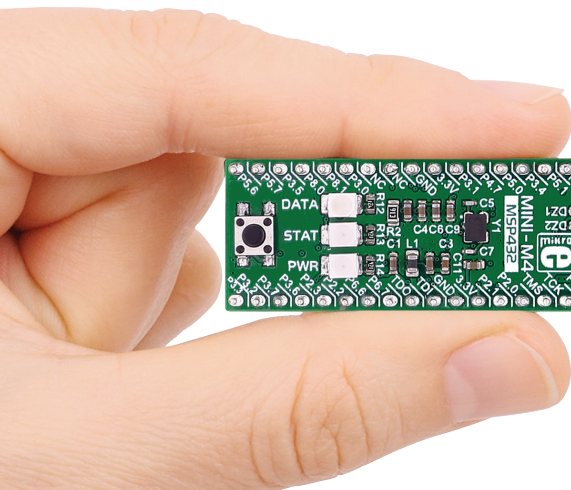

Key features

- 01 Connection pads
- 02 micro USB connector
- 03 DATA LED
- 04 STAT LED
- 05 POWER supply LED
- 06 Reset button
- 07 Power supply regulator
- 08 MSP432P401RIRGC microcontroller
- 09 32.768kHz Crystal oscillator
- 10 48 MHz Crystal oscillator

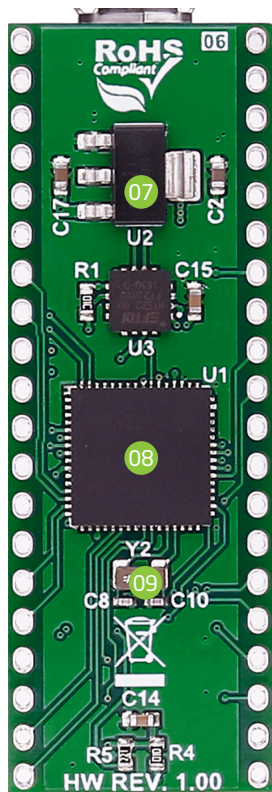
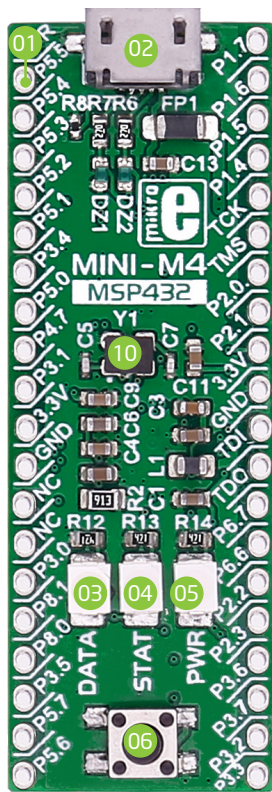

System specifications



power supply

3.3V via pads or 5V via USB



power consumption

depends on MCU state (max current into 3.3V pad is 300mA)



board dimensions

50.8 x 17.78mm (2 x 0.7")



weight

~6g (0.013 lbs)

1. Programming with mikroBootloader

You can program the microcontroller with the bootloader which is pre-programmed into the device by default. To transfer .hex file from a PC to MCU you need bootloader software (**mikroBootloader USB UART**) which can be downloaded from:

<https://download.mikroe.com/examples/starter-boards/mini/msp432/mini-m4-msp432-bootloader-v242.zip>

After the software is downloaded unzip it to the desired location and start mikroBootloader USB UART software.

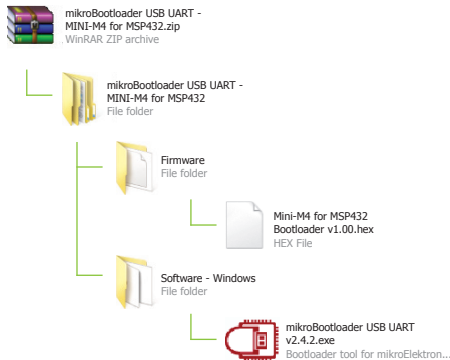

step 1 - Connecting MINI-M4

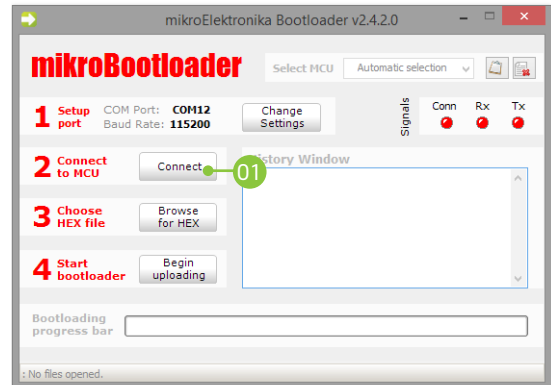

Figure 1-1: USB UART mikroBootloader

- 01 To start, connect the USB cable, or if already connected press the **Reset** button on your MINI-M4 board. Click the **Connect** button within 5s to enter the bootloader mode, otherwise existing microcontroller program will execute.

step 2 - Browsing for .HEX file



Figure 1-2: Browse for HEX

- 01 Click the **"Browse for HEX"** button and from a pop-up window (**Figure 1-3**) choose the .HEX file which will be uploaded to MCU memory.

step 3 - Selecting .HEX file

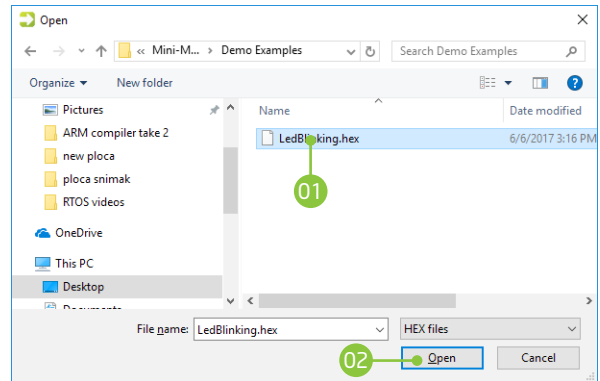

Figure 1-3: Selecting HEX

- 01 Select .HEX file using open dialog window.
- 02 Click **Open**.

step 4 - Uploading .HEX file

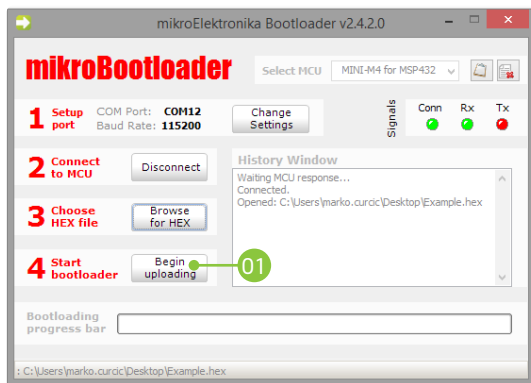

Figure 1-4: Begin uploading

01 To start .HEX file bootloading click the **Begin uploading** button.

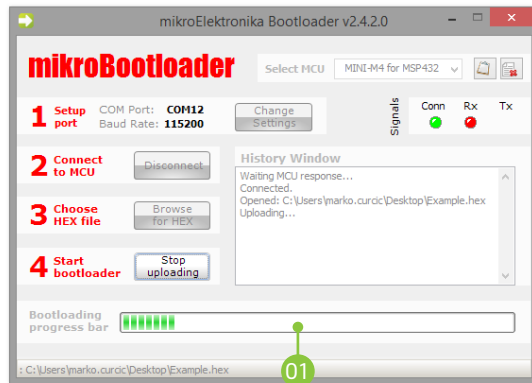

Figure 1-5: Progress bar

01 You can monitor .HEX file uploading via progress bar

step 5 - Finish upload

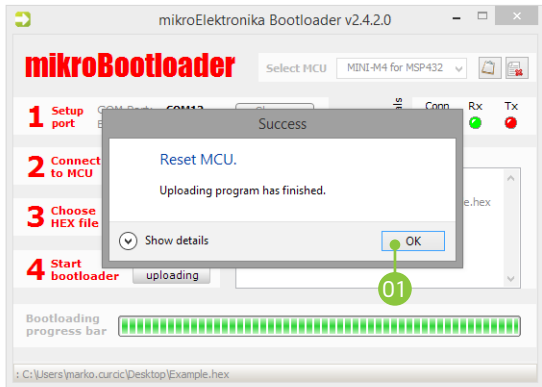

Figure 1-6: Restarting MCU

- 01** Click **OK** after uploading is finished and wait for 5 seconds. Board will automatically reset and your new program will execute.

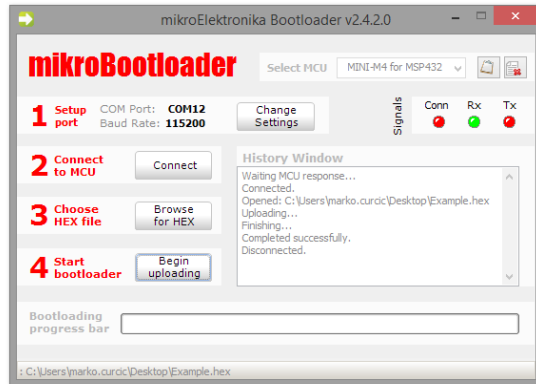
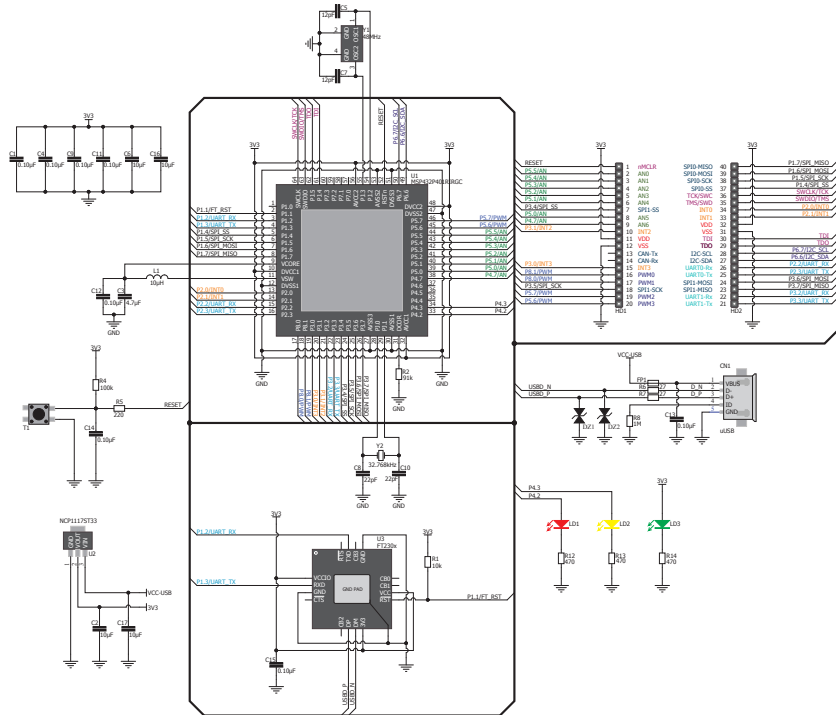
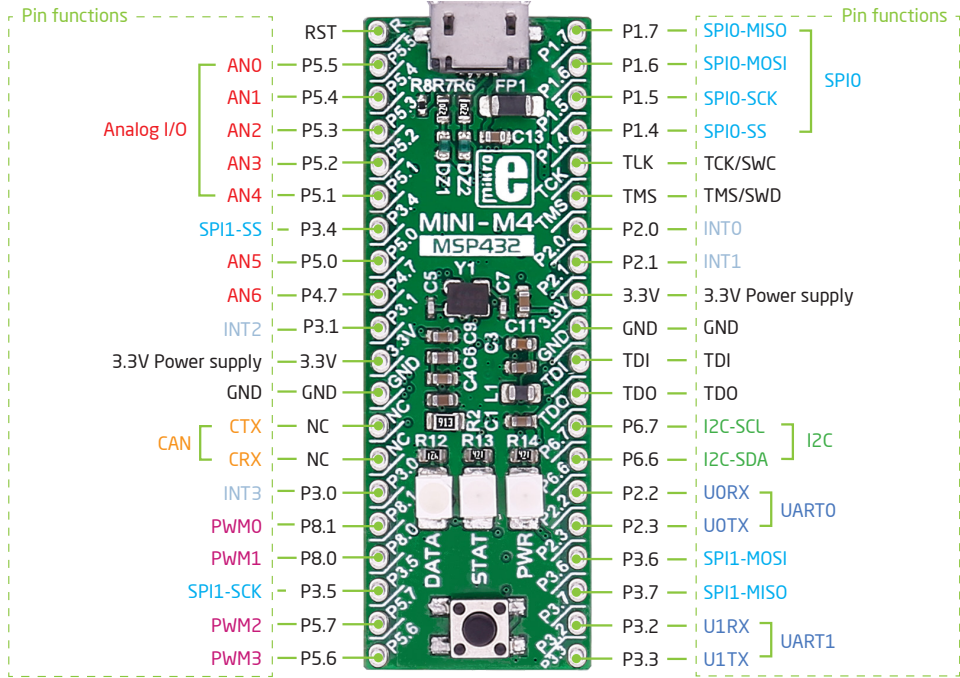

Figure 1-7: mikroBootloader ready for next job

2. Schematic



3. Pinout



■ Analog Lines
 ■ Interrupt Lines
 ■ SPI Lines
 ■ I2C Lines
 ■ UART lines
 ■ CAN lines
 ■ PWM lines

4. Dimensions

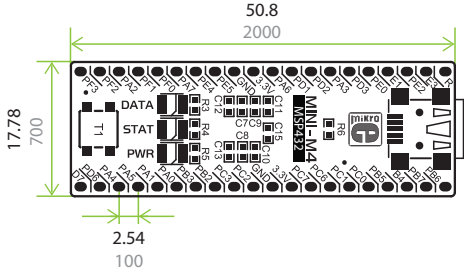

Legend
— mm
— mils

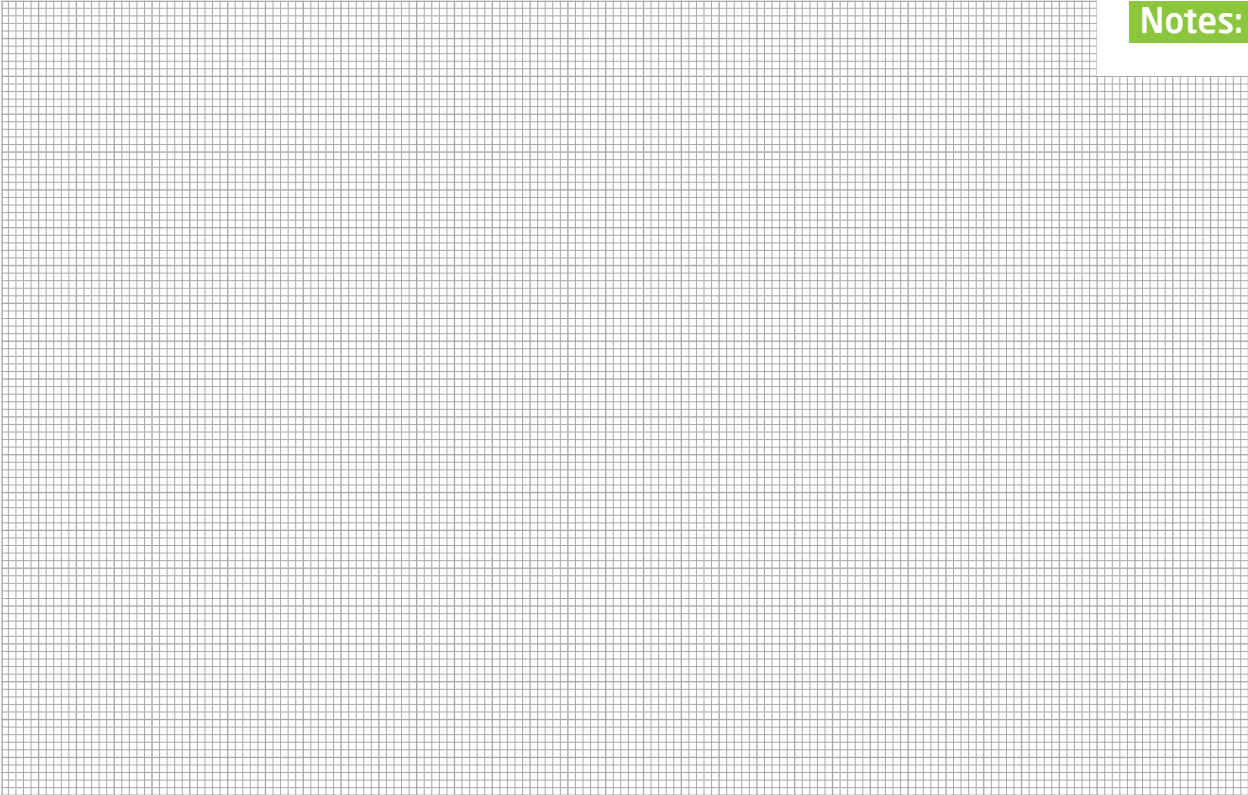

Notes:

DISCLAIMER

All the products owned by MikroElektronika are protected by copyright law and international copyright treaty. Therefore, this manual is to be treated as any other copyright material. No part of this manual, including product and software described herein, may be reproduced, stored in a retrieval system, translated or transmitted in any form or by any means, without the prior written permission of MikroElektronika. The manual PDF edition can be printed for private or local use, but not for distribution. Any modification of this manual is prohibited.

MikroElektronika provides this manual 'as is' without warranty of any kind, either expressed or implied, including, but not limited to, the implied warranties or conditions of merchantability or fitness for a particular purpose.

MikroElektronika shall assume no responsibility or liability for any errors, omissions and inaccuracies that may appear in this manual. In no event shall MikroElektronika, its directors, officers, employees or distributors be liable for any indirect, specific, incidental or consequential damages (including damages for loss of business profits and business information, business interruption or any other pecuniary loss) arising out of the use of this manual or product, even if MikroElektronika has been advised of the possibility of such damages. MikroElektronika reserves the right to change information contained in this manual at any time without prior notice, if necessary.

HIGH RISK ACTIVITIES

The products of MikroElektronika are not fault - tolerant nor designed, manufactured or intended for use or resale as on - line control equipment in hazardous environments requiring fail - safe performance, such as in the operation of nuclear facilities, aircraft navigation or communication systems, air traffic control, direct life support machines or weapons systems in which the failure of Software could lead directly to death, personal injury or severe physical or environmental damage ('High Risk Activities'). MikroElektronika and its suppliers specifically disclaim any expressed or implied warranty of fitness for High Risk Activities.

TRADEMARKS

The MikroElektronika name and logo, the MikroElektronika logo, mikroC™, mikroBasic™, mikroPascal™, MINI™, EasyMX PRO™, mikroBUS™, click™ boards, mikroProg™, and mikromedia™ are trademarks of MikroElektronika. All other trademarks mentioned herein are property of their respective companies. All other product and corporate names appearing in this manual may or may not be registered trademarks or copyrights of their respective companies, and are only used for identification or explanation and to the owners' benefit, with no intent to infringe.



If you want to learn more about our products, please visit our website at www.mikroe.com

If you are experiencing some problems with any of our products or just need additional information, please place your ticket at helpdesk.mikroe.com

If you have any questions, comments or business proposals,
do not hesitate to contact us at office@mikroe.com

X-ON Electronics

Largest Supplier of Electrical and Electronic Components

Click to view similar products for [Development Boards & Kits - ARM category](#):

Click to view products by [MikroElektronika manufacturer](#):

Other Similar products are found below :

[SAFETI-HSK-RM48](#) [PICOHOBBITFL](#) [CC-ACC-MMK-2443](#) [EVALSPEAR320CPU](#) [TMDX570LS04HDK](#) [TXSD-SV70](#) [TXSD-SV71](#)
[YGRPEACHNORMAL](#) [PICODWARFFL](#) [YR8A77450HA02BG](#) [3580](#) [32F3348DISCOVERY](#) [ATTINY1607](#) [CURIOSITY NANO](#)
[PIC16F15376](#) [CURIOSITY NANO BOARD](#) [PIC18F47Q10](#) [CURIOSITY NANO](#) [VISIONSTK-6ULL V.2.0](#) [80-001428](#) [DEV-17717](#)
[EAK00360](#) [YR0K77210B000BE](#) [RTK7EKA2L1S00001BE](#) [SLN-VIZN-IOT](#) [LV18F V6 DEVELOPMENT SYSTEM](#) [READY FOR AVR](#)
[BOARD](#) [READY FOR PIC BOARD](#) [READY FOR PIC \(DIP28\)](#) [AVRPLC16 V6 PLC SYSTEM](#) [MIKROLAB FOR AVR XL](#) [MIKROLAB](#)
[FOR PIC L](#) [MINI-AT BOARD - 5V](#) [MINI-M4 FOR STELLARIS](#) [MOD-09.Z](#) [BUGGY + CLICKER 2 FOR PIC32MX + BLUETOOT](#) [1410](#)
[LETS MAKE PROJECT PROGRAM. RELAY PIC](#) [LETS MAKE - VOICE CONTROLLED LIGHTS](#) [LPC-H2294](#) [DSPIC-READY2 BOARD](#)
[DSPIC-READY3 BOARD](#) [MIKROBOARD FOR ARM 64-PIN](#) [MIKROLAB FOR AVR](#) [MIKROLAB FOR AVR L](#) [MIKROLAB FOR](#)
[DSPIC](#) [MIKROLAB FOR DSPIC XL](#) [MIKROLAB FOR PIC32](#) [MIKROLAB FOR TIVA](#) [EASYAVR V7](#) [EASYMX PRO FOR TIVA C](#)
[SERIES](#) [EASYMX PRO V7 FOR STM32](#) [EASYPIC FUSION V7](#)