

user's guide to

Expand development system capabilities by adding 12bit Digital to Analog Converter

12bit-DAC

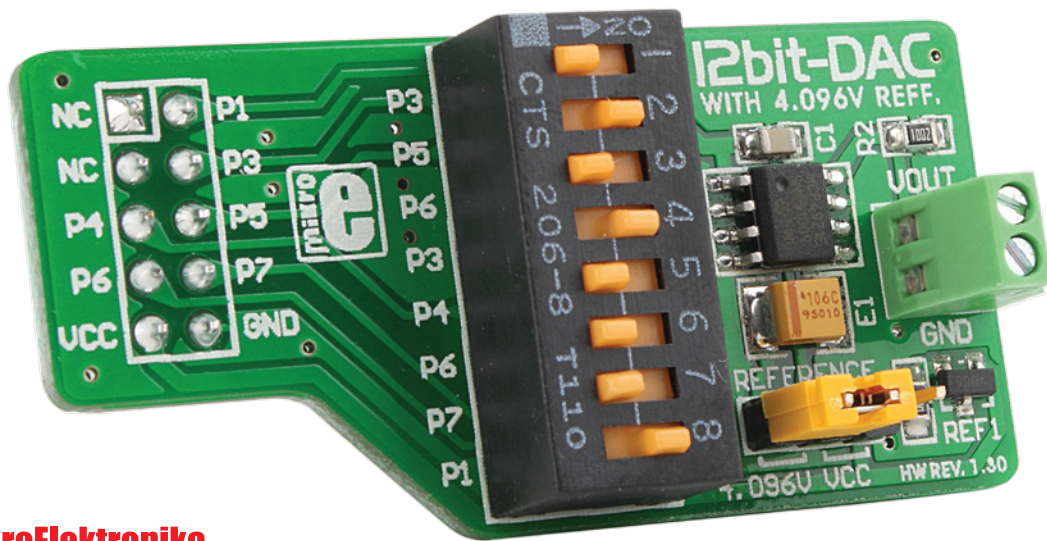

TO OUR VALUED CUSTOMERS

I want to express my thanks to you for being interested in our products and for having confidence in Mikroelektronika.

The primary aim of our company is to design and produce high quality electronic products and to constantly improve the performance thereof in order to better suit your needs.



Nebojsa Matic
General Manager

Table of Contents

Introduction to 12bit-DAC	4
Key features	4
System Specification	5
1. Connecting with development system	6
2. DIP switch settings	7
3. Connecting 12bit-DAC with analog device	8
4. Jumper settings for reference voltage	9
5. Schematic	10
6. Dimensions	11

Introduction to 12bit-DAC

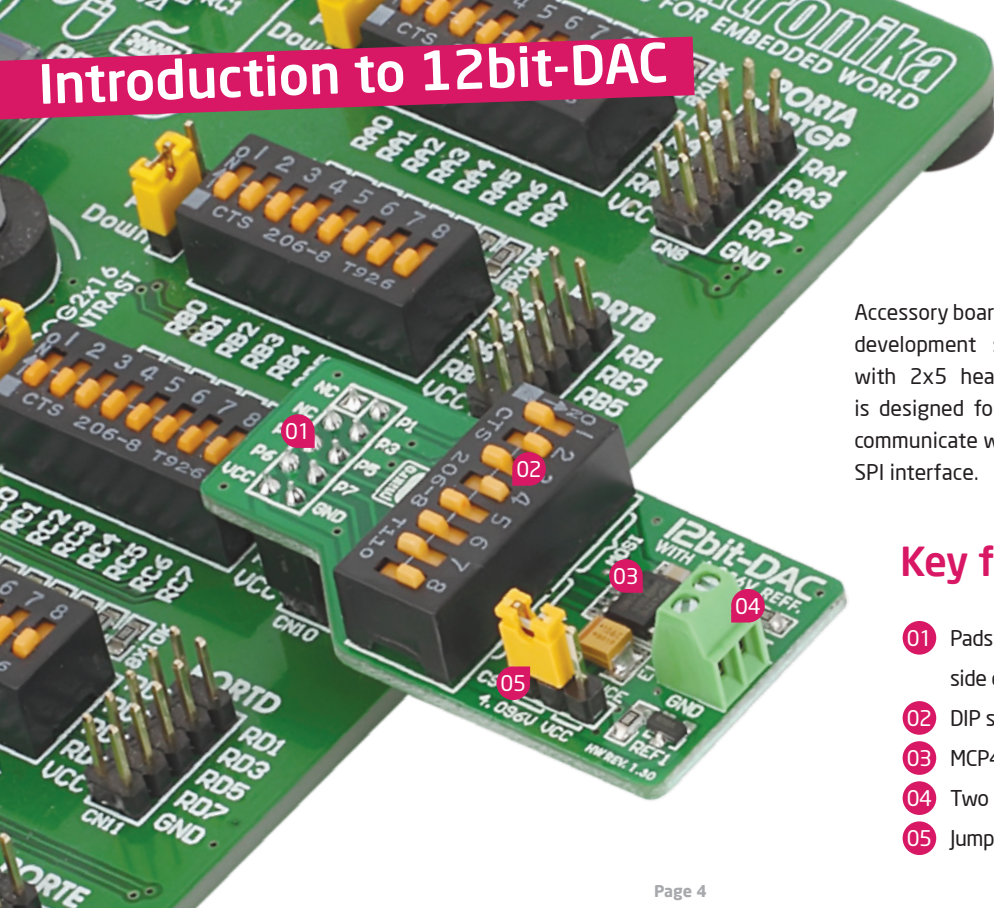

Accessory board is designed for usage with various development systems and other MCU device with 2x5 header. 12bit -DAC additional board is designed for Digital to Analog Conversion. To communicate with MCU accessory board use serial SPI interface.

Key features

- 01 Pads with female 2x5 header on back side of the board
- 02 DIP switch for pin selection
- 03 MCP4921 chip
- 04 Two pole screw terminal CN2
- 05 Jumpers for selecting reference voltage

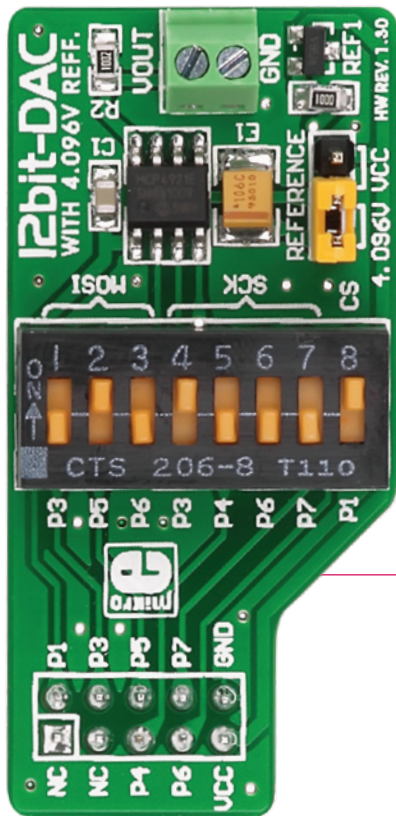

System Specification



power supply

3.3V to 5V DC depends on development system in use



power consumption

max 50mA (current at supply pins)

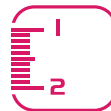

board dimensions

49.59 x 23.88mm (1.95 x 0.94")



weight

~9g (0.02 lbs)

1. Connecting with development system

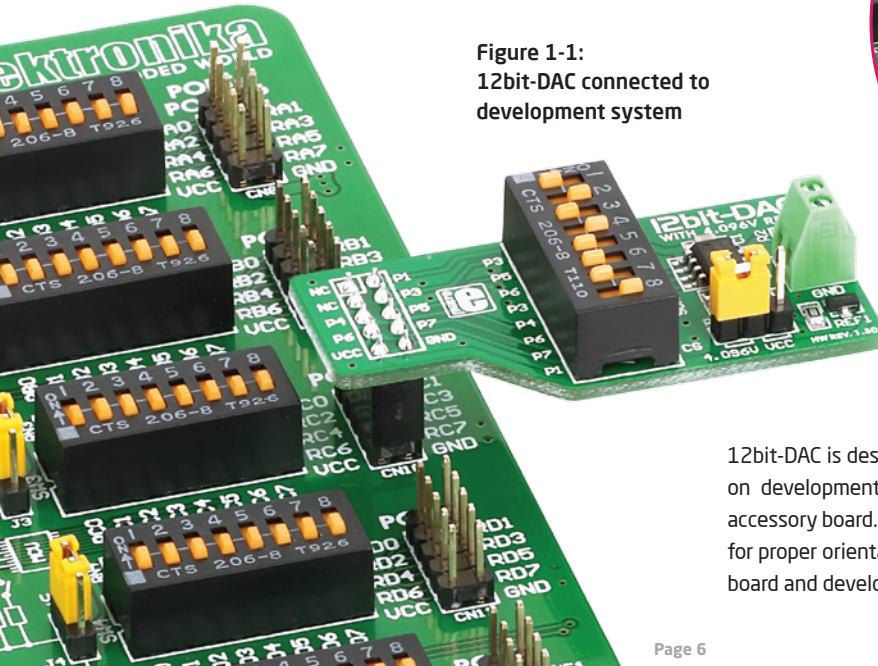

Figure 1-1:
12bit-DAC connected to
development system

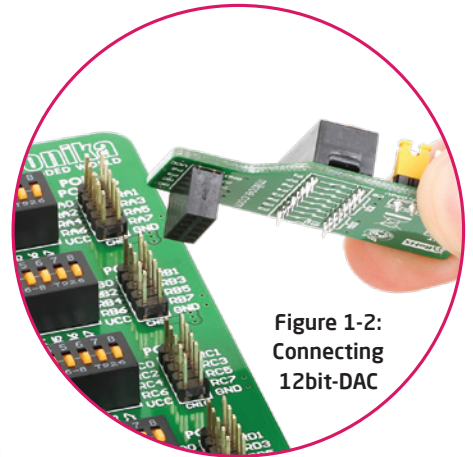

Figure 1-2:
Connecting
12bit-DAC

12bit-DAC is designed for connection with 2x5 male headers on development system port's via 2x5 female header on accessory board. Every pin on 2x5 female header is marked so for proper orientation just compare marks between accessory board and development system.

2. DIP switch settings

In order to connect 12bit-DAC to different development system it is necessary to make settings on DIP switch SW1. Every pin on DIP switch SW1 is connected to different pin of 2x5 female header. In table 1 is given list which switch on DIP switch SW1 should be turned ON for different development system.

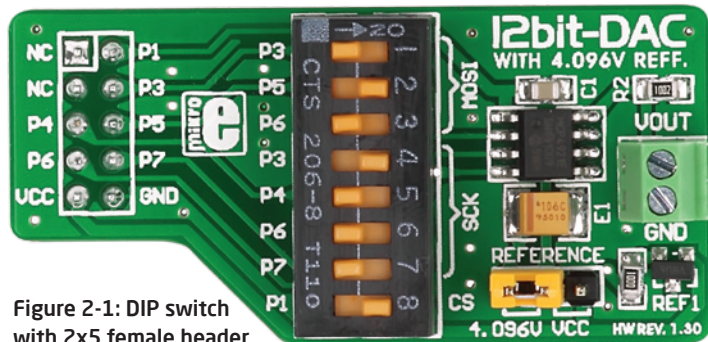

Figure 2-1: DIP switch with 2x5 female header

Table 1

Development system:	Turn ON switch number:	Pin on female 2x5 header:	Pin function:
EasyPIC, BIGPIC, LV18F, Easy LV18F, Easy 24-33	4	P3	SCK
Easy dsPIC	1	P3	MOSI
BIGdsPIC, dsPIC PRO, EasyARM	5	P4	SCK
EasyPIC, BIGPIC, LV18F, Easy LV18F, Easy 24-33, EasyAVR6, Easy 8051	2	P5	MOSI
BIGdsPIC, dsPIC PRO, EasyARM	3	P6	MOSI
EasydsPIC	3	P6	SCK
EasyAVR, Easy 8051	7	P7	SCK
All development systems	8	P1	CS

3. Connecting 12bit-DAC with analog device

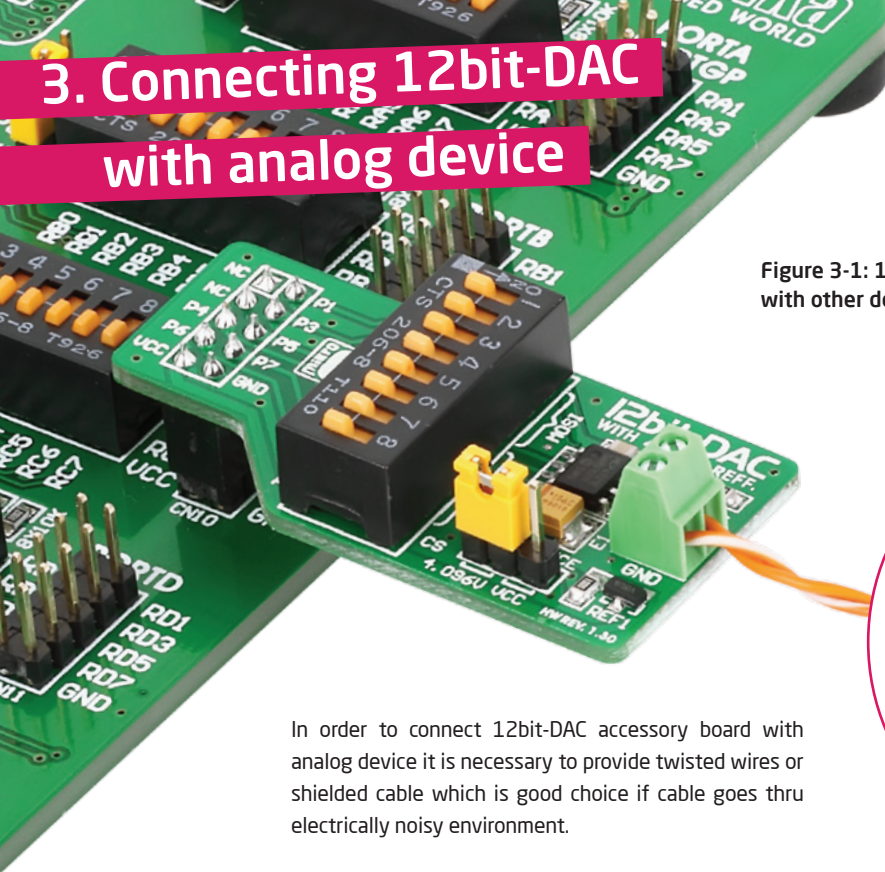

Figure 3-1: 12bit-DAC connected with other device via wire

In order to connect 12bit-DAC accessory board with analog device it is necessary to provide twisted wires or shielded cable which is good choice if cable goes thru electrically noisy environment.

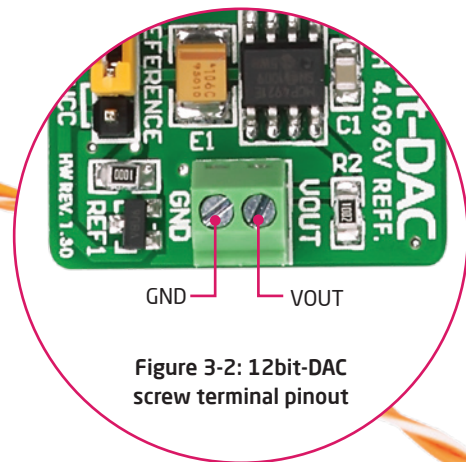

Figure 3-2: 12bit-DAC screw terminal pinout

4. Jumper settings for reference voltage

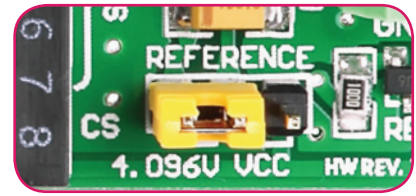

Figure 4-1: Ref. voltage is 4.096V



Figure 4-2: Ref. voltage is VCC

In order to set reference voltage (V_{ref}) it is necessary to place jumper J1 in adequate position. To use reference voltage of 4.096V place jumper J1 to 4.096 position, Figure 4-1. For VCC reference voltage (3.3V or 5V depends on development system in use) place jumper J1 in VCC position, Figure 4-2.

5. Schematic

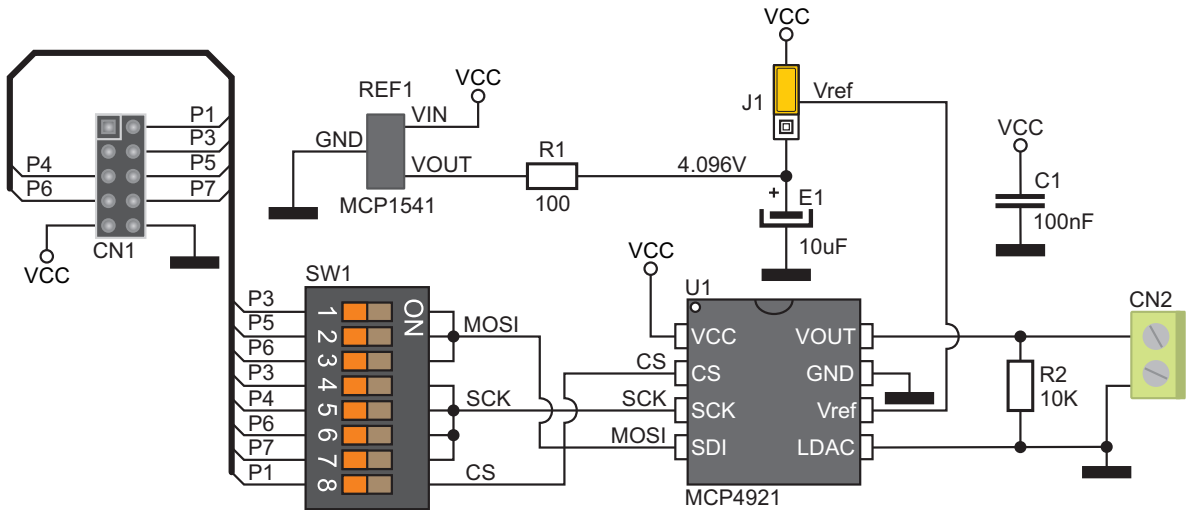

Figure 5-1: Connection schematic

6. Dimensions

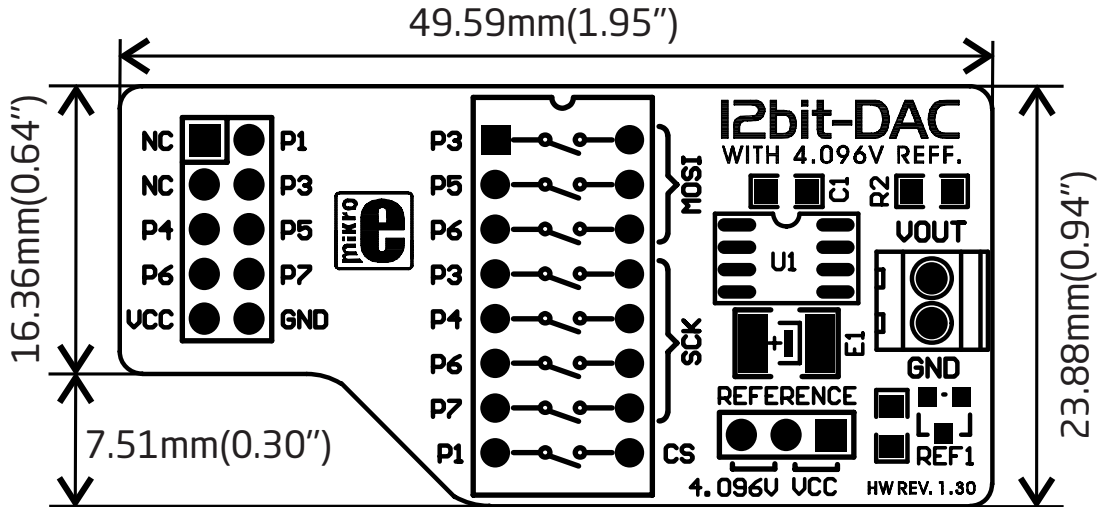

Figure 6-1: Dimensions

Notes:

Notes:

Notes:

DISCLAIMER

All the products owned by MikroElektronika are protected by copyright law and international copyright treaty. Therefore, this manual is to be treated as any other copyright material. No part of this manual, including product and software described herein, may be reproduced, stored in a retrieval system, translated or transmitted in any form or by any means, without the prior written permission of MikroElektronika. The manual PDF edition can be printed for private or local use, but not for distribution. Any modification of this manual is prohibited.

MikroElektronika provides this manual 'as is' without warranty of any kind, either expressed or implied, including, but not limited to, the implied warranties or conditions of merchantability or fitness for a particular purpose.

MikroElektronika shall assume no responsibility or liability for any errors, omissions and inaccuracies that may appear in this manual. In no event shall MikroElektronika, its directors, officers, employees or distributors be liable for any indirect, specific, incidental or consequential damages (including damages for loss of business profits and business information, business interruption or any other pecuniary loss) arising out of the use of this manual or product, even if MikroElektronika has been advised of the possibility of such damages. MikroElektronika reserves the right to change information contained in this manual at any time without prior notice, if necessary.

HIGH RISK ACTIVITIES

The products of MikroElektronika are not fault - tolerant nor designed, manufactured or intended for use or resale as on - line control equipment in hazardous environments requiring fail - safe performance, such as in the operation of nuclear facilities, aircraft navigation or communication systems, air traffic control, direct life support machines or weapons systems in which the failure of Software could lead directly to death, personal injury or severe physical or environmental damage ('High Risk Activities'). MikroElektronika and its suppliers specifically disclaim any expressed or implied warranty of fitness for High Risk Activities.

TRADEMARKS

The Mikroelektronika name and logo, the Mikroelektronika logo, mikroC, mikroC PRO, mikroBasic, mikroBasic PRO, mikroPascal, mikroPascal PRO, AVRflash, PICflash, dsPICprog, 18FJprog, PSOCprog, AVRprog, 8051prog, ARMflash, EasyPIC5, EasyPIC6, BigPIC5, BigPIC6, dsPIC PRO4, Easy8051B, EasyARM, EasyAVR5, EasyAVR6, BigAVR2, EasydsPIC4A, EasyPSoC4, EasyAVR Stamp LV18FJ, LV24-33A, LV32MX, PIC32MX4 MultiMedia Board, PICPLC16, PICPLC8 PICPLC4, SmartGSM/GPRS, UNI-DS are trademarks of Mikroelektronika. All other trademarks mentioned herein are property of their respective companies.

All other product and corporate names appearing in this manual may or may not be registered trademarks or copyrights of their respective companies, and are only used for identification or explanation and to the owners' benefit, with no intent to infringe.

12bit-DAC

v1.30

If you want to learn more about our products, please visit our website at www.mikroe.com

If you are experiencing some problems with any of our products or just need additional information, please place your ticket at www.mikroe.com/en/support

If you have any questions, comments or business proposals,
do not hesitate to contact us at office@mikroe.com

X-ON Electronics

Largest Supplier of Electrical and Electronic Components

Click to view similar products for [Data Conversion IC Development Tools](#) category:

Click to view products by [MikroElektronika](#) manufacturer:

Other Similar products are found below :

[EVAL-AD7265EDZ](#) [EVAL-AD7719EBZ](#) [EVAL-AD7767-1EDZ](#) [EVAL-AD7995EBZ](#) [AD9211-200EBZ](#) [AD9251-20EBZ](#) [AD9251-65EBZ](#)
[AD9613-170EBZ](#) [AD9629-20EBZ](#) [AD9716-DPG2-EBZ](#) [AD9737A-EBZ](#) [AD9993-EBZ](#) [DAC8555EVM](#) [EVAL-AD5061EBZ](#) [EVAL-](#)
[AD5062EBZ](#) [EVAL-AD5443-DBRDZ](#) [EVAL-AD5570SDZ](#) [EVAL-AD7992EBZ](#) [EVAL-AD7994EBZ](#) [AD9119-MIX-EBZ](#) [AD9233-125EBZ](#)
[AD9629-80EBZ](#) [AD9650-80EBZ](#) [AD9767-EBZ](#) [DAC8531EVM](#) [LM96080EB/NOPB](#) [EVAL-AD5445SDZ](#) [EVAL-AD5660EBZ](#) [EVAL-](#)
[AD7685SDZ](#) [EVAL-AD7687SDZ](#) [EVAL-ADE7763ZEB](#) [MAX5318PMB#](#) [MAX1246EVL11-QSOP](#) [MAX117EVKIT-DIP](#) [DC2365A-C](#)
[DC2795A-B](#) [DC2795A-A](#) [DAC088S085EB/NOPB](#) [SIM8909-EVB-KIT](#) [82635ASRCDVKHV 961443](#) [DC1466B-B](#) [EVAL-AD5413SDZ](#)
[ADC12D1600RB/NOPB](#) [1083](#) [RFPDK FOR CMT2X5X](#) [TS7003DB](#) [TSC2014EVM-PDK](#) [MOD-USB3G](#) [KDC5514EVALZ](#)
[DAC5675AEVM](#)