

A new idea is just a click away

Adding a new functionality to your design was never so easy. Sensors? Displays? Wireless transceivers? Motor control? Connection ports? Encoders? Or how about speech recognition, thunder detection, fingerprint scanning?

Pick from hundreds of Click boards™ - presented here in 1:1 scale - plug one into the mikroBUS™ socket, and it's ready to work right away.

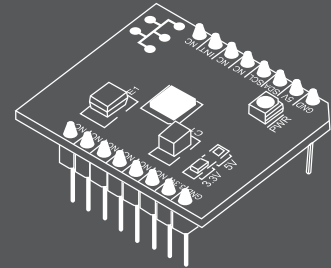
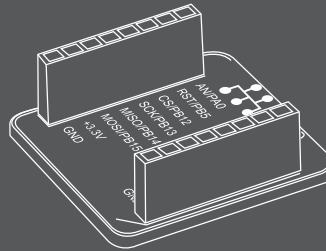

MIKROE

Click boards™

Ever-growing range of standardized add-on boards

WiFi, LoRa, BLE, GSM, GPS, OLED, speech recognition, environmental sensors, movement sensors, biosensors, LEDs, ADCs, relays - you name it, we got it. There are hundreds of Click boards available.



3G Click (USA)

5V | 3.3V | SPI | I2C

UART | GPIO | PWM | AN

UG95 3G UMTS/HSPA module. With SIM card slot, Audio/Mic jack, micro USB port.

MSRP - \$89⁰⁰
MIKROE-2296



3G Click (EU/AUS)

5Va | 3.3V | SPI | I2C

UART | GPIO | PWM | AN

UG95 3G UMTS/HSPA module. With SIM card slot, Audio/Mic jack, micro USB port.

MSRP - \$89⁰⁰
MIKROE-2226



3G SARA Click

5V | 3.3V | SPI | I2C

UART | GPIO | PWM | AN

With UMTS/HSPA cellular modem – the u-blox U201, from the SARA series.

MSRP - \$99⁰⁰
MIKROE-2244



4G LTE-E Click

5V | 3.3V | SPI | I2C

UART | GPIO | PWM | AN

It features the LARA-R211 multi-mode cellular module from u-blox.

MSRP - \$115⁰⁰
MIKROE-2527



4G LTE-NA Click

5V | 3.3V | SPI | I2C

UART | GPIO | PWM | AN

It features the LARA-R204 multi-mode cellular module from u-blox.

MSRP - \$115⁰⁰
MIKROE-2535



6LoWPAN C Click

5V | 3.3V | SPI | I2C

UART | GPIO | PWM | AN

TI's CC2520, 2.4GHz ZigBee®/IEEE 802.15.4 RF transceiver.

MSRP – \$26⁰⁰
MIKROE-2219



6LoWPAN T Click

5V | 3.3V | SPI | I2C

UART | GPIO | PWM | AN

TI's CC2520, 2.4GHz ZigBee®/IEEE 802.15.4 RF transceiver.

MSRP – \$26⁰⁰
MIKROE-2218

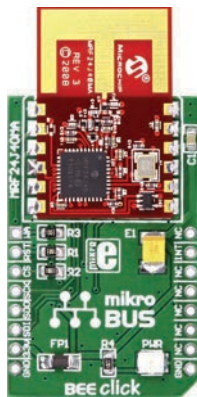

BEE Click

5V | 3.3V | SPI | I2C

UART | GPIO | PWM | AN

Microchip's MRF24J-40MA 2.4 GHz IEEE 802.15.4 radio transceiver module.

MSRP – \$29⁰⁰
MIKROE-987



BLE 2 Click

5V | 3.3V | SPI | I2C

UART | GPIO | PWM | AN

With RN4020 Bluetooth 4.1 module. Can be set up both as a client or a server.

MSRP – \$30⁰⁰
MIKROE-1715



BLE 3 Click

5V | 3.3V | SPI | I2C

UART | GPIO | PWM | AN

It features NINA-B1 Bluetooth 4.2 module from u-blox.

MSRP – \$39⁰⁰
MIKROE-2471



BLE P Click

5V | 3.3V | SPI | I2C
UART | GPIO | PWM | AN

With nRF8001 Bluetooth 4.0 peripheral device. Open source Android app available.

MSRP – \$25⁰⁰
MIKROE-1597



Bluetooth Click

5V | 3.3V | SPI | I2C
UART | GPIO | PWM | AN

It features the RN-41 low power, class 1 Bluetooth radio module.

MSRP – \$39⁰⁰
MIKROE-958



BT Audio Click

5V | 3.3V | SPI | I2C
UART | GPIO | PWM | AN

With RN52 Bluetooth audio module and on-board 3.5mm jacks for a mic and a speaker.

MSRP – \$49⁰⁰
MIKROE-2399

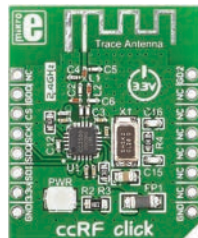

ccRF Click

5V | 3.3V | SPI | I2C
UART | GPIO | PWM | AN

With CC2500 low-power 2.4 GHz RF transceiver and PCB trace antenna.

MSRP – \$22⁰⁰
MIKROE-1435

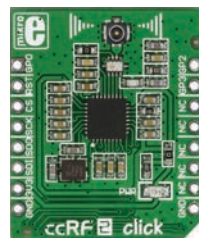

ccRF 2 Click

5V | 3.3V | SPI | I2C
UART | GPIO | PWM | AN

With CC1120, high performance radio transceiver for ISRM and SRD bands.

MSRP – \$36⁰⁰
MIKROE-1716



ccRF 3 Click

5V | 3.3V | SPI | I2C

UART | GPIO | PWM | AN

Carries the CC1120 high-performance RF transceiver for narrow-band systems from TI.

MSRP – \$36⁰⁰
MIKROE-2389



EnOcean Click

5V | 3.3V | SPI | I2C

UART | GPIO | PWM | AN

With TCM 310 transceiver - bidirectional gateway for EnOcean's 868 MHz radio systems.

MSRP – \$39⁰⁰
MIKROE-1908



EnOcean 2 Click

5V | 3.3V | SPI | I2C

UART | GPIO | PWM | AN

With TCM 515Z transceiver, based on the 2.4 GHz IEEE 802.15.4 radio standard.

MSRP – \$39⁰⁰
MIKROE-2521

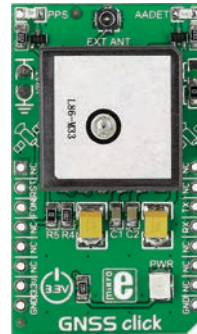

GNSS Click

5V | 3.3V | SPI | I2C

UART | GPIO | PWM | AN

Quectel's L86 GNSS module with a patch antenna and an external antenna connector.

MSRP – \$46⁰⁰
MIKROE-1850



GNSS 2 Click

5V | 3.3V | SPI | I2C

UART | GPIO | PWM | AN

Quectel's L76 module and SMA antenna connector. GPS + GLONASS.

MSRP – \$39⁰⁰
MIKROE-1887



GNSS 3 Click

5V | 3.3V | SPI | I2C
UART | GPIO | PWM | AN

Carries SIM33ELAGNSS module with an integrated antenna and an external antenna connector.

MSRP – \$339⁰⁰
MIKROE-1895



GNSS 4 Click

5V | 3.3V | SPI | I2C
UART | GPIO | PWM | AN

It features SAM-M8Q patch antenna

MSRP – \$44⁰⁰
MIKROE-2045



GNSS 5 Click

5V | 3.3V | SPI | I2C
UART | GPIO | PWM | AN

It features NEO-M8N GNSS receiver module from u-blox.

MSRP – \$41⁰⁰
MIKROE-2670



GPS Click

5V | 3.3V | SPI | I2C
UART | GPIO | PWM | AN

It carries LEA-6S high-performance position engine from u-blox.

MSRP – \$49⁰⁰
MIKROE-1032



GPS 3 Click

5V | 3.3V | SPI | I2C
UART | GPIO | PWM | AN

With Quectel's L80, high-sensitivity GPS module with a patch antenna.

MSRP – \$44⁰⁰
MIKROE-1714



GSM-GPS Click

5V 3.3V SPI I2C

UART GPIO PWM AN

With SIM808, GSM/GPRS and GPS module. Two antenna connectors, SIM card slot, a micro USB connector.

MSRP – \$85⁰⁰
MIKROE-2382



GSM Click

5V 3.3V SPI I2C

UART GPIO PWM AN

With quad-band GL865-QUAD GSM/ GPRS module, onboard antenna connector and SIM card socket.

MSRP – \$49⁰⁰
MIKROE-1298



GSM 2 Click

5V 3.3V SPI I2C

UART GPIO PWM AN

With Quectel's M95 FA quad-band GSM/GPRS module. 85.6 kbps GPRS data transfer.

MSRP – \$44⁰⁰
MIKROE-1375



GSM 3 Click

5V 3.3V SPI I2C

UART GPIO PWM AN

With SIM800H quad-band GSM/GPRS module. 85.6 kbps GPRS data transfer.

MSRP – \$57⁰⁰
MIKROE-1720



GSM/GNSS Click

5V 3.3V SPI I2C

UART GPIO PWM AN

Quectel's MC60 quad-band GSM/GPRS/GNSS module. GPS/GNSS location tracking with GSM.

MSRP – \$79⁰⁰
MIKROE-2439



GSM/GNSS 2 Click

5V | 3.3V | SPI | I2C
UART | GPIO | PWM | AN

With SIM868 quad-band GSM/GPRS module. GPS/GNSS location tracking with GSM.

MSRP – \$69⁰⁰
MIKROE-2440

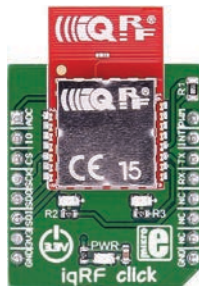

iQRF Click

5V | 3.3V | SPI | I2C
UART | GPIO | PWM | AN

With DCTR-76DA RF transceiver, operating in the 868/916 MHz frequency.

MSRP – \$43⁰⁰
MIKROE-2586



iQRF 2 Click

5V | 3.3V | SPI | I2C
UART | GPIO | PWM | AN

With DCTR-72DAT RF transceiver, operating in the 868/916 MHz frequency.

MSRP – \$49⁰⁰
MIKROE-2587

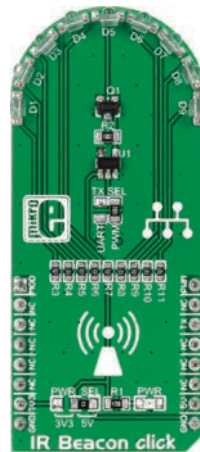

IR Beacon Click

5V | 3.3V | SPI | I2C
UART | GPIO | PWM | AN

Functions as a beacon device with nine VSMB-2948SL high speed infrared emitting diodes.

MSRP – \$21⁰⁰
MIKROE-1939

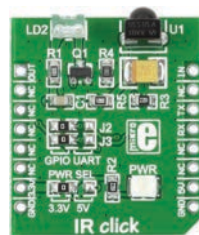

IR Click

5V | 3.3V | SPI | I2C
UART | GPIO | PWM | AN

Features TSOP38338 IR 38 kHz receiver module as well as QEE113 IR emitting diode.

MSRP – \$9⁵⁰
MIKROE-1377

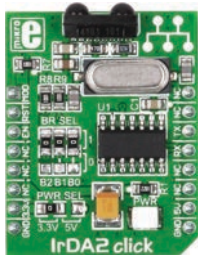

IrDA2 Click

5V 3.3V SPI I2C
UART GPIO PWM AN

With TFDU4101 infrared transceiver module and MCP2120 infrared encoder/decoder.

MSRP - \$25⁰⁰
MIKROE-1195



LoRa RF Click

5V 3.3V SPI I2C
UART GPIO PWM AN

With RN2483 LoRa Sub-GHz, 433/868 MHz European R&TTE Directive Assessed Radio Modem.

MSRP - \$54⁰⁰
MIKROE-1997



LoRa RF 2 Click

5V 3.3V SPI I2C
UART GPIO PWM AN

With RN2903 915 MHz Radio Modem compliant with regulations for use in the USA, CA, AU, NZ.

MSRP - \$54⁰⁰
MIKROE-2225



LoRa 3 Click

5V 3.3V SPI I2C
UART GPIO PWM AN

A LoRa technology-based SRD transceiver, operates at a sub-gigahertz frequency of 868MHz.

MSRP - \$52⁰⁰
MIKROE-2933



LoRa 4 Click

5V 3.3V SPI I2C
UART GPIO PWM AN

A LoRa RF technology based SRD transceiver, operates at a sub-gigahertz frequency of 868MHz.

MSRP - \$52⁰⁰
MIKROE-2934



NFC Tag Click

5V | 3.3V | SPI | I2C
UART | GPIO | PWM | AN

With M24SR64 NFC/RFID tag IC with a dual interface and 8KB of high-reliability EEPROM built-in.

MSRP – \$12⁰⁰
MIKROE-1726



NFC Tag 2 Click

5V | 3.3V | SPI | I2C
UART | GPIO | PWM | AN

Carries NT3H1101 NTAG I2C energy harvesting NFC Forum Type 2 Tag from NXP.

MSRP – \$12⁰⁰
MIKROE-2462



nRF C Click

5V | 3.3V | SPI | I2C
UART | GPIO | PWM | AN

With nRF24L01P 2.4 GHz transceiver. Air data rates of 250 Kbps, 1 Mbps and 2 Mbps.

MSRP – \$19⁰⁰
MIKROE-1304



nRF S Click

5V | 3.3V | SPI | I2C
UART | GPIO | PWM | AN

With nRF24L01P 2.4 GHz transceiver. 250 Kbps, 1 Mbps and 2 Mbps air data rates.

MSRP – \$19⁰⁰
MIKROE-1836



nRF T Click

5V | 3.3V | SPI | I2C
UART | GPIO | PWM | AN

With nRF24L01P 2.4 GHz transceiver module. Air data rates of 250 Kbps, 1 Mbps and 2 Mbps.

MSRP – \$16⁰⁰
MIKROE-1305

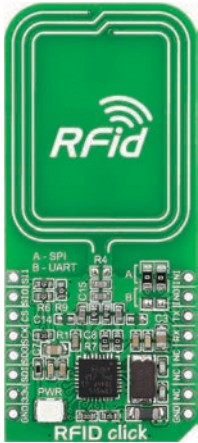

RFid Click

5V | 3.3V | SPI | I2C
 UART | GPIO | PWM | AN

With CR95HF 13.56 MHz contactless Rfid transceiver, and trace antenna.

MSRP - \$29⁰⁰
 MIKROE-1434

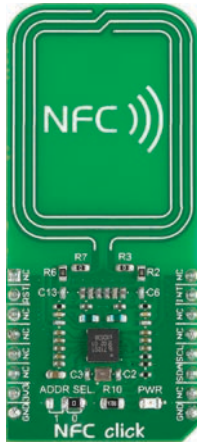

NFC Click

5V | 3.3V | SPI | I2C
 UART | GPIO | PWM | AN

With near field communications controller PN7120 IC from NXP.

MSRP - \$34⁰⁰
 MIKROE-2395

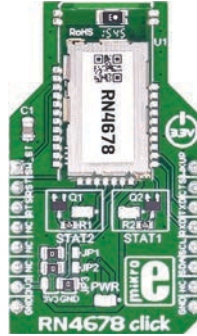

RN4678 Click

5V | 3.3V | SPI | I2C
 UART | GPIO | PWM | AN

It carries RN4678 Bluetooth® 4.2 dual mode module from Microchip.

MSRP - \$29⁰⁰
 MIKROE-2545



RN4870 Click

5V | 3.3V | SPI | I2C
 UART | GPIO | PWM | AN

It carries RN4870 Bluetooth® 4.2 low energy module from Microchip.

MSRP - \$33⁰⁰
 MIKROE-2543

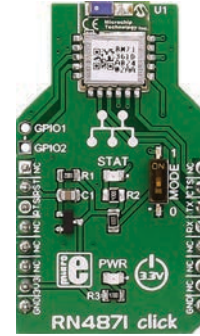

RN4871 Click

5V | 3.3V | SPI | I2C
 UART | GPIO | PWM | AN

It carries RN4871 Bluetooth® 4.2 low energy module from Microchip.

MSRP - \$33⁰⁰
 MIKROE-2544



tRF Click

5V | 3.3V | SPI | I2C
UART | GPIO | PWM | AN

With Telit's LE70-868 — a 868 MHz transceiver module with embedded stack.

MSRP – \$59⁰⁰
MIKROE-1535

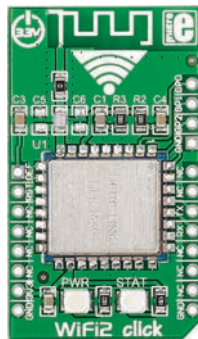

WiFi 2 Click

5V | 3.3V | SPI | I2C
UART | GPIO | PWM | AN

With HLM-K30 module. Can be set up with either a static or dynamic IP address.

MSRP – \$29⁰⁰
MIKROE-1768



WiFi 3 Click

5V | 3.3V | SPI | I2C
UART | GPIO | PWM | AN

With ESP8266 module. TCP/IP stack. Supports Wi-Fi Direct [p2p]. 6 GPIO pins.

MSRP – \$27⁰⁰
MIKROE-1769



WiFi 4 Click

5V | 3.3V | SPI | I2C
UART | GPIO | PWM | AN

With SPWF01SA standalone WiFi module. Built-in 2.45 GHz ISM band antenna.

MSRP – \$49⁰⁰
MIKROE-1913



WiFi 5 Click

5V | 3.3V | SPI | I2C
UART | GPIO | PWM | AN

With Gainspan's GS1500M 802.11b/g/n Low Power Wi-Fi module with a PCB trace antenna.

MSRP – \$29⁰⁰
MIKROE-2274

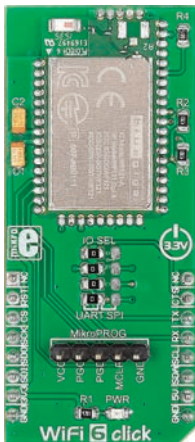

WiFi 6 Click

5V | 3.3V | SPI | I2C

UART | GPIO | PWM | AN

With WF121-A self-contained WiFi module. 2.4GHz band IEEE 802.11 b/g/n radio.

MSRP – \$69⁰⁰
MIKROE-2043

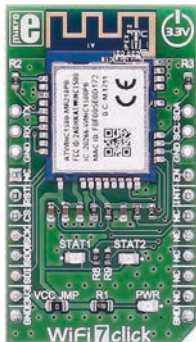

WiFi 7 Click

5V | 3.3V | SPI | I2C

UART | GPIO | PWM | AN

With ATWINC1510-MR210PB IEEE 802.11 b/g/n module, 20MHz solution.

MSRP – \$29⁰⁰
MIKROE-2046



WiFi ESP Click

5V | 3.3V | SPI | I2C

UART | GPIO | PWM | AN

With ESP-WROOM-02 module that integrates ESP8266EX. In AP WiFi and WiFi client mode.

MSRP – \$15⁰⁰
MIKROE-2542



WiFi PLUS Click

5V | 3.3V | SPI | I2C

UART | GPIO | PWM | AN

With MRF24WB-OMA 2.4GHz, IEEE std. 802.11 module and MCW1001 controller.

MSRP – \$45⁰⁰
MIKROE-1135



WiFly Click

5V | 3.3V | SPI | I2C

UART | GPIO | PWM | AN

With RN-131 embedded wireless LAN module. Qualified 2.4-GHz IEEE 802.11 b/g transceiver.

MSRP – \$69⁰⁰
MIKROE-1937



AnyNet 2G Click

5V | 3.3V | SPI | I2C
UART | GPIO | PWM | AN

WiFi module with integrated IPv4 TCP/IP stack and built-in network protocols.

MSRP – \$69⁰⁰
MIKROE-2747



AnyNet 3G-EA Click

5V | 3.3V | SPI | I2C
UART | GPIO | PWM | AN

A secure connection with the AWS over the air (OTA), by utilizing the Quectel UG95 3G module.

MSRP – \$89⁰⁰
MIKROE-2975



CC3100 Click

5V | 3.3V | SPI | I2C
UART | GPIO | PWM | AN

Carries low power, high security Wi-Fi CC3100 module. Support for 802.11n.

MSRP – \$49⁰⁰
MIKROE-2336



OOK RX Click

5V | 3.3V | SPI | I2C
UART | GPIO | PWM | AN

A wireless receiver that operates at the frequency of 433MHz [sub-GHz].

MSRP – \$19⁰⁰
MIKROE-2902



OOK TX Click

5V | 3.3V | SPI | I2C
UART | GPIO | PWM | AN

A wireless transmitter that operates at the frequency of 433MHz [sub-GHz].

MSRP – \$19⁰⁰
MIKROE-2903



WiFi NINA Click

5V | 3.3V | SPI | I2C
 UART | GPIO | PWM | AN

A standalone WiFi module, with the state-of-the-art NINA-W132 module from u-blox.

MSRP – \$45⁰⁰
 MIKROE-2921



MiWi Click

5V | 3.3V | SPI | I2C
 UART | GPIO | PWM | AN

A subgigahertz radio transceiver which offers a reliable FSK or OOK communication solution.

MSRP – \$17⁰⁰
 MIKROE-2924



MiWi 2 Click

5V | 3.3V | SPI | I2C
 UART | GPIO | PWM | AN

A subgigahertz radio transceiver which offers a reliable FSK or OOK communication solution.

MSRP – \$17⁰⁰
 MIKROE-2925



M-BUS RF Click

5V | 3.3V | SPI | I2C
 UART | GPIO | PWM | AN

With ME70-169 RF wireless module. Unlicensed ISM frequency band 169.400-169.475 MHz.

MSRP – \$54⁰⁰
 MIKROE-2048

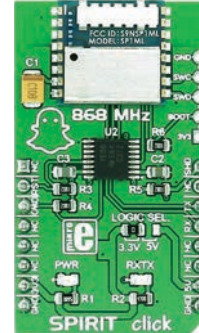

SPIRIT Click

5V | 3.3V | SPI | I2C
 UART | GPIO | PWM | AN

With SP1ML 868MHz ultra low-power RF module. Memory: 16 kB RAM and 128 kB Flash.

MSRP – \$39⁰⁰
 MIKROE-2568



XBEE Click

5V | 3.3V | SPI | I2C
UART | GPIO | PWM | AN

Xbee® and Zig-
bee-compliant XB-
24CZ7PIS-004 module
with a PCB antenna.

MSRP – \$59⁰⁰
MIKROE-1599

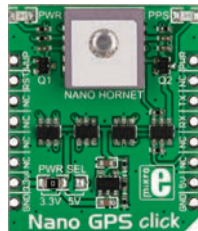

NANO GPS Click

5V | 3.3V | SPI | I2C
UART | GPIO | PWM | AN

With Nano Hornet,
world's smallest GPS
module with an inte-
grated antenna.

MSRP – \$45⁰⁰
MIKROE-1912



GPS 4 Click

5V | 3.3V | SPI | I2C
UART | GPIO | PWM | AN

GPS 4 click carries
the L70 compact GPS
module from Quectel,
with external antenna.

MSRP – \$34⁰⁰
MIKROE-2704



GSM 4 Click

5V | 3.3V | SPI | I2C
UART | GPIO | PWM | AN

Compact quad-band
GSM solution, featur-
ing the quad-band
SARA-G350 module.

MSRP – \$74⁰⁰
MIKROE-2388



LTE IoT Click

5V | 3.3V | SPI | I2C
UART | GPIO | PWM | AN

Compact quad-band
GSM solution, featur-
ing the quad-band
SARA-G350 module.

MSRP – \$79⁰⁰
MIKROE-3072



LTE IoT 2 Click

5V | 3.3V | SPI | I2C
 UART | GPIO | PWM | AN

Allows connection to the LTE networks, featuring Quectel BG96 LTE module.

MSRP – \$69⁰⁰
 MIKROE-3144



SigFox Click

5V | 3.3V | SPI | I2C
 UART | GPIO | PWM | AN

Carries the SN10-11, a fully integrated Sigfox™ certified module by InnoComm.

MSRP – \$25⁰⁰
 MIKROE-2534



SigFox 2 Click

5V | 3.3V | SPI | I2C
 UART | GPIO | PWM | AN

Carries the SN10-12, a fully integrated Sigfox™ certified module by InnoComm.

MSRP – \$25⁰⁰
 MIKROE-3039



SigFox 3 Click

5V | 3.3V | SPI | I2C
 UART | GPIO | PWM | AN

Carries the SN10-13, a fully integrated Sigfox™ certified module by InnoComm.

MSRP – \$25⁰⁰
 MIKROE-3163



NB IoT Click

5V | 3.3V | SPI | I2C
 UART | GPIO | PWM | AN

Allows LTE Cat NB1 connectivity by utilizing Quectel BC95-G

MSRP – \$52⁰⁰
 MIKROE-3294

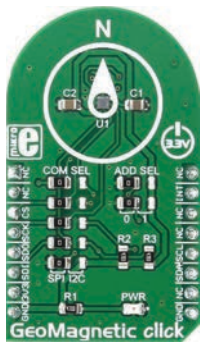

GeoMagnetic Click

5V | 3.3V | SPI | I2C
 UART | GPIO | PWM | AN

Measures the geomagnetic field in three perpendicular axes. The onboard sensor uses FlipCore from Bosch.

MSRP – \$15⁰⁰
 MIKROE-2935

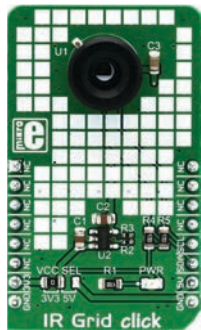

IR Grid Click

5V | 3.3V | SPI | I2C
 UART | GPIO | PWM | AN

Equipped with the MLX90621BAD, a 16x4 IR array sensor, from Melexis.

MSRP – \$69⁰⁰
 MIKROE-2622



Moisture Click

5V | 3.3V | SPI | I2C
 UART | GPIO | PWM | AN

FDC2112 IC, a very precise 12bit capacitance to digital converter, from Texas Instruments.

MSRP – \$19⁰⁰
 MIKROE-3084

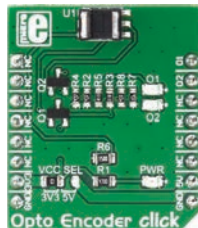

Opto Encoder Click

5V | 3.3V | SPI | I2C
 UART | GPIO | PWM | AN

Uses the TCUT1600X01, a tall dome dual channel transmissive optical sensor from Vishay.

MSRP – \$9⁰⁰
 MIKROE-2549

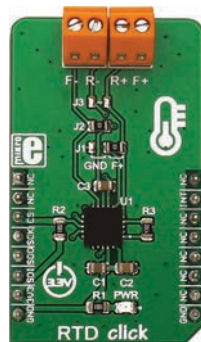

RTD Click

5V | 3.3V | SPI | I2C
 UART | GPIO | PWM | AN

It is based on MAX31865 resistance to digital converter optimized for RTDs.

MSRP – \$19⁰⁰
 MIKROE-2815

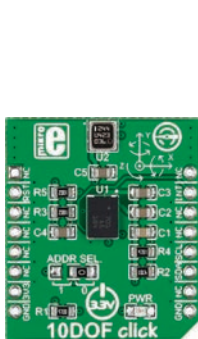

10DOF Click

5V | 3.3V | SPI | I2C

UART | GPIO | PWM | AN

With BNO055, a 9-axis absolute orientation sensor and BMP180, a digital pressure sensor.

MSRP – \$49⁰⁰
MIKROE-2073

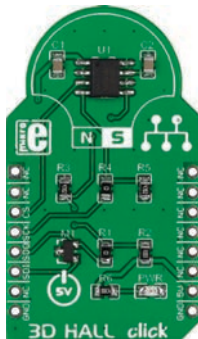

3D Hall Click

5V | 3.3V | SPI | I2C

UART | GPIO | PWM | AN

With MLX90333 3-axis Hall sensor. Detects the position of any magnet in nearby space.

MSRP – \$25⁰⁰
MIKROE-1987

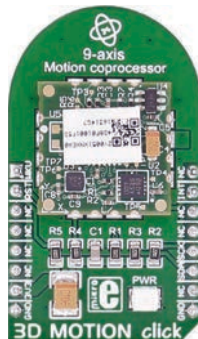

3D Motion Click

5V | 3.3V | SPI | I2C

UART | GPIO | PWM | AN

MM7150 9-axis sensor fusion motion module and SSC7150 motion coprocessor.

MSRP – \$59⁰⁰
MIKROE-1877

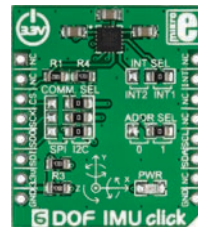

6DOF IMU Click

5V | 3.3V | SPI | I2C

UART | GPIO | PWM | AN

STM's LSM6DS33TR 6-axis IMU with 3-axis gyroscope and 3-axis accelerometer.

MSRP – \$49⁰⁰
MIKROE-1298

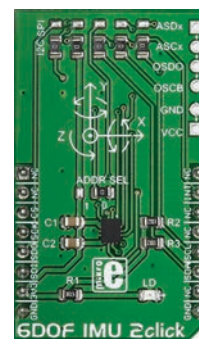

6DOF IMU 2 Click

5V | 3.3V | SPI | I2C

UART | GPIO | PWM | AN

With BMI160 low power IMU. For precise acceleration and gyroscopic measurement.

MSRP – \$24⁰⁰
MIKROE-2337

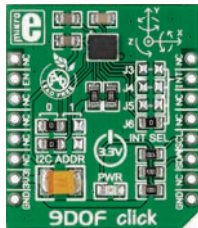

9DOF Click

5V | 3.3V | SPI | I2C
 UART | GPIO | PWM | AN

LMS9DS1 inertial measurement module - 3D accelerometer, gyroscope and magnetometer.

MSRP - \$24⁰⁰
 MIKROE-1941

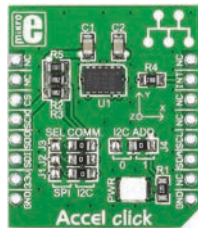

Accel Click

5V | 3.3V | SPI | I2C
 UART | GPIO | PWM | AN

With ADXL345 3-axis accelerometer. 13-bit measurement, embedded FIFO technologies.

MSRP - \$19⁰⁰
 MIKROE-1194

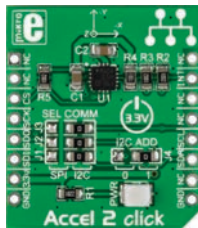

Accel 2 Click

5V | 3.3V | SPI | I2C
 UART | GPIO | PWM | AN

LIS3DSH IC 3-axis accelerometer. Embedded FIFO buffer and 2 programmable state machines.

MSRP - \$19⁰⁰
 MIKROE-1905

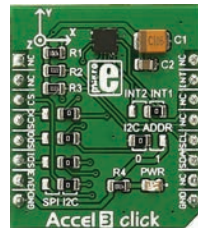

Accel 3 Click

5V | 3.3V | SPI | I2C
 UART | GPIO | PWM | AN

H3LIS331DL 3-axis linear accelerometer. Dynamically selectable scales $\pm 100g/\pm 200g/\pm 400g$.

MSRP - \$21⁰⁰
 MIKROE-2102



Air quality Click

5V | 3.3V | SPI | I2C
 UART | GPIO | PWM | AN

MQ-135 sensor for detecting gases - ammonia, nitrogen oxides, benzene, smoke, CO₂.

MSRP - \$16⁵⁰
 MIKROE-1630

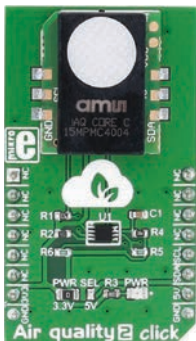

Air quality 2 Click

5V 3.3V SPI I2C

UART GPIO PWM AN

IAQ-Core that measures VOC levels and provides CO2 equivalent and TVOC equivalent predictions.

MSRP – \$79⁰⁰
MIKROE-2529

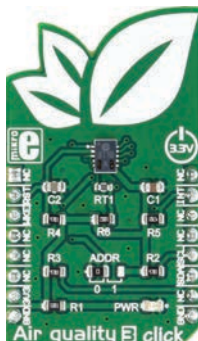

Air quality 3 Click

5V 3.3V SPI I2C

UART GPIO PWM AN

Equipped with the CCS811, an ultra-low power digital gas sensor for monitoring the indoor air quality (IAQ).

MSRP – \$29⁰⁰
MIKROE-2953



Air quality 4 Click

5V 3.3V SPI I2C

UART GPIO PWM AN

An advanced air quality sensing device that combines multiple metal-oxide sensing elements on a chip.

MSRP – \$32⁰⁰
MIKROE-2896



Air quality 5 Click

5V 3.3V SPI I2C

UART GPIO PWM AN

MiCS-6814, a compact triple MOS sensor from SGX Sensortech, with three fully independent sensors.

MSRP – \$45⁰⁰
MIKROE-3056



Hydrogen Click

5V 3.3V SPI I2C

UART GPIO PWM AN

It carries MQ-8 sensor for hydrogen [H2]. Sensor's detection range 100-10000ppm of H2.

MSRP – \$15⁰⁰
MIKROE-1629

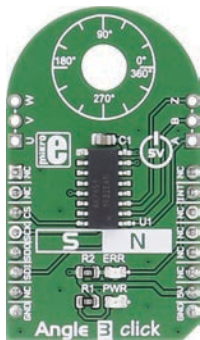

Angle 3 Click

5V 3.3V SPI I2C
UART GPIO PWM AN

With AK7451, a magnetic rotational angle sensor with 12-bit angle resolution.

MSRP – \$18⁰⁰
MIKROE-2755

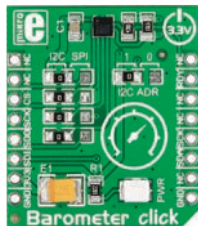

BAROMETER Click

5V 3.3V SPI I2C
UART GPIO PWM AN

LPS25HB IC, piezoresistive absolute pressure sensor. Range 260-1260 hPa.

MSRP – \$15⁰⁰
MIKROE-1817

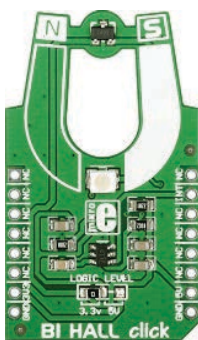

Bi Hall Click

5V 3.3V SPI I2C
UART GPIO PWM AN

US2882 bipolar Hall-effect switch and a 74LVC1T45 single bit, dual supply transceiver.

MSRP – \$12⁰⁰
MIKROE-1646

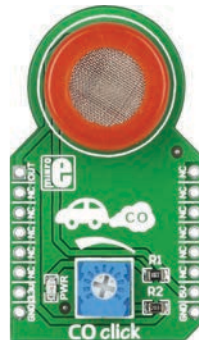

CO Click

5V 3.3V SPI I2C
UART GPIO PWM AN

MQ-7 gas sensor with high sensitivity to carbon monoxide. Detection range 20ppm-2000ppm.

MSRP – \$16⁵⁰
MIKROE-1626



Color Click

5V 3.3V SPI I2C
UART GPIO PWM AN

With TCS3471 [RGBC] color light sensor and a RGB LED diode. Resolution up to 16-bits.

MSRP – \$15⁰⁰
MIKROE-1438



Color 2 Click

5V 3.3V SPI I2C

UART GPIO PWM AN

ISL29125 RGB color light sensor. 16-bit resolution data, measuring range 5.7 mlux-10,000 lux.

MSRP – \$16⁰⁰
MIKROE-1988

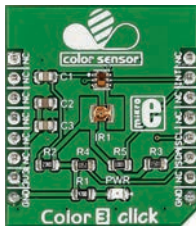

Color 3 Click

5V 3.3V SPI I2C

UART GPIO PWM AN

With TCS3771 color sensor and a narrow beam Infrared LED.

MSRP – \$17⁰⁰
MIKROE-2103

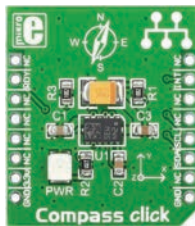

Compass Click

5V 3.3V SPI I2C

UART GPIO PWM AN

It features LSM303DLHC ultra compact high performance e-compass module.

MSRP – \$25⁰⁰
MIKROE-1386

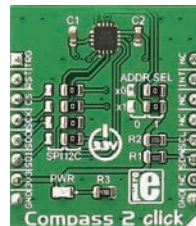

Compass 2 Click

5V 3.3V SPI I2C

UART GPIO PWM AN

With AK8963 3-axis electronic compass based on the Hall effect. 14-/16-bit selectable resolution.

MSRP – \$25⁰⁰
MIKROE-2264

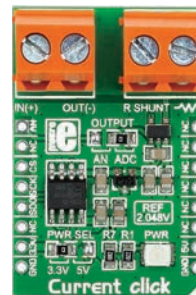

Current Click

5V 3.3V SPI I2C

UART GPIO PWM AN

With INA196 current shunt monitor, MCP3201 12-bit ADC, MAX6106 voltage reference.

MSRP – \$24⁰⁰
MIKROE-1396

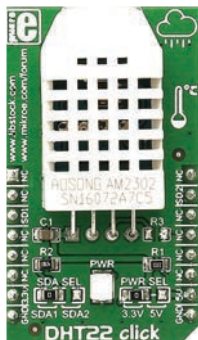

DHT22 Click

5V 3.3V SPI I2C
UART GPIO PWM AN

With DHT22 temp. and humidity measurement sensor. Hum. 0-100%, temp. -40 to +80° C.

MSRP – \$24⁰⁰
MIKROE-1798



Diff pressure Click

5V 3.3V SPI I2C
UART GPIO PWM AN

MPXV5010DP pressure sensor. Designed for comparing 2 pressure measurements.

MSRP – \$59⁰⁰
MIKROE-2387

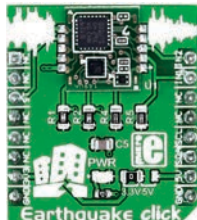

Earthquake Click

5V 3.3V SPI I2C
UART GPIO PWM AN

It carries D7S, the world's smallest high-precision seismic sensor from Omron.

MSRP – \$69⁰⁰
MIKROE-2561



ECG Click

5V 3.3V SPI I2C
UART GPIO PWM AN

It measures the electrical activity of a beating heart through electrodes taped to the skin.

MSRP – \$39⁰⁰
MIKROE-2455



ECG 2 Click

5V 3.3V SPI I2C
UART GPIO PWM AN

Tracks the patterns of your beating heart. It carries ADS1194 16-bit delta-sigma ADC.

MSRP – \$49⁰⁰
MIKROE-2507

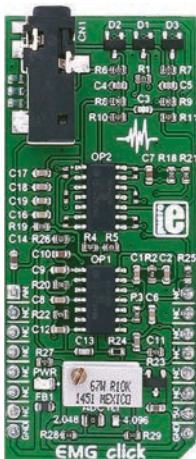

EMG Click

5V | 3.3V | SPI | I2C
 UART | GPIO | PWM | AN

Measures the electrical activity produced by the skeletal muscles.

MSRP – \$29⁰⁰
 MIKROE-2621

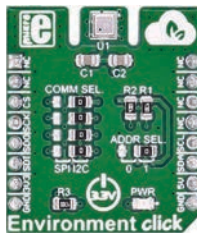

Environment Click

5V | 3.3V | SPI | I2C
 UART | GPIO | PWM | AN

Measures temperature, relative humidity, pressure and Volatile Organic compounds gases.

MSRP – \$34⁰⁰
 MIKROE-2467

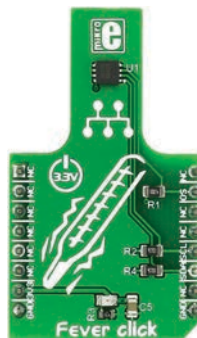

Fever Click

5V | 3.3V | SPI | I2C
 UART | GPIO | PWM | AN

Measures body temperature with MAX30205 sensor. Accuracy 0.1°C [37°C to 39°C].

MSRP – \$11⁰⁰
 MIKROE-2554

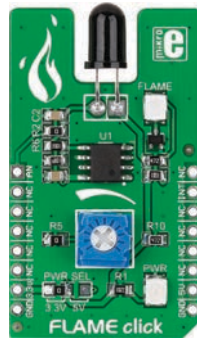

FLAME Click

5V | 3.3V | SPI | I2C
 UART | GPIO | PWM | AN

Used for fire detection. Carries PT334-6B silicon phototransistor sensitive only to infrared light.

MSRP – \$12⁰⁰
 MIKROE-1820

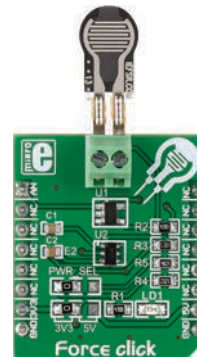

Force Click

5V | 3.3V | SPI | I2C
 UART | GPIO | PWM | AN

With Interlink Electronics' Force Sensing Resistors. Force sensitivity range 0.2N-20N.

MSRP – \$25⁰⁰
 MIKROE-2065

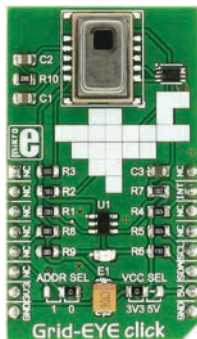

Grid-EYE Click

5V 3.3V SPI I2C

UART GPIO PWM AN

8x8 thermal array sensor-detector that carries AMG8853 infrared array sensor.

MSRP – \$79⁰⁰
MIKROE-2539

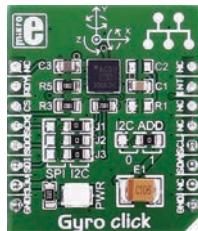

GYRO Click

5V 3.3V SPI I2C

UART GPIO PWM AN

L3GD20 3-axis digital gyroscope module - can measure angular rate and ambient temperature.

MSRP – \$25⁰⁰
MIKROE-1379

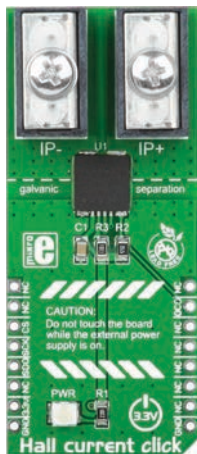

Hall current Click

5V 3.3V SPI I2C

UART GPIO PWM AN

High precision current sensor with TLI4970-D050T4, a magnetic current sensor.

MSRP – \$34⁰⁰
MIKROE-1578

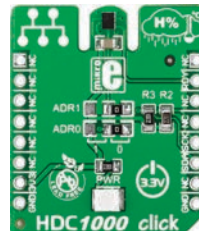

HDC1000 Click

5V 3.3V SPI I2C

UART GPIO PWM AN

It's a humidity [and temperature] measurement Click carrying the HDC1000 sensor.

MSRP – \$19⁰⁰
MIKROE-1797

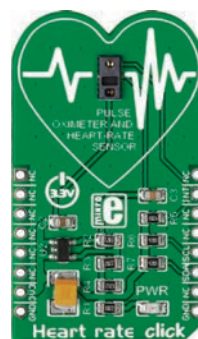

Heart rate Click

5V 3.3V SPI I2C

UART GPIO PWM AN

With Maxim's MAX30100 integrated pulse oximetry and heart-rate sensor.

MSRP – \$19⁰⁰
MIKROE-2000

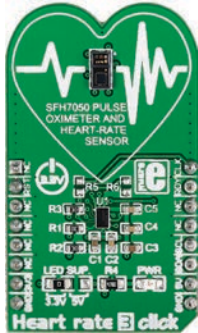

Heart rate 3 Click

5V | 3.3V | SPI | I2C

UART | GPIO | PWM | AN

SFH7050 pulse oximetry and heart rate monitoring module, and AFE4404 IC for bio-sensing.

MSRP – \$39⁰⁰
MIKROE-2036

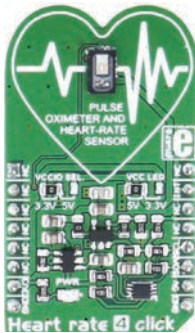

Heart rate 4 Click

5V | 3.3V | SPI | I2C

UART | GPIO | PWM | AN

Carries the MAX30101 high-sensitivity pulse oximeter and heart-rate sensor.

MSRP – \$21⁰⁰
MIKROE-2510

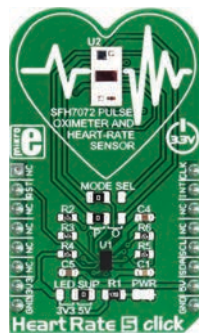

Heart Rate 5 Click

5V | 3.3V | SPI | I2C

UART | GPIO | PWM | AN

Uses the top-of-the-class integrated BIOFY[®] SFH 7072 sensor from OSRAM.

MSRP – \$32⁰⁰
MIKROE-3012



Heart Rate 7 Click

5V | 3.3V | SPI | I2C

UART | GPIO | PWM | AN

The VEMD8080 photo-sensor. A high-speed PD element, with sensitivity in the visible light spectrum.

MSRP – \$23⁰⁰
MIKROE-2998

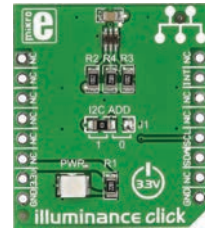

Illuminance Click

5V | 3.3V | SPI | I2C

UART | GPIO | PWM | AN

With TSL2561 light-to-digital converter. Two photodiodes: full-spectrum and infrared light.

MSRP – \$16⁰⁰
MIKROE-1688

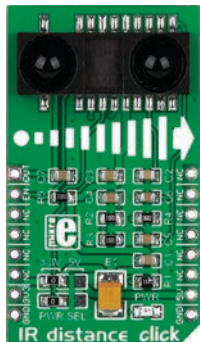

IR distance Click

5V | 3.3V | SPI | I2C
 UART | GPIO | PWM | AN

With GP2Y0A60SZ0F distance measuring sensor. Measuring range 10-150 cm.

MSRP – \$25⁰⁰
 MIKROE-1991

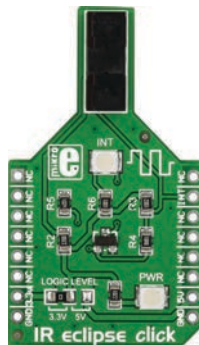

IR eclipse Click

5V | 3.3V | SPI | I2C
 UART | GPIO | PWM | AN

With EE-SX198 photo interrupter sensor - detects anything that obstructs its beam.

MSRP – \$15⁰⁰
 MIKROE-1711

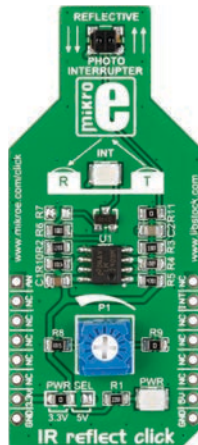

IR reflect Click

5V | 3.3V | SPI | I2C
 UART | GPIO | PWM | AN

Carries GP2S700HCP reflective photo interrupter and an onboard potentiometer.

MSRP – \$12⁰⁰
 MIKROE-1882

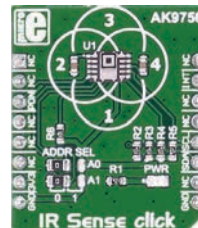

IR Sense Click

5V | 3.3V | SPI | I2C
 UART | GPIO | PWM | AN

With AK9750 quantum-type IR sensor. Detects the temperature of objects and people in motion.

MSRP – \$27⁰⁰
 MIKROE-2677

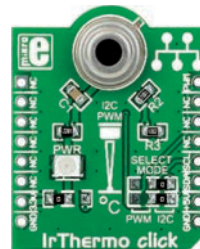

IrThermo Click 3.3V

5V | 3.3V | SPI | I2C
 UART | GPIO | PWM | AN

With MLX90614ESF-BAA IR thermometer module, factory calibrated in wide temperature range.

MSRP – \$29⁰⁰
 MIKROE-1361

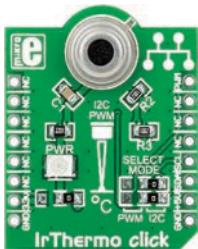

IrThermo Click 5V

5V | 3.3V | SPI | I2C

UART | GPIO | PWM | AN

With MLX90614ESF-AAA IR thermometer module, factory calibrated in wide temperature range.

MSRP – \$29⁰⁰
MIKROE-1362

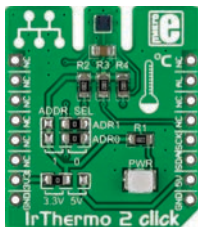

IrThermo 2 Click

5V | 3.3V | SPI | I2C

UART | GPIO | PWM | AN

It is a non-contact temperature measurement solution, with an infrared thermopile sensor.

MSRP – \$20⁰⁰
MIKROE-1888

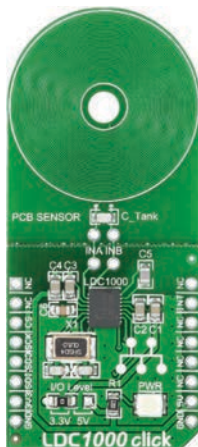

LDC1000 Click

5V | 3.3V | SPI | I2C

UART | GPIO | PWM | AN

With inductance-to-digital converter IC and a detachable sensor. For short range inductive sensing.

MSRP – \$35⁰⁰
MIKROE-1583

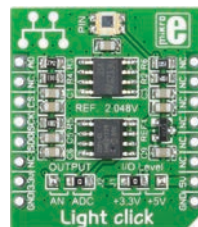

Light Click

5V | 3.3V | SPI | I2C

UART | GPIO | PWM | AN

Used to measure ambient light intensity, with PD15-22CTR8 PIN photodiode.

MSRP – \$18⁰⁰
MIKROE-1424

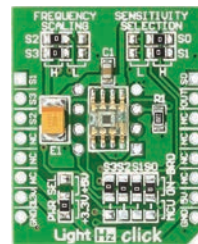

LightHz Click

5V | 3.3V | SPI | I2C

UART | GPIO | PWM | AN

With TSL230BR converter for conversion of light intensity to frequency with no external components.

MSRP – \$17⁹⁰
MIKROE-990

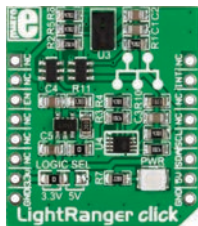

LightRanger Click

5V 3.3V SPI I2C

UART GPIO PWM AN

It's a proximity sensor carrying VL6180X IC. Also works as an ambient light sensor.

MSRP – \$24⁰⁰
MIKROE-1897

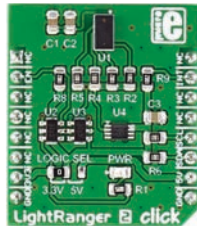

LightRanger 2 Click

5V 3.3V SPI I2C

UART GPIO PWM AN

With VL53L0X IC, the world's smallest Time-of-Flight ranging and gesture detector sensor.

MSRP – \$24⁰⁰
MIKROE-2509

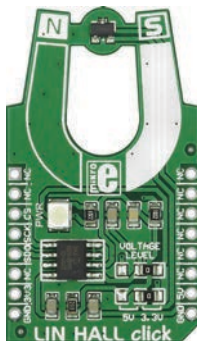

LIN HALL Click

5V 3.3V SPI I2C

UART GPIO PWM AN

Carries MLX90242 linear Hall sensor IC. Measures magnet's strength and distance.

MSRP – \$17⁰⁰
MIKROE-1648

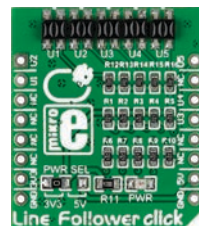

Line Follower Click

5V 3.3V SPI I2C

UART GPIO PWM AN

With five QRE1113 miniature reflective object sensors. Used for line following robots and cars.

MSRP – \$15⁰⁰
MIKROE-1999

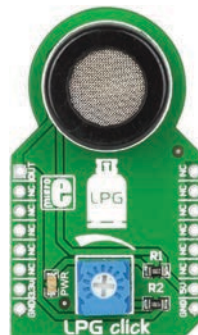

LPG Click

5V 3.3V SPI I2C

UART GPIO PWM AN

With MQ-5 sensor for detecting liquefied petroleum gas leakage. Detection range 200-10000 ppm.

MSRP – \$15⁰⁰
MIKROE-1587

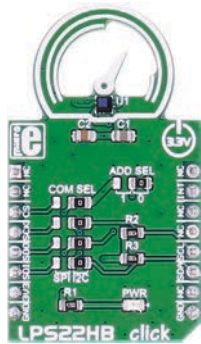

LPS22HB Click

5V | 3.3V | SPI | I2C

UART | GPIO | PWM | AN

Used as a digital barometer. It carries the LPS22HB MEMS nano pressure sensor.

MSRP – \$15⁰⁰
MIKROE-2665

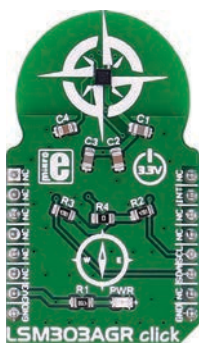

LSM303AGR Click

5V | 3.3V | SPI | I2C

UART | GPIO | PWM | AN

Measures acceleration and magnetic field characteristics. Carries LSM303AGR module.

MSRP – \$18⁰⁰
MIKROE-2684

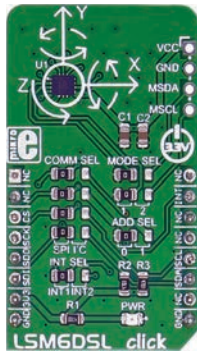

LSM6DSL Click

5V | 3.3V | SPI | I2C

UART | GPIO | PWM | AN

Measures linear and angular velocity with six degrees of freedom. Carries LSM6DSL module.

MSRP – \$15⁰⁰
MIKROE-2731

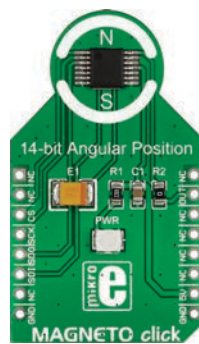

MAGNETO Click

5V | 3.3V | SPI | I2C

UART | GPIO | PWM | AN

Carries AS5048A contactless magnetic angle position sensor that relies on the Hall Effect.

MSRP – \$36⁰⁰
MIKROE-1886

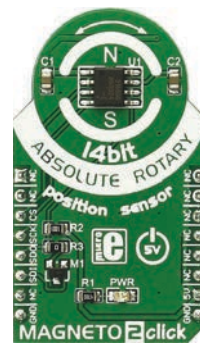

MAGNETO 2 Click

5V | 3.3V | SPI | I2C

UART | GPIO | PWM | AN

Enables the design of non-contacting rotary position sensors with MLX90316 sensor IC.

MSRP – \$29⁰⁰
MIKROE-1938



Manometer Click

5V | 3.3V | SPI | I2C
 UART | GPIO | PWM | AN

Carries a piezoresistive silicon pressure sensor with extremely high accuracy [$\pm 0.25\%$ FSS BFSL].

MSRP – \$79⁰⁰
 MIKROE-2237

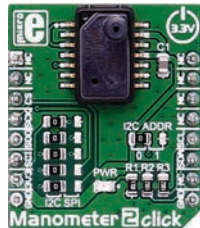

Manometer 2 Click

5V | 3.3V | SPI | I2C
 UART | GPIO | PWM | AN

With MS5525D-S0-SB001GS digital pressure sensor. 24-bit digital pressure and temp. value.

MSRP – \$39⁰⁰
 MIKROE-2550

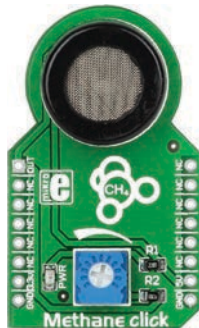

Methane Click

5V | 3.3V | SPI | I2C
 UART | GPIO | PWM | AN

With MQ-4 sensor for methane [CH₄]. Detection range 200-10000ppm of CH₄.

MSRP – \$15⁰⁰
 MIKROE-1628

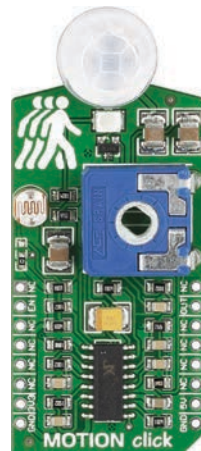

MOTION Click

5V | 3.3V | SPI | I2C
 UART | GPIO | PWM | AN

It's a motion detector sensitive only to live bodies with PIR500B, a pyroelectric sensor.

MSRP – \$13⁰⁰
 MIKROE-1589

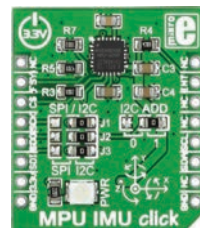

MPU IMU Click

5V | 3.3V | SPI | I2C
 UART | GPIO | PWM | AN

Carries MPU-6000 integrated 6-axis motion tracking device and a DMP [Digital Motion Processor].

MSRP – \$39⁰⁰
 MIKROE-1577



Spectral Click

5V | 3.3V | SPI | I2C

UART | GPIO | PWM | AN

Uses the AS7261, an XYZ chromatic white color sensor + NIR with electronic shutter and smart interface.

MSRP - \$26⁰⁰
MIKROE-2972



Spectral 2 Click

5V | 3.3V | SPI | I2C

UART | GPIO | PWM | AN

Uses the AS7262, 6 channel visible spectral_ID device with electronic shutter and smart Interface.

MSRP - \$26⁰⁰
MIKROE-2973



Spectral 3 Click

5V | 3.3V | SPI | I2C

UART | GPIO | PWM | AN

Uses the AS7263, a 6 channel NIR Spectral_ID device with electronic shutter and smart Interface.

MSRP - \$26⁰⁰
MIKROE-2961



IR Sense 2 Click

5V | 3.3V | SPI | I2C

UART | GPIO | PWM | AN

Uses the AK9752, an ultra-small infrared sensor IC, with an I2C interface, from AKM.

MSRP - \$21⁰⁰
MIKROE-2966



Barcode Click

5V | 3.3V | SPI | I2C

UART | GPIO | PWM | AN

The LV3296, a compact integrated barcode scanner from Rakinda company.

MSRP - \$179⁰⁰
MIKROE-2913

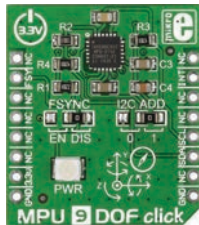

MPU 9DOF Click

5V | 3.3V | SPI | I2C
 UART | GPIO | PWM | AN

Carries the MPU-9150 system in package, the world's first 9-axis motion tracking device.

MSRP – \$42⁰⁰
 MIKROE-1719



Ozone 2 Click

5V | 3.3V | SPI | I2C
 UART | GPIO | PWM | AN

With MQ131 sensor for Ozone [O3]. Detection range 10-1000 ppm of O3.

MSRP – \$37⁰⁰
 MIKROE-2767



Pollution Click

5V | 3.3V | SPI | I2C
 UART | GPIO | PWM | AN

Detects organic gases - formaldehyde, benzene, alcohol, toluene, etc. Detection range 1x50ppm.

MSRP – \$49⁰⁰
 MIKROE-2516

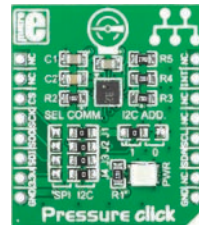

Pressure Click

5V | 3.3V | SPI | I2C
 UART | GPIO | PWM | AN

With LPS331AP digital output pressure sensor. For pressure [260-1260 mbar] and temp. [-40°C to 80°C].

MSRP – \$25⁰⁰
 MIKROE-1422

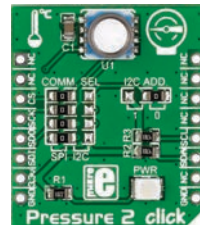

Pressure 2 Click

5V | 3.3V | SPI | I2C
 UART | GPIO | PWM | AN

With MS5803, a high resolution MEMS pressure sensor. Range 0-14 bars, resolution up to 0.2 mbars.

MSRP – \$69⁰⁰
 MIKROE-1880

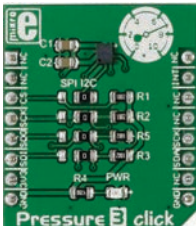

Pressure 3 Click

5V | 3.3V | SPI | I2C
 UART | GPIO | PWM | AN

With DPS310 digital barometric pressure sensor. Range 300-1200 hPa.

MSRP - \$20⁰⁰
 MIKROE-2293

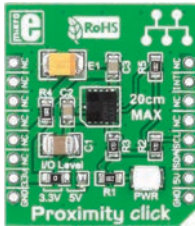

Proximity Click

5V | 3.3V | SPI | I2C
 UART | GPIO | PWM | AN

With VCNL4010 proximity and ambient light sensor. Range up to 20cm, 16-bit resolution.

MSRP - \$17⁰⁰
 MIKROE-1445

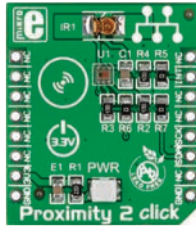

Proximity 2 Click

5V | 3.3V | SPI | I2C
 UART | GPIO | PWM | AN

With MAX44000, an IC that integrates an ambient light and a proximity sensor. Range 0.03-65.535 lux.

MSRP - \$19⁰⁰
 MIKROE-1818

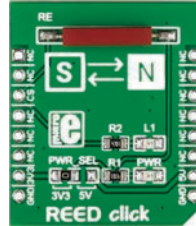

REED Click

5V | 3.3V | SPI | I2C
 UART | GPIO | PWM | AN

With a standard reed switch. Used in mechanical systems as proximity sensors.

MSRP - \$7⁰⁰
 MIKROE-1998

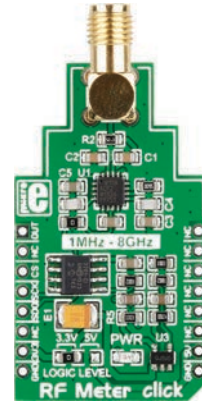

RF Meter Click

5V | 3.3V | SPI | I2C
 UART | GPIO | PWM | AN

It's an RF power measurement device. Frequency span 1 MHz-8 GHz, over 60 dB range.

MSRP - \$44⁰⁰
 MIKROE-2034

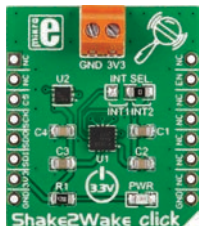

Shake2Wake Click

5V | 3.3V | SPI | I2C
 UART | GPIO | PWM | AN

With ADXL362 ultralow power, 3-axis MEMS accelerometer. Includes several activity detection modes.

MSRP – \$39⁰⁰
 MIKROE-1942

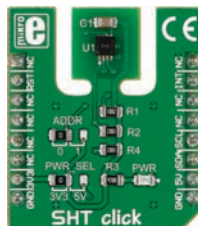

SHT Click

5V | 3.3V | SPI | I2C
 UART | GPIO | PWM | AN

Temperature and humidity sensor SHT3x-DIS. -0 to 100% RH, 40 to 125°C temp. range.

MSRP – \$26⁰⁰
 MIKROE-2101

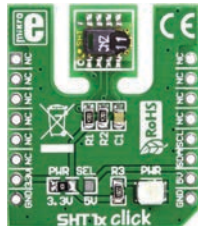

SHT1x Click

5V | 3.3V | SPI | I2C
 UART | GPIO | PWM | AN

Digital humidity and temperature sensor SHT11. Not recommended for newer designs.

MSRP – \$13⁰⁰
 MIKROE-949



Smoke Click

5V | 3.3V | SPI | I2C
 UART | GPIO | PWM | AN

With MAX30105 optical sensor for smoke detection. Sensor's inherent resolution 0.0625°C.

MSRP – \$19⁰⁰
 MIKROE-2560



Stretch Click

5V | 3.3V | SPI | I2C
 UART | GPIO | PWM | AN

Measures stretch forces with conductive rubber cord - 40-160 ohms per cm resistance.

MSRP – \$35⁰⁰
 MIKROE-2064

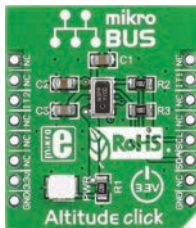

Altitude Click

5V | 3.3V | SPI | I2C
 UART | GPIO | PWM | AN

MEMS pressure sensor MPL3115A2. Pressure/altitude [20-bit] and temp. [12-bit] data.

MSRP – \$14⁰⁰
 MIKROE-1489



THERMO Click

5V | 3.3V | SPI | I2C
 UART | GPIO | PWM | AN

With MAX31855K thermocouple-to-digital converter and PCC-SMP K-type thermocouple connector.

MSRP – \$29⁰⁰
 MIKROE-1197

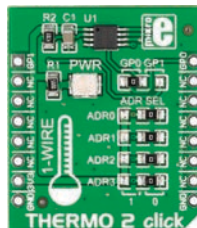

THERMO 2 Click

5V | 3.3V | SPI | I2C
 UART | GPIO | PWM | AN

With DS18B25, a digital thermometer IC with a unique 64-bit address. -10°C to 85°C, ±0.5°C accuracy.

MSRP – \$15⁰⁰
 MIKROE-1840

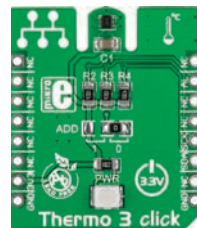

Thermo 3 Click

5V | 3.3V | SPI | I2C
 UART | GPIO | PWM | AN

With TMP102, a digital temp. sensor IC. Accurate within 0.5°C. Range from -25°C to 85°C.

MSRP – \$9⁰⁰
 MIKROE-1885

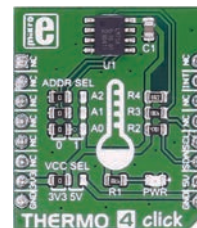

THERMO 4 Click

5V | 3.3V | SPI | I2C
 UART | GPIO | PWM | AN

It carries digital temperature sensor and thermal watchdog. Range from -55 °C to +125 °C.

MSRP – \$9⁰⁰
 MIKROE-2632

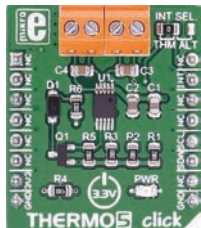

THERMO 5 Click

5V | 3.3V | SPI | I2C

UART | GPIO | PWM | AN

Measures temperature in default range of 0°C to 127°C and extended range of -64°C to 191°C.

MSRP – \$11⁰⁰
MIKROE-2571

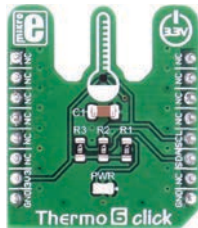

Thermo 6 Click

5V | 3.3V | SPI | I2C

UART | GPIO | PWM | AN

Ambient temp. measurement device, based on the MAX31875 temp. sensor.

MSRP – \$9⁰⁰
MIKROE-2769



THERMO K Click

5V | 3.3V | SPI | I2C

UART | GPIO | PWM | AN

It carries the MCP9600 IC. It can measure temperatures from -200 °C to +1372 °C.

MSRP – \$24⁰⁰
MIKROE-2501



Thermostat Click

5V | 3.3V | SPI | I2C

UART | GPIO | PWM | AN

It carries MAX7502 IC that can measure temp. from -25°C to +100°C. Accuracy ±1.5°C.

MSRP – \$19⁰⁰
MIKROE-2273

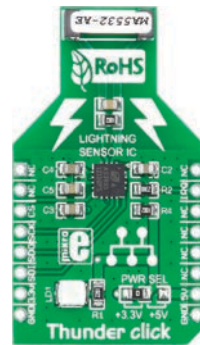

Thunder Click

5V | 3.3V | SPI | I2C

UART | GPIO | PWM | AN

Detects the presence and proximity of lightning activity with AS3935 lightning sensor.

MSRP – \$35⁰⁰
MIKROE-1444

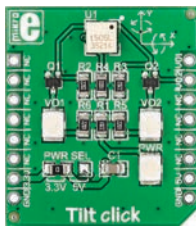

Tilt Click

5V | 3.3V | SPI | I2C

UART | GPIO | PWM | AN

With RPI-1035, a 4-directional optical tilt sensor - left, right, backward, forward movement.

MSRP - \$12⁰⁰
MIKROE-1834

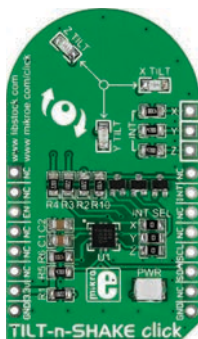

TILTnSHAKE Click

5V | 3.3V | SPI | I2C

UART | GPIO | PWM | AN

With MMA8491Q IC, a 3-axis digital accelerometer. Can function as a 45 ° tilt sensor.

MSRP - \$19⁰⁰
MIKROE-1853

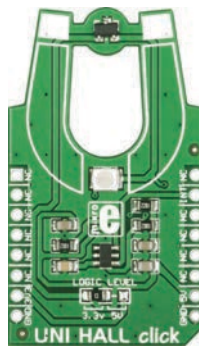

UNI HALL Click

5V | 3.3V | SPI | I2C

UART | GPIO | PWM | AN

With US5881 unipolar Hall-effect switch sensitive to the North Pole magnetic fields.

MSRP - \$12⁰⁰
MIKROE-1647

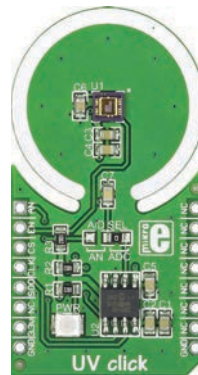

UV Click

5V | 3.3V | SPI | I2C

UART | GPIO | PWM | AN

With ML8511 IC that is sensitive to UVA and UVB rays. Outputs either analog or digital signals.

MSRP - \$24⁰⁰
MIKROE-1677

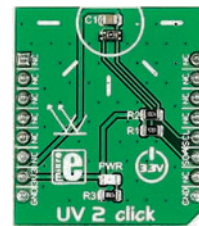

UV 2 Click

5V | 3.3V | SPI | I2C

UART | GPIO | PWM | AN

Carries VEML6075 UVA and UVB light sensor. With a photodiode, amplifiers, analog/digital circuits.

MSRP - \$19⁰⁰
MIKROE-2378

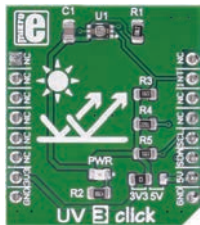

UV 3 Click

5V 3.3V SPI I2C
UART GPIO PWM AN

An advanced ultraviolet (UV) light sensor with VEML6070 UVA light sensor.

MSRP – \$9⁰⁰
MIKROE-2736

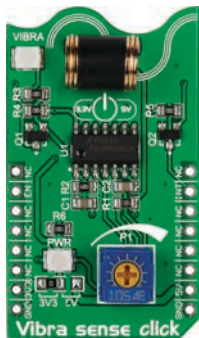

Vibra sense Click

5V 3.3V SPI I2C
UART GPIO PWM AN

A micro shock vibration sensor with a digital output. For anti-tampering, anti-theft devices.

MSRP – \$18⁰⁰
MIKROE-1927

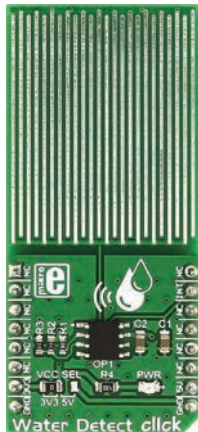

Water Detect Click

5V 3.3V SPI I2C
UART GPIO PWM AN

For detecting water and other electroconductive liquids. Carries Microchip's MCP606.

MSRP – \$9⁰⁰
MIKROE-2786



Weather Click

5V 3.3V SPI I2C
UART GPIO PWM AN

With BME280 integrated environmental unit. Detects humidity, pressure, and temperature.

MSRP – \$22⁰⁰
MIKROE-1978

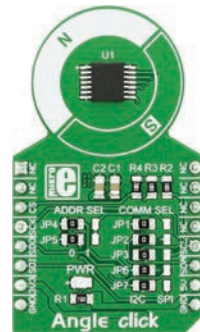

Angle Click

5V 3.3V SPI I2C
UART GPIO PWM AN

Hall-effect angle sensing device used to measure the rotational angle of the magnetic field.

MSRP – \$16⁰⁰
MIKROE-2030



Thermo J Click

5V | 3.3V | SPI | I2C

UART | GPIO | PWM | AN

It is a temperature measurement Click board™, which uses a thermo-couple type-J probe.

MSRP – \$24⁰⁰
MIKROE-2811

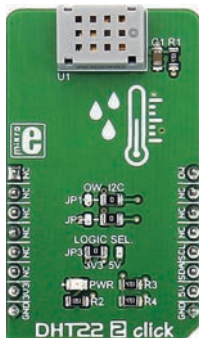

DHT22 2 Click

5V | 3.3V | SPI | I2C

UART | GPIO | PWM | AN

It is used for measuring the environmental temperature and relative humidity.

MSRP – \$22⁰⁰
MIKROE-2818



IrDA 3 Click

5V | 3.3V | SPI | I2C

UART | GPIO | PWM | AN

Intelligent IR transceiver device that sends and receives UART commands via the IR interface.

MSRP – \$26⁰⁰
MIKROE-2871

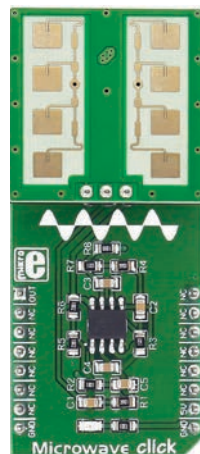

Microwave Click

5V | 3.3V | SPI | I2C

UART | GPIO | PWM | AN

It detects movement, thanks to the PD-V11 a 24GHz microwave motion sensor.

MSRP – \$25⁰⁰
MIKROE-2781



Proximity 3 Click

5V | 3.3V | SPI | I2C

UART | GPIO | PWM | AN

Intelligent proximity and light sensing device - high sensitivity long distance PS and ALS.

MSRP – \$17⁰⁰
MIKROE-2801



Alcohol Click

5V | 3.3V | SPI | I2C
 UART | GPIO | PWM | AN

Detects alcohol in concentrations from 0.04 to 4mg/l with MQ-3 Semiconductor sensor.

MSRP – \$15⁰⁰
 MIKROE-1586

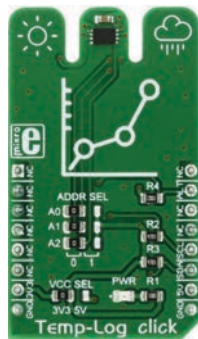

Temp-Log Click

5V | 3.3V | SPI | I2C
 UART | GPIO | PWM | AN

A precise ambient temperature measurement device, with 8Kbit (1024 bytes) of EEPROM memory.

MSRP – \$15⁰⁰
 MIKROE-2886

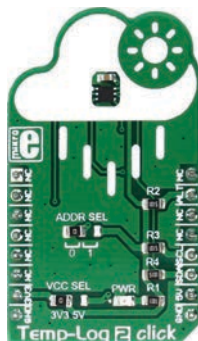

Temp-Log 2 Click

5V | 3.3V | SPI | I2C
 UART | GPIO | PWM | AN

A precise ambient temp. measurement device, with the additional non-volatile [EEPROM] memory.

MSRP – \$15⁰⁰
 MIKROE-3004



HTU21D Click

5V | 3.3V | SPI | I2C
 UART | GPIO | PWM | AN

Carries a relative humidity sensor with temperature output. Rel. hum. 0-100%, temp. -40 to +125° C.

MSRP – \$21⁰⁰
 MIKROE-1687



ProxFusion Click

5V | 3.3V | SPI | I2C
 UART | GPIO | PWM | AN

A multifunctional capacitive and Hall-effect sensor device. Carries the IQS624, a combined multi-sensor IC from Azoteq.

MSRP – \$9⁰⁰
 MIKROE-2920

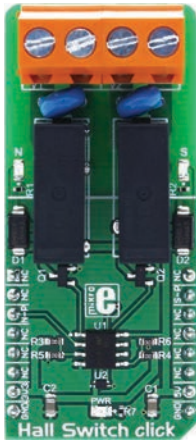

Hall Switch Click

5V 3.3V SPI I2C

UART GPIO PWM AN

Uses the AH1389, an ultra-sensitive dual output unipolar Hall Effect switch, from Diodes Incorporated.

MSRP - \$18⁰⁰
MIKROE-2985



Thermo 7 Click

5V 3.3V SPI I2C

UART GPIO PWM AN

Uses the MCP9800, a high accuracy temperature sensor IC with the 2-Wire interface, from Microchip.

MSRP - \$9⁰⁰
MIKROE-2979

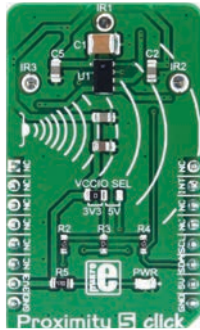

Proximity 5 Click

5V 3.3V SPI I2C

UART GPIO PWM AN

Features the VCN-L4035X01 J, a fully integrated proximity and ambient light sensor.

MSRP - \$15⁰⁰
MIKROE-2984

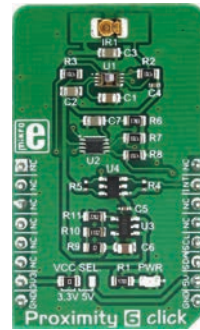

Proximity 6 Click

5V 3.3V SPI I2C

UART GPIO PWM AN

Uses the ADUX1020, a photometric sensor for gesture and proximity detection.

MSRP - \$29⁰⁰
MIKROE-3048



Hall current 2 Click

5V 3.3V SPI I2C

UART GPIO PWM AN

A Hall effect linear current sensor with over-current fault output for less than 100 V Isolation Applications.

MSRP - \$18⁰⁰
MIKROE-2987

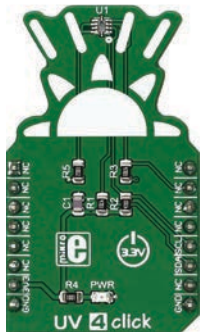

UV 4 Click

5V 3.3V SPI I2C
UART GPIO PWM AN

Equipped with the SI1133, a UV index and ambient light sensor with I2C Interface, from Silicon Labs.

MSRP – \$15⁰⁰
MIKROE-2989

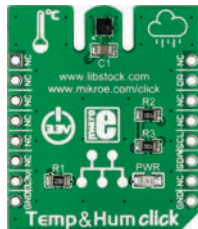

Temp&Hum Click

5V 3.3V SPI I2C
UART GPIO PWM AN

With HTS221 temp. and relative humidity sensor. Measurement accuracy is $\pm 1^\circ\text{C}$ in $0\text{--}60^\circ\text{C}$ range.

MSRP – \$16⁰⁰
MIKROE-1971

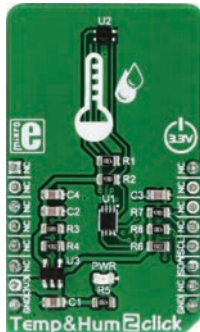

Temp&Hum 2 Click

5V 3.3V SPI I2C
UART GPIO PWM AN

Uses the SI7034, a digital humidity and temperature sensor IC with I2C interface, from Silicon Labs.

MSRP – \$16⁰⁰
MIKROE-3085

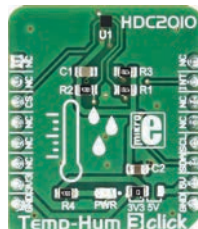

Temp-Hum 3 Click

5V 3.3V SPI I2C
UART GPIO PWM AN

Uses the HDC2010, a Low Power Humidity and Temperature Digital Sensor from Texas Instruments.

MSRP – \$13⁰⁰
MIKROE-2937

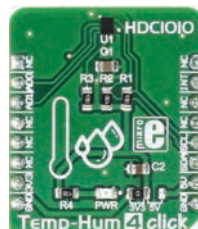

Temp-Hum 4 Click

5V 3.3V SPI I2C
UART GPIO PWM AN

A smart environmental temp. and humidity sensor, uses HDC1010 sensor from Texas Instruments.

MSRP – \$13⁰⁰
MIKROE-2938

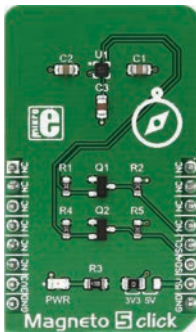

Magneto 5 Click

5V | 3.3V | SPI | I2C

UART | GPIO | PWM | AN

Features the MEMSIC MMC34160PJ, a 3-axis magnetic sensor IC.

MSRP – \$15⁰⁰
MIKROE-3050

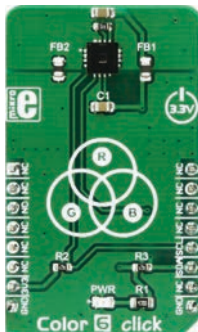

Color 6 Click

5V | 3.3V | SPI | I2C

UART | GPIO | PWM | AN

Features the AMS AS73211, an XYZ true color sensor from AMS.

MSRP – \$32⁰⁰
MIKROE-3061

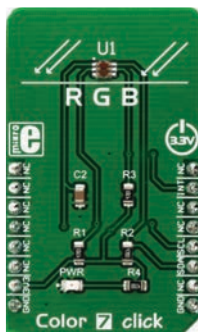

Color 7 Click

5V | 3.3V | SPI | I2C

UART | GPIO | PWM | AN

Features the TCS3472 color light to digital converter with IR filter, from AMS.

MSRP – \$16⁰⁰
MIKROE-3062



Ambient Click

5V | 3.3V | SPI | I2C

UART | GPIO | PWM | AN

With MLX75305 IC, CMOS integrated optical sensor. Converts ambient light intensity into voltage.

MSRP – \$9⁰⁰
MIKROE-1890

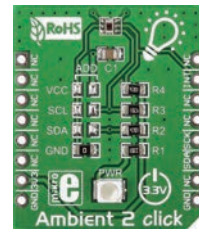

Ambient 2 Click

5V | 3.3V | SPI | I2C

UART | GPIO | PWM | AN

TI's OPT3001 ambient light sensor. Measures the visible part of the light spectrum.

MSRP – \$14⁰⁰
MIKROE-1903

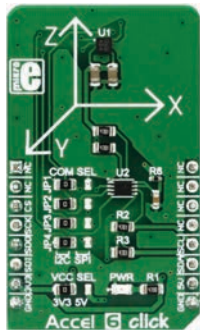

Accel 6 Click

5V | 3.3V | SPI | I2C

UART | GPIO | PWM | AN

The BMA280, a 14bit triaxial acceleration sensor with intelligent on-chip motion triggered interrupt controller.

MSRP – \$17⁰⁰
MIKROE-3075

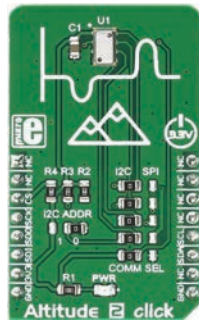

Altitude 2 Click

5V | 3.3V | SPI | I2C

UART | GPIO | PWM | AN

Uses the MS5607-02BA03, a barometric pressure sensor IC with the stainless steel cap.

MSRP – \$15⁰⁰
MIKROE-3030

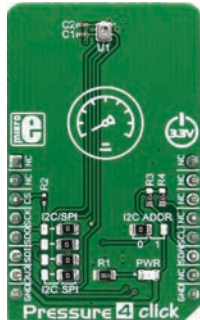

Pressure 4 Click

5V | 3.3V | SPI | I2C

UART | GPIO | PWM | AN

Features the BMP280, a digital pressure sensor, from Bosch Sensortech.

MSRP – \$18⁰⁰
MIKROE-3020

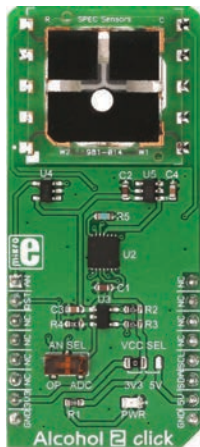

Alcohol 2 Click

5V | 3.3V | SPI | I2C

UART | GPIO | PWM | AN

The BMA280, a 14bit triaxial acceleration sensor with intelligent on-chip motion triggered interrupt controller.

MSRP – \$52⁰⁰
MIKROE-3097



NO2 Click

5V | 3.3V | SPI | I2C

UART | GPIO | PWM | AN

The 3SP-N02-20 gas sensor from SPEC Sensors, which can sense NO2 concentration up to 20ppm.

MSRP – \$52⁰⁰
MIKROE-3098

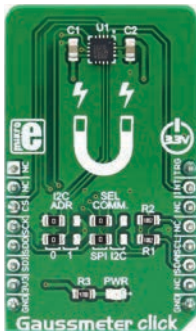

Gaussmeter Click

5V | 3.3V | SPI | I2C

UART | GPIO | PWM | AN

The MLX90393, a micro-power magnetometer based on the proprietary Triaxis® technology.

MSRP – \$19⁰⁰
MIKROE-3099



Oximeter Click

5V | 3.3V | SPI | I2C

UART | GPIO | PWM | AN

The ADPD105, a highly configurable photometric front end (AFE) device from Analog Devices.

MSRP – \$39⁰⁰
MIKROE-3102

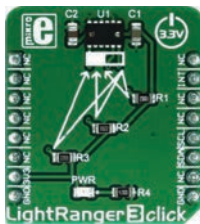

LightRanger 3 Click

5V | 3.3V | SPI | I2C

UART | GPIO | PWM | AN

Uses the Simblee™ enabled RFD77402 ToF sensor module from RF Digital.

MSRP – \$24⁰⁰
MIKROE-3103

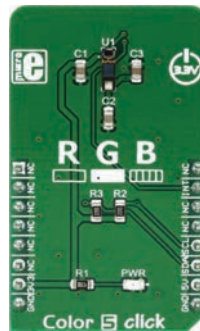

Color 5 Click

5V | 3.3V | SPI | I2C

UART | GPIO | PWM | AN

Uses the P12347-01CT, from Hamamatsu company.

MSRP – \$16⁰⁰
MIKROE-3107

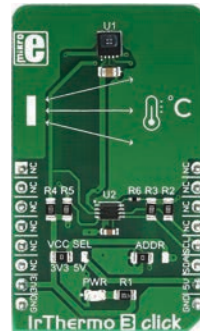

IrThermo 3 Click

5V | 3.3V | SPI | I2C

UART | GPIO | PWM | AN

Uses the MLX90632 FIR sensor from Melexis as the contactless temperature sensor.

MSRP – \$27⁰⁰
MIKROE-3121

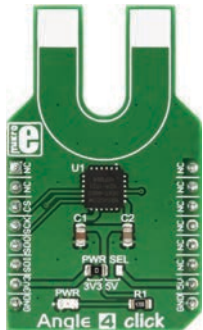

Angle 4 Click

5V 3.3V SPI I2C
UART GPIO PWM AN

With the AEAT-8800-Q24, an integrated 10 to 16-bit programmable angular magnetic encoder.

MSRP – \$26⁰⁰
MIKROE-3130

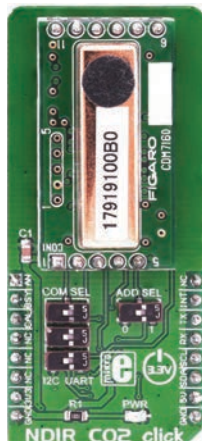

NDIR CO2 Click

5V 3.3V SPI I2C
UART GPIO PWM AN

Uses the CDM7160 integrated sensor and measures an absolute CO2 concentration.

MSRP – \$149⁰⁰
MIKROE-3134



Hall Current 3 Click

5V 3.3V SPI I2C
UART GPIO PWM AN

Uses Hall effect to provide a precise and reliable measurement of reasonably high current.

MSRP – \$19⁰⁰
MIKROE-3118

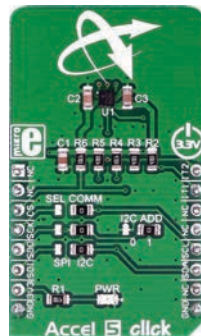

Accel 5 Click

5V 3.3V SPI I2C
UART GPIO PWM AN

Features an ultra-low power triaxial accelerometer sensor, labeled as the BMA400.

MSRP – \$19⁰⁰
MIKROE-3149

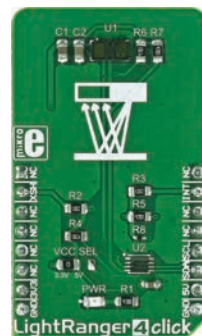

LightRanger 4 Click

5V 3.3V SPI I2C
UART GPIO PWM AN

Measures an accurate distance based on a ToF with VL53L1X rangefinder module.

MSRP – \$24⁰⁰
MIKROE-3176

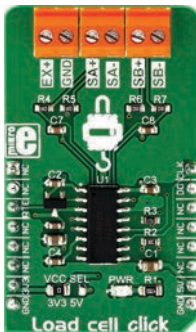

Load cell Click

5V | 3.3V | SPI | I2C

UART | GPIO | PWM | AN

With the HX711, a 24bit analog to digital converter (ADC), for weight scale applications.

MSRP – \$12⁰⁰
MIKROE-3168

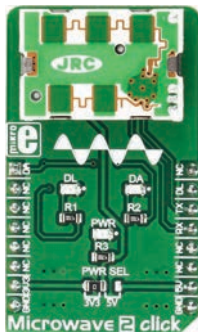

Microwave 2 Click

5V | 3.3V | SPI | I2C

UART | GPIO | PWM | AN

Detects movement by utilizing the NJR4265RF2C1, an intelligent 24GHz microwave motion sensor.

MSRP – \$55⁰⁰
MIKROE-3187

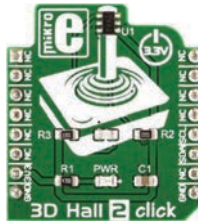

3D Hall 2 Click

5V | 3.3V | SPI | I2C

UART | GPIO | PWM | AN

Measures the magnetic field in three perpendicular axes. With the TLV493D-A1B6, a 3D magnetic sensor.

MSRP – \$15⁰⁰
MIKROE-3190

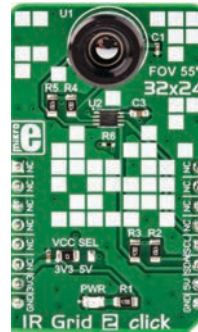

IR Grid 2 Click

5V | 3.3V | SPI | I2C

UART | GPIO | PWM | AN

It is equipped with the MLX90640, a 32x24 IR array sensor which contains 8 Kbit EEPROM.

MSRP – \$75⁰⁰
MIKROE-3194

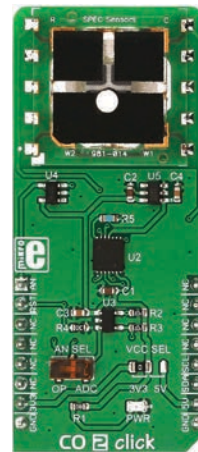

CO 2 Click

5V | 3.3V | SPI | I2C

UART | GPIO | PWM | AN

With the SPEC amperometric, 3SP CO 1000 gas sensor which electrochemically reacts with the [CO].

MSRP – \$52⁰⁰
MIKROE-3196

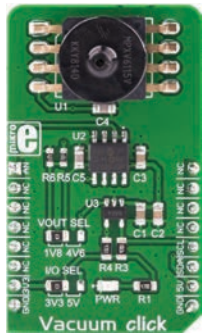

Vacuum Click

5V 3.3V SPI I2C

UART GPIO PWM AN

With the monolithic vacuum sensor the MPXV6115V, it measures pressure values down to -115kPa.

MSRP – \$43⁰⁰
MIKROE-3195

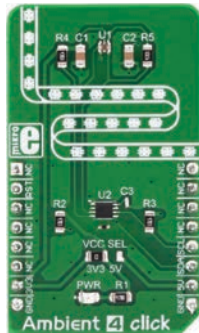

Ambient 4 Click

5V 3.3V SPI I2C

UART GPIO PWM AN

Uses the BH1721FVC, a 16-bit digital light sensor with the I2C serial interface.

MSRP – \$16⁰⁰
MIKROE-3199



3D HALL 5 Click

5V 3.3V SPI I2C

UART GPIO PWM AN

Carries the IIS2MDC-TR, a low power 3D magnetic sensor.

MSRP – \$15⁰⁰
MIKROE-3197



Color 8 Click

5V 3.3V SPI I2C

UART GPIO PWM AN

Features the ROHM's BH1749NUC, an integrated color sensor IC.

MSRP – \$15⁰⁰
MIKROE-3213

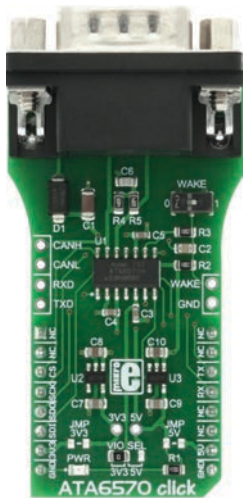

ATA6570 Click

5V | 3.3V | SPI | I2C
 UART | GPIO | PWM | AN

Uses the ATA6570, a standalone high speed CAN transceiver IC from Microchip.

MSRP – \$23⁰⁰
 MIKROE-2900

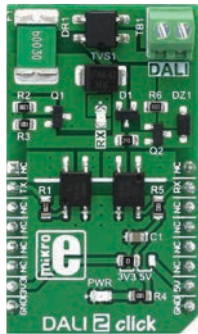

DALI 2 Click

5V | 3.3V | SPI | I2C
 UART | GPIO | PWM | AN

It is used for interfacing with the DALI network, and as a compliant with the DALI-2 physical layer requirements.

MSRP – \$25⁰⁰
 MIKROE-2672

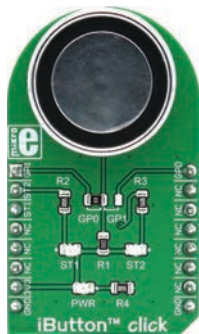

iButton™ Click

5V | 3.3V | SPI | I2C
 UART | GPIO | PWM | AN

Comes with Maxim's DS1990A, a serial number iButton™ device with a unique 64-bit serial number.

MSRP – \$35⁰⁰
 MIKROE-3045

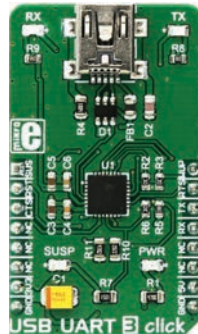

USB UART 3 Click

5V | 3.3V | SPI | I2C
 UART | GPIO | PWM | AN

The CP2102N, a highly integrated USB to UART interface, from Silicon Labs.

MSRP – \$15⁰⁰
 MIKROE-3063

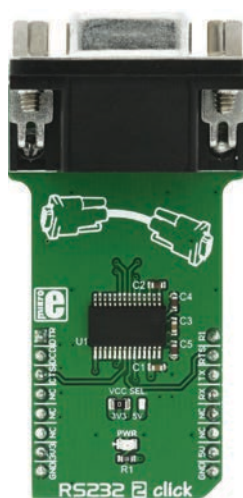

RS232 2 Click

5V | 3.3V | SPI | I2C
 UART | GPIO | PWM | AN

The MAX3237E, a 3V to 5.5V multichannel RS232, 1 Mbit/s line driver/receiver from Texas Instruments.

MSRP – \$15⁰⁰
 MIKROE-2897

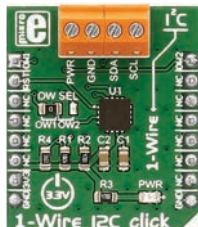

1-Wire I2C Click

5V | 3.3V | SPI | I2C
 UART | GPIO | PWM | AN

Converts I2C to 1-wire with DS28E17 1-Wire-to-I2C master bridge from Maxim Integrated.

MSRP – \$22⁰⁰
 MIKROE-2750

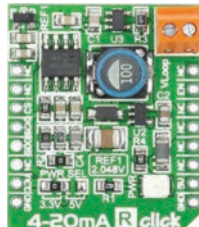

4-20 mA R Click

5V | 3.3V | SPI | I2C
 UART | GPIO | PWM | AN

Serves as a receiver in a 4-20mA current loop standard. Converts it into a voltage [0.4-2V].

MSRP – \$26⁰⁰
 MIKROE-1387



4-20 mA T Click

5V | 3.3V | SPI | I2C
 UART | GPIO | PWM | AN

Easy solution for adding 4-to-20mA industry standard communication protocol to your design.

MSRP – \$26⁰⁰
 MIKROE-1296

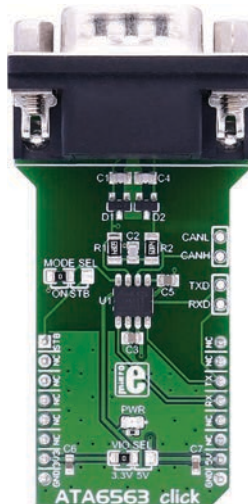

ATA6563 Click

5V | 3.3V | SPI | I2C
 UART | GPIO | PWM | AN

Microchip's ATA6563 high-speed CAN transceiver for Classical CAN and CAN FD networks.

MSRP – \$20⁰⁰
 MIKROE-2334

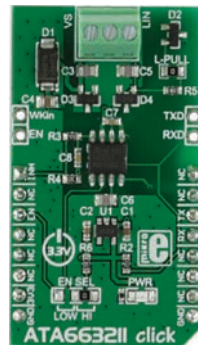

ATA663211 Click

5V | 3.3V | SPI | I2C
 UART | GPIO | PWM | AN

LIN transceiver IC designed to handle low-speed data communication in applications.

MSRP – \$19⁰⁰
 MIKROE-2335

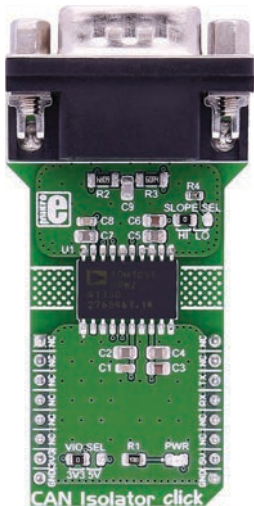

CAN Isolator Click

5V | 3.3V | SPI | I2C
 UART | GPIO | PWM | AN

Provides isolated CAN communication. Data rates of up to 1 Mbps. Carries a DB 9-pin male connector.

MSRP - \$39⁰⁰
 MIKROE-2627



CAN SPI Click 3.3V

5V | 3.3V | SPI | I2C
 UART | GPIO | PWM | AN

Adds CAN connectivity with SPI interface. Features SN65HVD230 CAN transceiver circuit.

MSRP - \$21⁰⁰
 MIKROE-986



CAN SPI Click 5V

5V | 3.3V | SPI | I2C
 UART | GPIO | PWM | AN

Adds CAN connectivity with SPI interface. With MCP2551 CAN transceiver circuit.

MSRP - \$21⁰⁰
 MIKROE-988

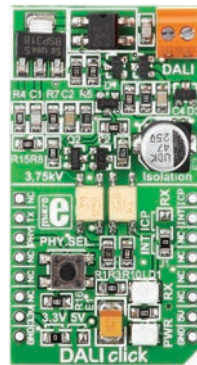

DALI Click

5V | 3.3V | SPI | I2C
 UART | GPIO | PWM | AN

Provides Digital Lighting Interface. With two optocouplers, push button, screw terminal.

MSRP - \$25⁰⁰
 MIKROE-1297



ETH Click

5V | 3.3V | SPI | I2C
 UART | GPIO | PWM | AN

With ENC28J60, a 28-pin, 10BASE-T stand-alone Ethernet controller with an on-board MAC & PHY.

MSRP - \$24⁰⁰
 MIKROE-971



ETH WIZ Click

5V | 3.3V | SPI | I2C
 UART | GPIO | PWM | AN

With W5500, a 48-pin, 10/100 BASE-TX stand-alone Ethernet controller. Standard RJ-45 connector.

MSRP – \$19⁰⁰
 MIKROE-1718

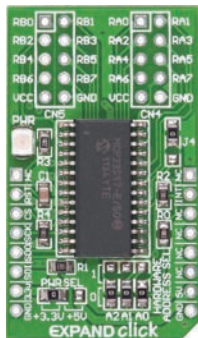

EXPAND Click

5V | 3.3V | SPI | I2C
 UART | GPIO | PWM | AN

Expands the number of input-output lines with Microchip's 16-bit I/O expander MCP23S17.

MSRP – \$12⁰⁰
 MIKROE-951

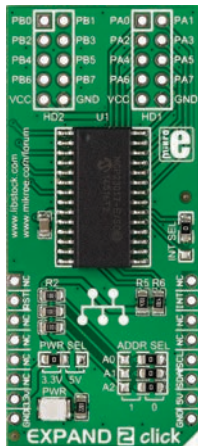

Expand 2 Click

5V | 3.3V | SPI | I2C
 UART | GPIO | PWM | AN

Expands the number of input-output lines with Microchip's 16-bit I/O expander MCP23017.

MSRP – \$12⁰⁰
 MIKROE-1838

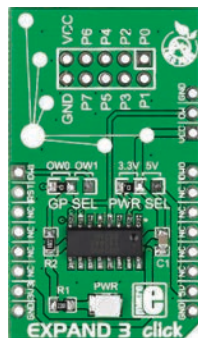

Expand 3 Click

5V | 3.3V | SPI | I2C
 UART | GPIO | PWM | AN

With DS2408, an 8-channel programmable I/O expander from Maxim Integrated.

MSRP – \$19⁰⁰
 MIKROE-1874



EXPAND 4 Click

5V | 3.3V | SPI | I2C
 UART | GPIO | PWM | AN

Port expander for high power peripherals with TPC1C6A595 power logic 8-bit register.

MSRP – \$14⁰⁰
 MIKROE-1910

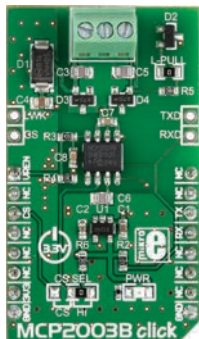

MCP2003B Click

5V | 3.3V | SPI | I2C
 UART | GPIO | PWM | AN

It's a physical interface to automotive and industrial LIN systems with a bi-directional LIN transceiver.

MSRP – \$18⁰⁰
 MIKROE-2227

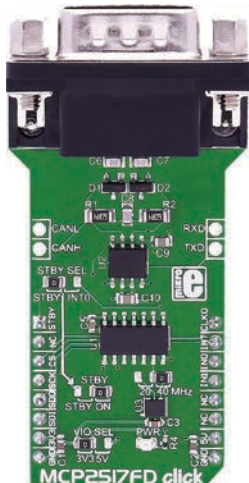

MCP2517FD Click

5V | 3.3V | SPI | I2C
 UART | GPIO | PWM | AN

With MCP2517FD CAN FD controller and ATA6563 high-speed CAN transceiver.

MSRP – \$25⁰⁰
 MIKROE-2379

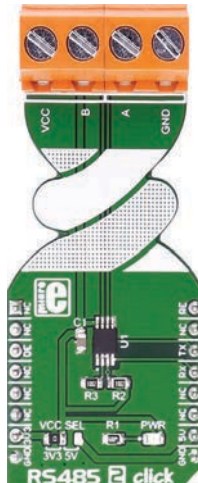

RS485 2 Click

5V | 3.3V | SPI | I2C
 UART | GPIO | PWM | AN

Carries MAX3471 half-duplex transceiver for lithium battery-powered RS-485/RS-422 applications.

MSRP – \$18⁰⁰
 MIKROE-2700

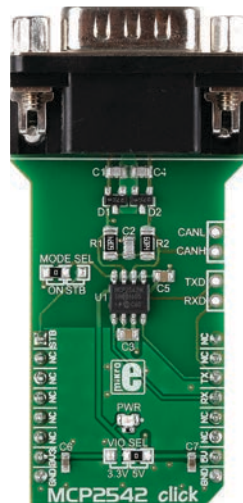

MCP2542 Click

5V | 3.3V | SPI | I2C
 UART | GPIO | PWM | AN

Microchip's CAN FD Transceiver with Wake-Up Pattern. Compliant with CAN 2.0 and CAN FD.

MSRP – \$20⁰⁰
 MIKROE-2299

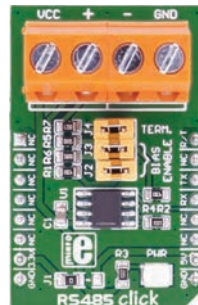

RS485 Click 3.3V

5V | 3.3V | SPI | I2C
 UART | GPIO | PWM | AN

Carries SN-65HVD12 half-duplex, RS-485 transceiver from Texas Instruments.

MSRP – \$18⁰⁰
 MIKROE-989

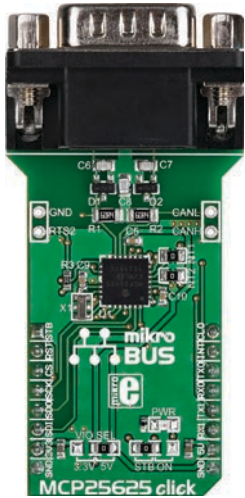

MCP25625 Click

5V 3.3V SPI I2C

UART GPIO PWM AN

With CAN controller with an integrated transceiver. High speed operation up to 1 Mb/s.

MSRP – \$24⁰⁰
MIKROE-2228

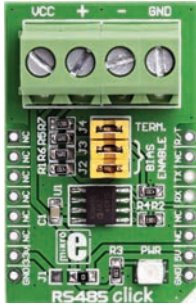

RS485 Click 5V

5V 3.3V SPI I2C

UART GPIO PWM AN

Carries the ADM485 differential line transceiver from Analog Devices.

MSRP – \$18⁰⁰
MIKROE-925

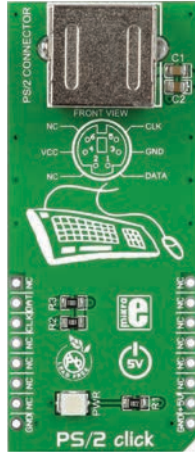

PS/2 Click

5V 3.3V SPI I2C

UART GPIO PWM AN

Adds keyboard and mouse connectivity. With a standard 6-pin Mini-DIN PS/2 connector.

MSRP – \$9⁰⁰
MIKROE-1576

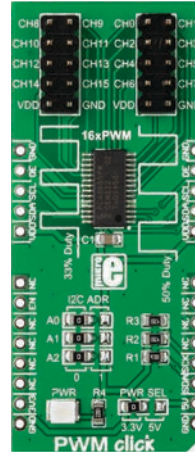

PWM Click

5V 3.3V SPI I2C

UART GPIO PWM AN

For controlling 16 PWM outputs through a single I2C interface. With PCA9685PW IC.

MSRP – \$14⁹⁰
MIKROE-1898

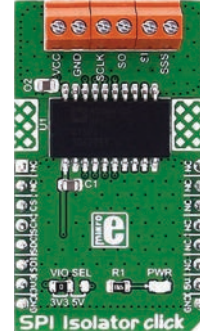

SPI Isolator Click

5V 3.3V SPI I2C

UART GPIO PWM AN

Carries ADuM4154 5kV digital isolator optimized for a serial peripheral interface [SPI].

MSRP – \$29⁰⁰
MIKROE-2583



RS485 Isolator Click

5V | 3.3V | SPI | I2C
 UART | GPIO | PWM | AN

With ADM2682EBRIZ, a 5 kV RMS signal and power isolated RS-485 transceiver.

MSRP - \$49⁰⁰
 MIKROE-2673

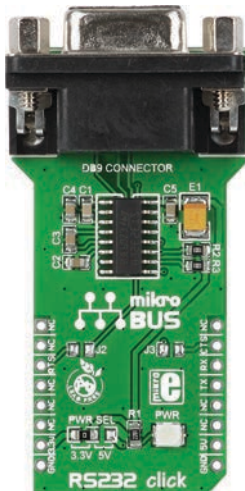

RS232 Click

5V | 3.3V | SPI | I2C
 UART | GPIO | PWM | AN

Adds RS232 connectivity with a standard RS232 DB9 port and a MAX3232 IC.

MSRP - \$15⁰⁰
 MIKROE-1582

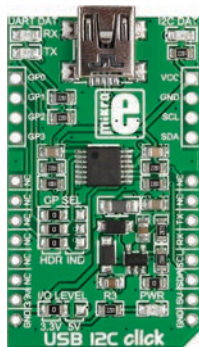

USB I2C Click

5V | 3.3V | SPI | I2C
 UART | GPIO | PWM | AN

With MCP2221 USB-to-UART/I2C converter. Full-speed USB [12 Mb/s], I2C up to 400 kHz clock rates.

MSRP - \$13⁹⁰
 MIKROE-1985

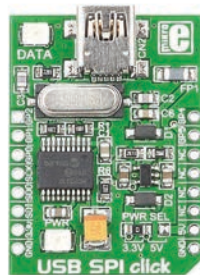

USB SPI Click

5V | 3.3V | SPI | I2C
 UART | GPIO | PWM | AN

Microchip's MCP2210 USB-to-SPI protocol converter with GPIO as well as USB MINI B connector.

MSRP - \$13⁹⁰
 MIKROE-1204



USB UART 2 Click

5V | 3.3V | SPI | I2C
 UART | GPIO | PWM | AN

Provides USB isolation and carries the AD-UM4160BRWZ USB port isolator.

MSRP - \$39⁰⁰
 MIKROE-2674

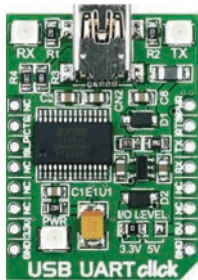

USB UART Click

5V | 3.3V | SPI | I2C
 UART | GPIO | PWM | AN

Adds serial UART communication via USB cable. With FT232RL USB-to-UART interface module.

MSRP – \$13⁹⁰
 MIKROE-1203



ATA663254 Click

5V | 3.3V | SPI | I2C
 UART | GPIO | PWM | AN

It is a fully integrated LIN transceiver device with an integrated 5V LDO voltage regulator.

MSRP – \$16⁹⁰
 MIKROE-2872



BroadR-Reach Click

5V | 3.3V | SPI | I2C
 UART | GPIO | PWM | AN

For realizing network in harsh environments that require reliable Ethernet-based open network.

MSRP – \$69⁹⁰
 MIKROE-2796

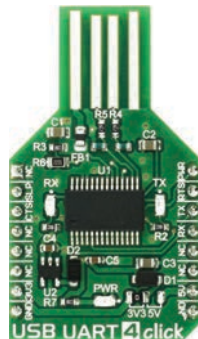

USB UART 4 Click

5V | 3.3V | SPI | I2C
 UART | GPIO | PWM | AN

USB to asynchronous serial data transfer interface. With FT232RL, USB-to-UART interface module.

MSRP – \$13⁹⁰
 MIKROE-2810

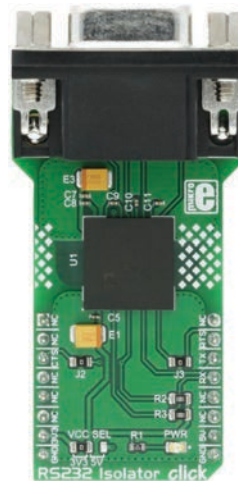

RS232 Isolator Click

5V | 3.3V | SPI | I2C
 UART | GPIO | PWM | AN

Isolated dual transceiver Click - secure and easy UART to RS232 conversion, with galvanic isolation.

MSRP – \$56⁰⁰
 MIKROE-2864

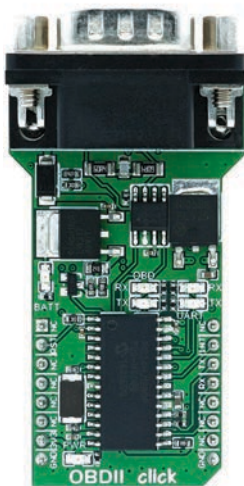

OBDII Click

5V | 3.3V | SPI | I2C
 UART | GPIO | PWM | AN

Tap inside the car diagnostic systems! Features the STN1110 Multiprotocol OBD to UART Interface.

MSRP – \$47⁹⁰
 MIKROE-2452

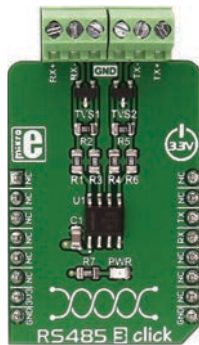

RS485 3 Click

5V | 3.3V | SPI | I2C
 UART | GPIO | PWM | AN

The Click is intended to be used as UART to RS422/RS485 communication interface.

MSRP – \$20⁰⁰
 MIKROE-2821



PWM 2 Click

5V | 3.3V | SPI | I2C
 UART | GPIO | PWM | AN

With the LT8500, a 48-Channel LED PWM generator with 12-Bit res. and 50MHz serial interface.

MSRP – \$19⁰⁰
 MIKROE-3148

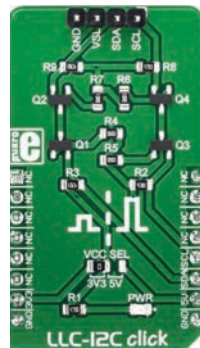

LLC-I2C Click

5V | 3.3V | SPI | I2C
 UART | GPIO | PWM | AN

Used as the level converter for logic signals. It is perfectly suited for the bi-directional I2C communication.

MSRP – \$9⁰⁰
 MIKROE-3276

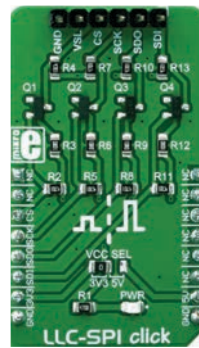

LLC-SPI Click

5V | 3.3V | SPI | I2C
 UART | GPIO | PWM | AN

Used as the level converter for logic signals. It is perfectly suited for SPI communication.

MSRP – \$9⁰⁰
 MIKROE-3298

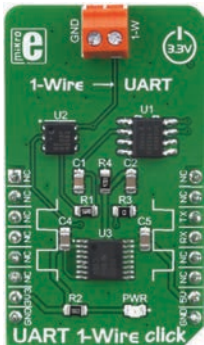

UART 1-Wire Click

5V 3.3V SPI I2C

UART:GPIO:PWM:AN

Designed to convert standard UART or RS232 signals into 1-Wire® signals.

MSRP – \$22⁰⁰
MIKROE-3340



4D - display Click

5V 3.3V SPI I2C

UART:GPIO:PWM:AN

Offers a mikroBUS™ interface for controlling 4D Systems gen4 Series intelligent Display Modules.

MSRP – \$9⁰⁰
MIKROE-3044



Skywire™ Click

5V 3.3V SPI I2C

UART:GPIO:PWM:AN

Adapter Click, which hosts NimbeLink/Skywire™ cellular modems [using stacking headers].

MSRP – \$19⁰⁰
MIKROE-2405

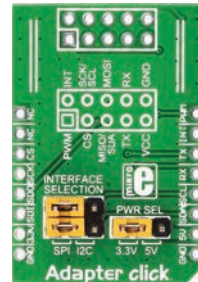

Adapter Click

5V 3.3V SPI I2C

UART:GPIO:PWM:AN

Simplifies connection of the add-on boards with IDC10 headers to mikroBUS™ socket.

MSRP – \$6⁵⁰
MIKROE-1432



Riverdi Click

5V 3.3V SPI I2C

UART:GPIO:PWM:AN

An adapter for connecting Riverdi TFT displays to a mikroBUS™ socket.

MSRP – \$9⁰⁰
MIKROE-2100

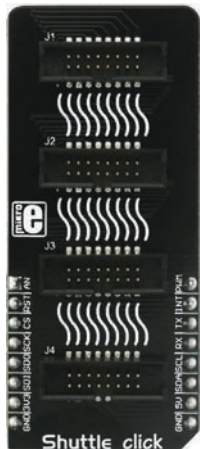

Shuttle Click

5V 3.3V SPI I2C
UART GPIO PWM AN

The mikroBUS™ socket expansion board, which allows stacking up to four Click boards™.

MSRP – \$8⁰⁰
MIKROE-2880

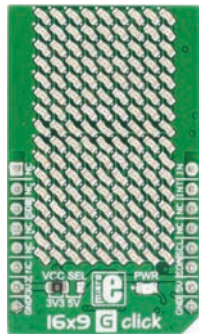

16x9 G Click

5V 3.3V SPI I2C
UART GPIO PWM AN

With a green 16x9 LED matrix and IS31FL3731 audio modulated matrix LED driver.

MSRP – \$34⁰⁰
MIKROE-2520

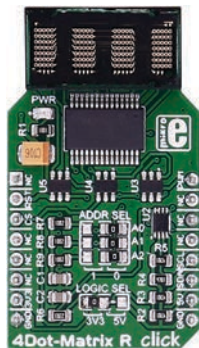

4Dot-Matrix R Click

5V 3.3V SPI I2C
UART GPIO PWM AN

Displays 4 char. of 5x7 dot size. With SLO2016 module and MCP23017 I2C port expander.

MSRP – \$59⁰⁰
MIKROE-2706

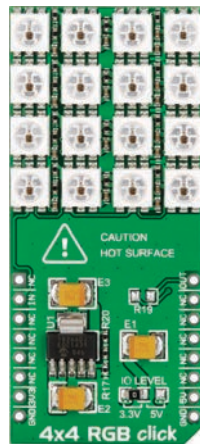

4x4 RGB Click

5V 3.3V SPI I2C
UART GPIO PWM AN

With a matrix of 16 WS2812 RGB LEDs a MCP1826 low dropout regulator.

MSRP – \$19⁰⁰
MIKROE-1881

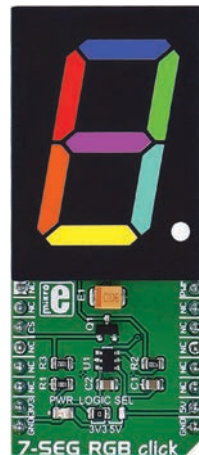

7-SEG RGB Click

5V 3.3V SPI I2C
UART GPIO PWM AN

Carries a full color single 7 segment dig-it display. 16,581,375 color combinations.

MSRP – \$29⁰⁰
MIKROE-2734

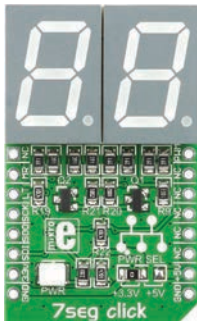

7seg Click

5V | 3.3V | SPI | I2C

UART | GPIO | PWM | AN

2-digit seven-seg display.
With two 74HC595 8-bit serial-in, parallel-out shift registers.

MSRP – \$10⁰⁰
MIKROE-1201

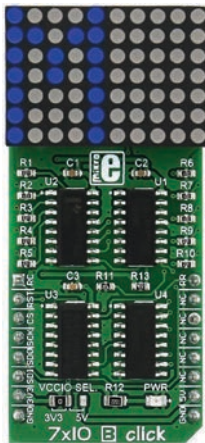

7x10 B Click

5V | 3.3V | SPI | I2C

UART | GPIO | PWM | AN

With a matrix of 70 blue LEDs driven by a pair of 8-bit serial-in, parallel-out shift registers.

MSRP – \$15⁰⁰
MIKROE-2789

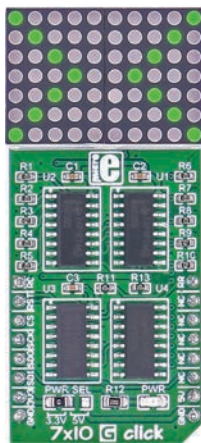

7x10 G Click

5V | 3.3V | SPI | I2C

UART | GPIO | PWM | AN

With a matrix of 70 green LEDs driven by a pair of 8-bit serial-in, parallel-out shift registers.

MSRP – \$15⁰⁰
MIKROE-2705

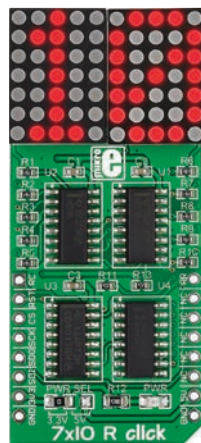

7x10 R Click

5V | 3.3V | SPI | I2C

UART | GPIO | PWM | AN

With a matrix of 70 red LEDs driven by a pair of 8-bit serial-in, parallel-out shift registers.

MSRP – \$15⁰⁰
MIKROE-1993

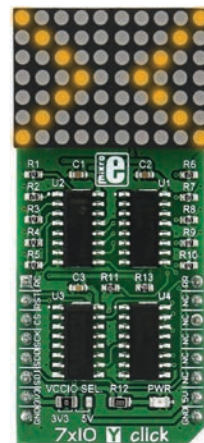

7x10 Y Click

5V | 3.3V | SPI | I2C

UART | GPIO | PWM | AN

With a matrix of 70 yellow LEDs driven by a pair of 8-bit serial-in, parallel-out shift registers.

MSRP – \$15⁰⁰
MIKROE-2790



16x12 G Click

5V 3.3V SPI I2C
UART GPIO PWM AN

Carries a 16x12 LED display and the IS-31FL3733 matrix driver with 1/12 cycle rate.

MSRP – \$30⁰⁰
MIKROE-2758

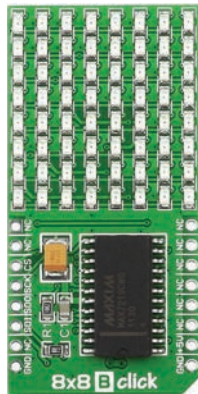

8x8 B Click

5V 3.3V SPI I2C
UART GPIO PWM AN

It features MAX7219 8-digit LED display driver module as well as 64 BLUE LEDs.

MSRP – \$18⁰⁰
MIKROE-1307

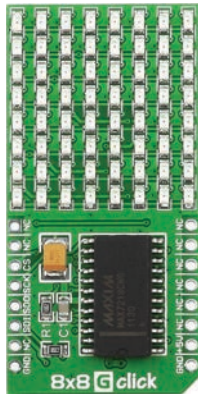

8x8 G Click

5V 3.3V SPI I2C
UART GPIO PWM AN

It features MAX7219 8-digit LED display driver module as well as 64 GREEN LEDs.

MSRP – \$15⁰⁰
MIKROE-1306

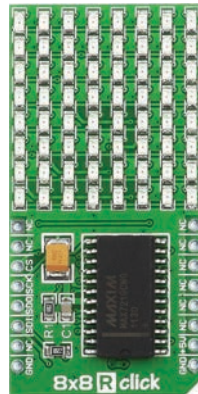

8x8 R Click

5V 3.3V SPI I2C
UART GPIO PWM AN

It features MAX7219 8-digit LED display driver module as well as 64 RED LEDs.

MSRP – \$15⁰⁰
MIKROE-1285

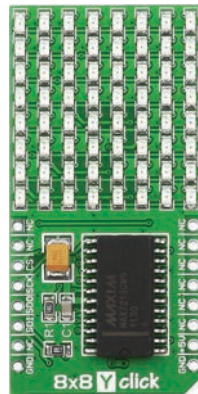

8x8 Y Click

5V 3.3V SPI I2C
UART GPIO PWM AN

It features MAX7219 8-digit LED display driver module as well as 64 YELLOW LEDs.

MSRP – \$15⁰⁰
MIKROE-1294

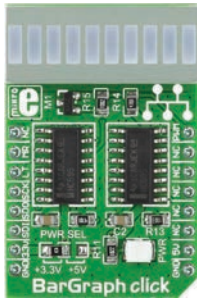

BarGraph Click

5V 3.3V SPI I2C

UART GPIO PWM AN

With 10-segment JSB-R102510Z light bar display and two 74HC595 95 8-bit shift registers.

MSRP – \$12⁰⁰
MIKROE-1423



BIG 7-SEG R Click

5V 3.3V SPI I2C

UART GPIO PWM AN

With SC10-21SR-WA seven-segment display and parallel-OUT shift register 74HC595.

MSRP – \$19⁰⁰
MIKROE-2269

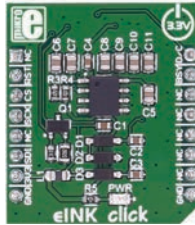

eINK Click

5V 3.3V SPI I2C

UART GPIO PWM AN

With an adapter for connecting eInk displays, with a 24pin ribbon cable.

MSRP – \$59⁰⁰
MIKROE-2659



EVE Click

5V 3.3V SPI I2C

UART GPIO PWM AN

Brings visually stunning graphics even to 8-bit MCUs, with FT800Q graphics controller.

MSRP – \$39⁰⁰
MIKROE-1430

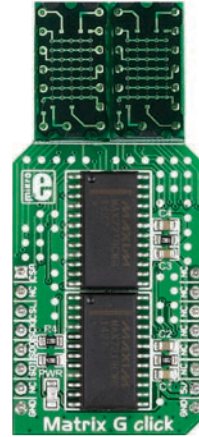

Matrix G Click

5V 3.3V SPI I2C

UART GPIO PWM AN

Matrix text display with two green 5x7 matrices and two MAX7219 8-bit LED display drivers.

MSRP – \$29⁰⁰
MIKROE-2246

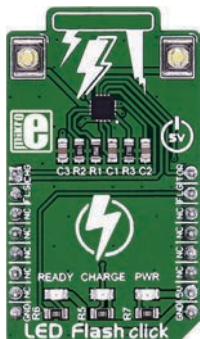

LED Flash Click

5V 3.3V SPI I2C
UART GPIO PWM AN

Functions as a high power LED flash, and carries the CAT3224 flash LED driver.

MSRP – \$34⁰⁰
MIKROE-2479

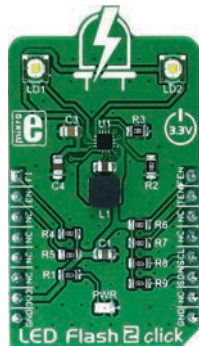

LED Flash 2 Click

5V 3.3V SPI I2C
UART GPIO PWM AN

It is a powerful flash/torch Click, featuring the MIC2870 from Microchip.

MSRP – \$19⁰⁰
MIKROE-2830

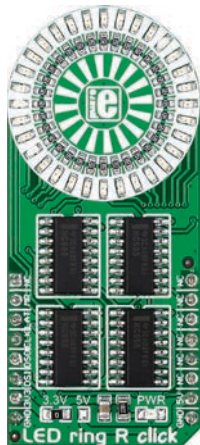

LED ring R Click

5V 3.3V SPI I2C
UART GPIO PWM AN

With a ring of 32 red LEDs driven by four 74HC595 serial-in, parallel-out shift registers.

MSRP – \$16⁰⁰
MIKROE-2155

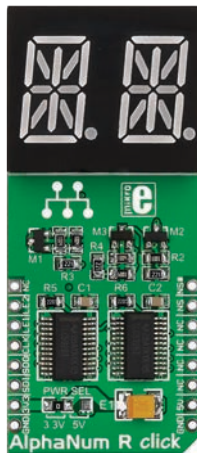

AlphaNum R Click

5V 3.3V SPI I2C
UART GPIO PWM AN

With a dual character red LED 14-segment display and two TLC5926 16-bit shift registers.

MSRP – \$15⁰⁰
MIKROE-1864

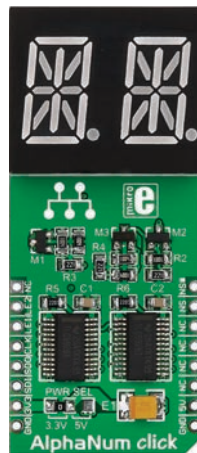

AlphaNum G Click

5V 3.3V SPI I2C
UART GPIO PWM AN

With a dual character green LED 14-segment display and two TLC5926 16-bit shift registers.

MSRP – \$15⁰⁰
MIKROE-1851



Matrix R Click

5V | 3.3V | SPI | I2C

UART | GPIO | PWM | AN

Matrix text display with two red 5x7 matrices and two MAX7219 8-bit LED display drivers.

MSRP – \$29⁰⁰
MIKROE-2245

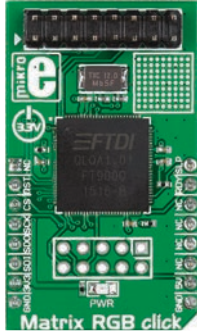

Matrix RGB Click

5V | 3.3V | SPI | I2C

UART | GPIO | PWM | AN

Powered by a 32-bit FT900 MCU designed specifically for powering 16x32 RGB LED matrices.

MSRP – \$24⁰⁰
MIKROE-2239

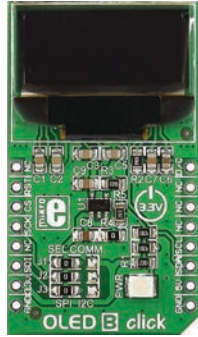

OLED B Click

5V | 3.3V | SPI | I2C

UART | GPIO | PWM | AN

With a 96 x 39px blue monochrome passive matrix OLED display and SSD1306 controller.

MSRP – \$24⁰⁰
MIKROE-1650



OLED C Click

5V | 3.3V | SPI | I2C

UART | GPIO | PWM | AN

With PSP27801 OLED display and SSD1351 OLED driver with controller. Various color support.

MSRP – \$29⁰⁰
MIKROE-1585

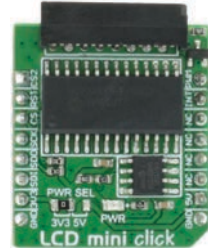

LCD mini Click

5V | 3.3V | SPI | I2C

UART | GPIO | PWM | AN

Displays 2x16 monochrome characters on an LMB162XFW LCD display.

MSRP – \$19⁰⁰
MIKROE-2453

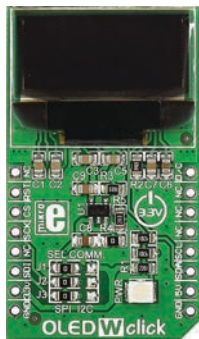

OLED W Click

5V 3.3V SPI I2C

UART GPIO PWM AN

Carries a 96x39px white monochrome passive matrix OLED display.

MSRP - \$24⁰⁰
MIKROE-1649

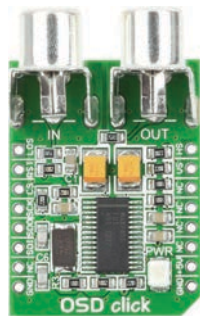

OSD Click

5V 3.3V SPI I2C

UART GPIO PWM AN

With MAX7456 single-channel monochrome OSD module with integrated EEPROM memory.

MSRP - \$35⁰⁰
MIKROE-1366

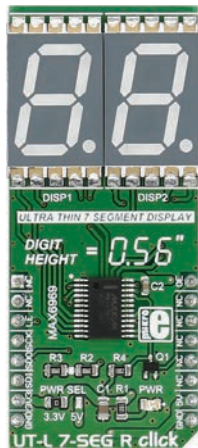

UT-L 7-SEG R Click

5V 3.3V SPI I2C

UART GPIO PWM AN

With two SMD ultra-thin LED 7-SEG displays and MAX6969 constant-current LED driver.

MSRP - \$44⁰⁰
MIKROE-2034

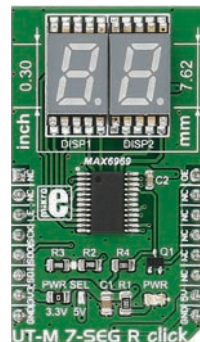

UT-M 7-SEG R Click

5V 3.3V SPI I2C

UART GPIO PWM AN

Add a double 7 segment display to your next project. RED emitting color.

MSRP - \$20⁰⁰
MIKROE-2746

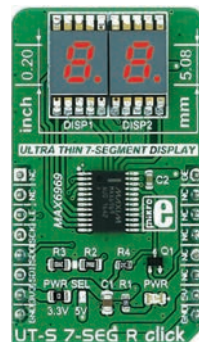

UT-S 7-SEG R Click

5V 3.3V SPI I2C

UART GPIO PWM AN

For displaying characters on two 7 segment displays. RED emitting color.

MSRP - \$20⁰⁰
MIKROE-2840



OLED Switch Click

5V | 3.3V | SPI | I2C
 UART | GPIO | PWM | AN

With NKK Switch IS-C15ANP4 that combines a switch and a full color organic LED display.

MSRP – \$99⁰⁰
 MIKROE-2449

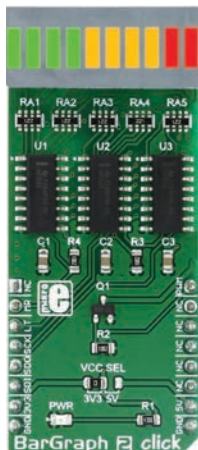

BarGraph 2 Click

5V | 3.3V | SPI | I2C
 UART | GPIO | PWM | AN

The 74HC595, 8-bit serial-in, parallel-out shift registers with output latches.

MSRP – \$19⁰⁰
 MIKROE-3021

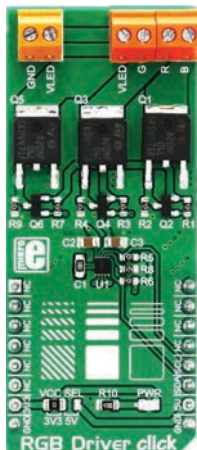

RGB Driver Click

5V | 3.3V | SPI | I2C
 UART | GPIO | PWM | AN

The NCP5623B, a triple output RGB LED driver, controlled via the I2C interface, from ON Semiconductors.

MSRP – \$15⁰⁰
 MIKROE-3078

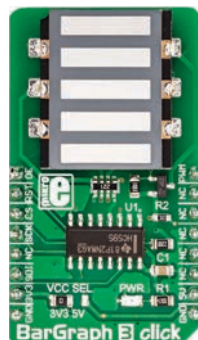

BarGraph 3 Click

5V | 3.3V | SPI | I2C
 UART | GPIO | PWM | AN

Uses a single 74HC595 IC, a tri-state, serial-in, parallel-out, 8-bit shift-register with output latch.

MSRP – \$15⁰⁰
 MIKROE-3264

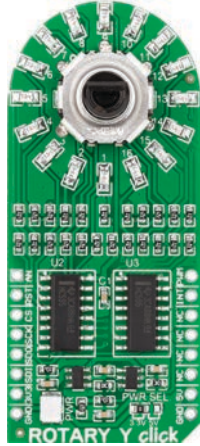

ROTARY Y Click

5V 3.3V SPI I2C
UART GPIO PWM AN

With a 15-pulse incremental rotary encoder with detents, surrounded by a ring of 16 yellow LEDs.

MSRP – \$12⁰⁰
MIKROE-1825

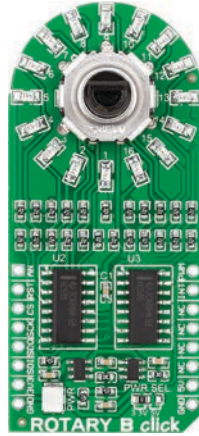

ROTARY B Click

5V 3.3V SPI I2C
UART GPIO PWM AN

With a 15-pulse incremental rotary encoder with detents, surrounded by a ring of 16 blue LEDs.

MSRP – \$12⁰⁰
MIKROE-1824

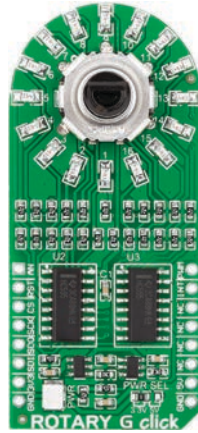

ROTARY G Click

5V 3.3V SPI I2C
UART GPIO PWM AN

With a 15-pulse incremental rotary encoder with detents, surrounded by a ring of 16 green LEDs.

MSRP – \$12⁰⁰
MIKROE-1822

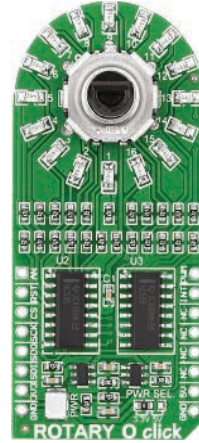

ROTARY O Click

5V 3.3V SPI I2C
UART GPIO PWM AN

With a 15-pulse incremental rotary encoder with detents, surrounded by a ring of 16 orange LEDs.

MSRP – \$12⁰⁰
MIKROE-2380

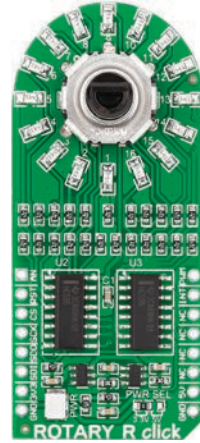

ROTARY R Click

5V 3.3V SPI I2C
UART GPIO PWM AN

With a 15-pulse incremental rotary encoder with detents, surrounded by a ring of 16 red LEDs.

MSRP – \$12⁰⁰
MIKROE-1823



CapSense Click

5V 3.3V SPI I2C

UART GPIO PWM AN

Capacitive sensing module. Input- human body capacitance, output - the real time sensor information.

MSRP - \$16⁰⁰
MIKROE-1446

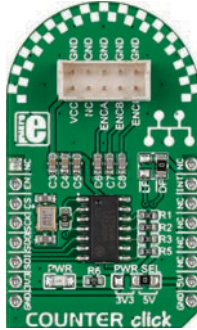

COUNTER Click

5V 3.3V SPI I2C

UART GPIO PWM AN

Counter Click carries an LS7366R 32-bit quadrature counter.

MSRP - \$25⁰⁰
MIKROE-1917



FingerPrint Click

5V 3.3V SPI I2C

UART GPIO PWM AN

Solution for adding biometric security to your design.

MSRP - \$55⁰⁰
MIKROE-1722

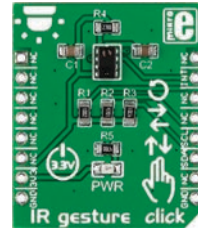

IR gesture Click

5V 3.3V SPI I2C

UART GPIO PWM AN

Enables contactless gesture recognition. With ambient light and proximity sensing capabilities.

MSRP - \$16⁰⁰
MIKROE-2086

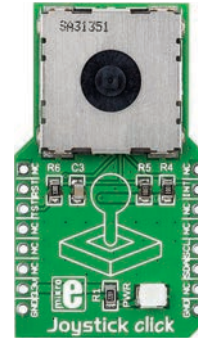

Joystick Click

5V 3.3V SPI I2C

UART GPIO PWM AN

A smart navigation key concept based on contactless, magnetic movement detection.

MSRP - \$22⁰⁰
MIKROE-1506

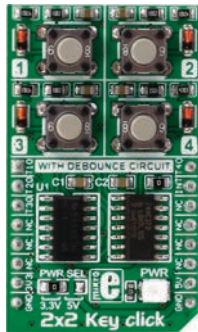

2x2 Key Click

5V 3.3V SPI I2C
UART GPIO PWM AN

The Click has a 4 button keypad. It allows multiple key presses and has a debounce circuit.

MSRP – \$9⁰⁰
MIKROE-2152

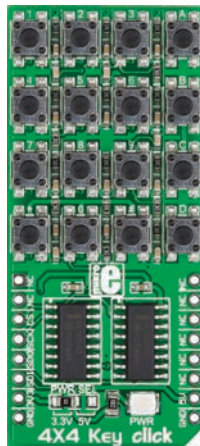

4x4 Key Click

5V 3.3V SPI I2C
UART GPIO PWM AN

Carries a 16 button keypad. Allows for multiple key presses at the same time.

MSRP – \$11⁰⁰
MIKROE-1889



Button G Click

5V 3.3V SPI I2C
UART GPIO PWM AN

A single pushbutton - transparent, 6.8mm in diameter, with a green LED backlight.

MSRP – \$9⁰⁰
MIKROE-2040



Button R Click

5V 3.3V SPI I2C
UART GPIO PWM AN

A single pushbutton - transparent, 6.8mm in diameter, with a red LED backlight.

MSRP – \$9⁰⁰
MIKROE-1901



Cap Extend Click

5V 3.3V SPI I2C
UART GPIO PWM AN

With SX8633, capacitive button touch controller. 12 pins for connecting capacitive inputs.

MSRP – \$18⁰⁰
MIKROE-2238

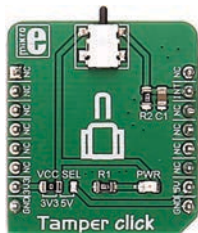

Tammer Click

5V | 3.3V | SPI | I2C
 UART | GPIO | PWM | AN

Equipped with SDS001, a low profile side-actuated detect switch.

MSRP – \$9⁰⁰
 MIKROE-2551

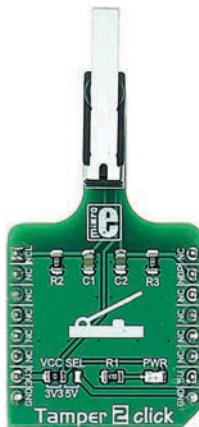

Tammer 2 Click

5V | 3.3V | SPI | I2C
 UART | GPIO | PWM | AN

Levered D2HW-A221D switch. Outputs signal in both positions - pressed and released.

MSRP – \$15⁰⁰
 MIKROE-2552



Thumb wheel Click

5V | 3.3V | SPI | I2C
 UART | GPIO | PWM | AN

With a 10-position rotary sprocket connected to a 1-Wire 8-Channel Addressable Switch.

MSRP – \$29⁰⁰
 MIKROE-2366



TouchClamp Click

5V | 3.3V | SPI | I2C
 UART | GPIO | PWM | AN

With NXP's MPR121 proximity capacitive touch sensor controller. 7 plated holes for clamps.

MSRP – \$9⁰⁰
 MIKROE-2294



Keylock Click

5V | 3.3V | SPI | I2C
 UART | GPIO | PWM | AN

Carries a processed sealed key lock mechanism that can be set in 3 different positions.

MSRP – \$25⁰⁰
 MIKROE-2564

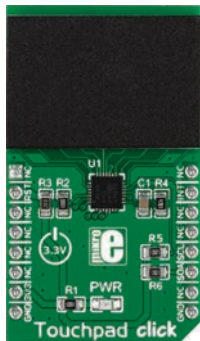

Touchpad Click

5V | 3.3V | SPI | I2C

UART | GPIO | PWM | AN

Capacitive touch input device driven by Microchip's MTCH6102 controller.

MSRP – \$15⁰⁰
MIKROE-1995



Thumbstick Click

5V | 3.3V | SPI | I2C

UART | GPIO | PWM | AN

A high precision input device with a dual axis, spring return and push-button enabled joystick.

MSRP – \$20⁰⁰
MIKROE-1627



Cap Extend 3 Click

5V | 3.3V | SPI | I2C

UART | GPIO | PWM | AN

With four capacitive sensor pads that can sense touch through a variety of different materials.

MSRP – \$16⁰⁰
MIKROE-2474



Cap Touch Click

5V | 3.3V | SPI | I2C

UART | GPIO | PWM | AN

A capacitive touch sensing button, integrated on a Click board™.

MSRP – \$16⁰⁰
MIKROE-2888

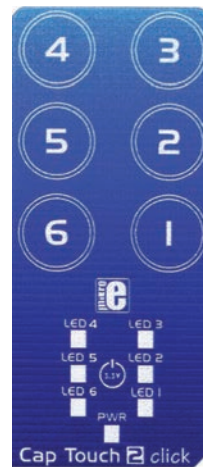

Cap Touch 2 Click

5V | 3.3V | SPI | I2C

UART | GPIO | PWM | AN

a capacitive touch sensing button, which features the CAP1166.

MSRP – \$15⁰⁰
MIKROE-2964

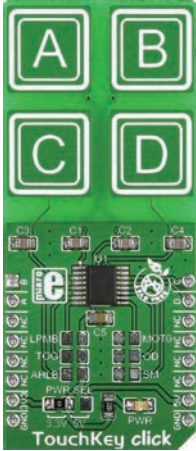

TouchKey Click

5V | 3.3V | SPI | I2C

UART | GPIO | PWM | AN

It has four capacitive pads powered by TTP224, a touch-pad detector IC.

MSRP – \$12⁰⁰
MIKROE-1906

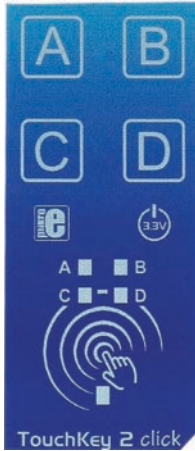

TouchKey 2 Click

5V | 3.3V | SPI | I2C

UART | GPIO | PWM | AN

With 4 capacitive pads powered by Microchip's ATtiny817. Integrated touch QTouch® controller.

MSRP – \$16⁰⁰
MIKROE-2474



TouchKey 3 Click

5V | 3.3V | SPI | I2C

UART | GPIO | PWM | AN

Equipped with advanced capacitive sensors, based on the proprietary QTouch® technology.

MSRP – \$19⁰⁰
MIKROE-2405



TouchKey 4 Click

5V | 3.3V | SPI | I2C

UART | GPIO | PWM | AN

A capacitive touch sensing button, with the advanced touch/proximity sensor IC.

MSRP – \$15⁰⁰
MIKROE-2965

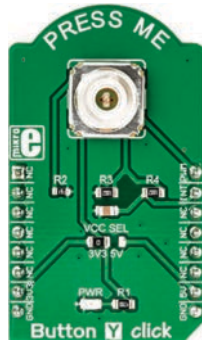

Button Y Click

5V | 3.3V | SPI | I2C
UART | GPIO | PWM | AN

Designed with the high-quality, single-pole, single-throw (SPST) tactile switch labeled as 3006.2111.

MSRP - \$9⁰⁰
MIKROE-3262



Button PLAY Click

5V | 3.3V | SPI | I2C
UART | GPIO | PWM | AN

It is equipped with the CTHS15CIC05ARROW, a capacitive touch sensor display.

MSRP - \$21⁰⁰
MIKROE-3327



Knob G Click

5V | 3.3V | SPI | I2C
UART | GPIO | PWM | AN

Combination of high-quality quadrature rotary encoder, and a LED ring of 24 individual green LEDs.

MSRP - \$17⁰⁰
MIKROE-3299

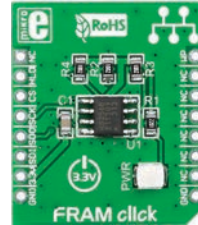

FRAM Click

5V | 3.3V | SPI | I2C
UART | GPIO | PWM | AN

256K [32,768 words x 8 bits] of Ferroelectric Random Access Memory with MB85RS256A module.

MSRP - \$15⁰⁰
MIKROE-1486

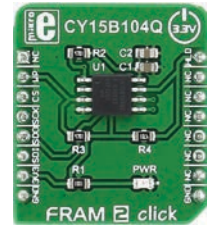

FRAM 2 Click

5V | 3.3V | SPI | I2C
UART | GPIO | PWM | AN

With CY15B104Q 4-Mbit [512K x 8] serial F-RAM from Cypress. 100 trillion [10¹⁴] read/writes.

MSRP - \$19⁰⁰
MIKROE-2768

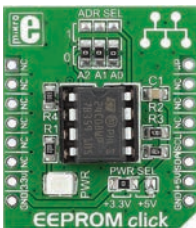

EEPROM Click

5V | 3.3V | SPI | I2C

UART | GPIO | PWM | AN

With 24C08WP - a highly reliable, high performance CMOS technology serial 8K EEPROM.

MSRP - \$8⁰⁰
MIKROE-1200



EEPROM 2 Click

5V | 3.3V | SPI | I2C

UART | GPIO | PWM | AN

With M95M02-DR DIP-8 socket EEPROM chip with 256 KB of memory from STMicroelectronics.

MSRP - \$18⁰⁰
MIKROE-1909



EEPROM 3 Click

5V | 3.3V | SPI | I2C

UART | GPIO | PWM | AN

With AT24CM02 DIP-8 socket EEPROM chip with 256 KB of memory from Microchip.

MSRP - \$14⁰⁰
MIKROE-1989

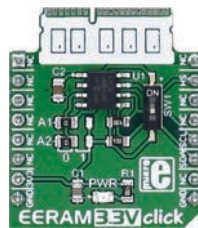

EERAM 3.3V Click

5V | 3.3V | SPI | I2C

UART | GPIO | PWM | AN

With 47L16 EERAM, a 16Kbit SRAM with EEPROM Backup from Microchip.

MSRP - \$14⁰⁰
MIKROE-2728

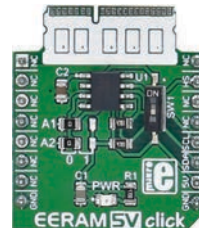

EERAM 5V Click

5V | 3.3V | SPI | I2C

UART | GPIO | PWM | AN

With 47C16 EERAM, a 16Kbit SRAM with EEPROM Backup from Microchip.

MSRP - \$14⁰⁰
MIKROE-2729

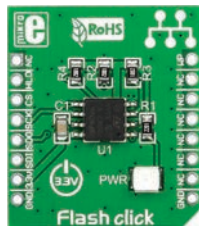

Flash Click

5V | 3.3V | SPI | I2C
 UART | GPIO | PWM | AN

With EN25Q80B - 8Mb serial Flash memory module. Clock frequency up to 75MHz.

MSRP - \$10⁰⁰
 MIKROE-1199

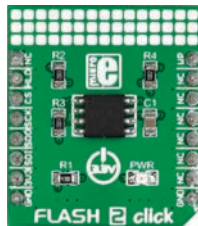

Flash 2 Click

5V | 3.3V | SPI | I2C
 UART | GPIO | PWM | AN

It carries Microchip's SST26VF064B flash-memory module with 64 Mbits capacity.

MSRP - \$12⁰⁰
 MIKROE-2267

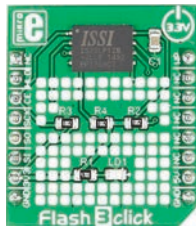

Flash 3 Click

5V | 3.3V | SPI | I2C
 UART | GPIO | PWM | AN

With ISSI's IS25LP128 IC with 128 Mbit capacity. 50MHz at Normal, 133MHz at Fast Read speeds.

MSRP - \$12⁰⁰
 MIKROE-2374



Flash 4 Click

5V | 3.3V | SPI | I2C
 UART | GPIO | PWM | AN

Carries the S25FL512S, a 512 Mbit SPI Flash memory module.

MSRP - \$25⁰⁰
 MIKROE-3191

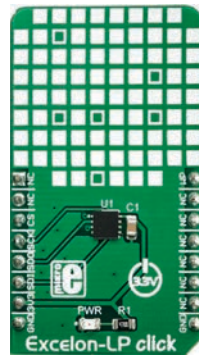

Excelon-LP Click

5V | 3.3V | SPI | I2C
 UART | GPIO | PWM | AN

Equipped with the CY15B108Q, a serial ferroelectric (FRAM) module with 8 Mbit density.

MSRP - \$25⁰⁰
 MIKROE-3104



MAC Address Click

5V 3.3V SPI I2C

UART GPIO PWM AN

A unique node address. Carries 24AA025E64 2Kb Serial EEPROM with EUI-64™ node identity.

MSRP – \$9⁰⁰
MIKROE-2733



microSD Click

5V 3.3V SPI I2C

UART GPIO PWM AN

With a microSD card slot for microSD cards used as a mass storage media for portable devices.

MSRP – \$16⁰⁰
MIKROE-924



Secure Click

5V 3.3V SPI I2C

UART GPIO PWM AN

With ATECC508A cryptographic coprocessor with secure hardware-based key storage.

MSRP – \$9⁰⁰
MIKROE-252

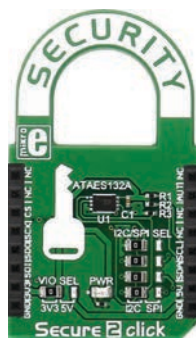

Secure 2 Click

5V 3.3V SPI I2C

UART GPIO PWM AN

Microchip's ATAES132A, a cryptographic coprocessor with secure hardware-based key storage.

MSRP – \$9⁰⁰
MIKROE-2760



Secure 3 Click

5V 3.3V SPI I2C

UART GPIO PWM AN

Microchip's ATSHA204A, a cryptographic coprocessor with secure hardware-based key storage.

MSRP – \$9⁰⁰
MIKROE-2761



Secure 4 Click

5V 3.3V SPI I2C

UART GPIO PWM AN

Includes the ATECC608A, a secure CryptoAuthentication™ device from Microchip.

MSRP – \$9⁰⁰
MIKROE-2829

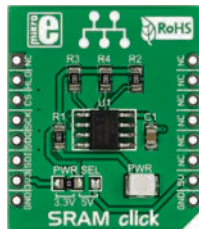

SRAM Click

5V 3.3V SPI I2C

UART GPIO PWM AN

Provides 1 Mbit of additional SRAM memory, via Microchip's 23LC1024.

MSRP – \$15⁰⁰
MIKROE-1902

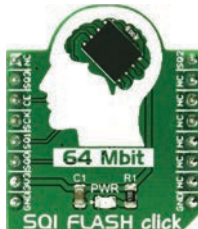

SQI FLASH Click

5V 3.3V SPI I2C

UART GPIO PWM AN

Based on the SST-26VF064B, a 64 Mbit Serial Quad I/O flash device from Microchip.

MSRP – \$13⁹⁰
MIKROE-2828

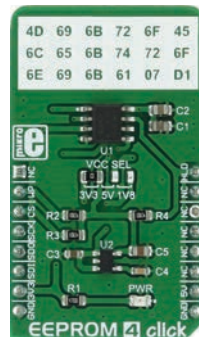

EEPROM 4 Click

5V 3.3V SPI I2C

UART GPIO PWM AN

An EEPROM memory medium with the capacity of 256KB.

MSRP – \$15⁰⁰
MIKROE-2536

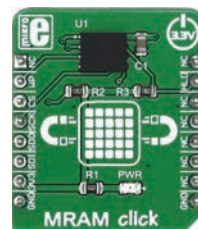

MRAM Click

5V 3.3V SPI I2C

UART GPIO PWM AN

Uses the MR25H256, a 256 kilobits serial SPI MRAM memory module from Everspin company.

MSRP – \$18⁰⁰
MIKROE-2914

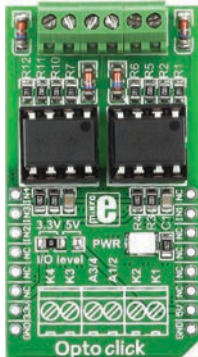

Opto Click

5V 3.3V SPI I2C
UART GPIO PWM AN

It features two V02630 dual channel, high speed optocoupler modules.

MSRP – \$21⁰⁰
MIKROE-1196



RELAY Click

5V 3.3V SPI I2C
UART GPIO PWM AN

With two G6D1AA-SI-5DC power PCB relay modules. Controls up to 5A, 250V AC/30V DC loads.

MSRP – \$18⁰⁰
MIKROE-1370

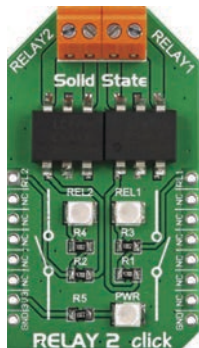

Relay 2 Click

5V 3.3V SPI I2C
UART GPIO PWM AN

Carries two LCA717 single-pole, OptoMOS® solid state relays.

MSRP – \$26⁰⁰
MIKROE-1899

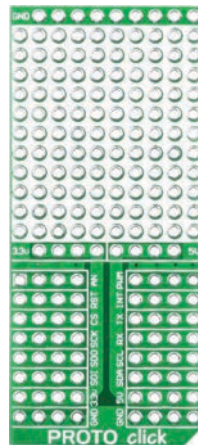

PROTO Click

5V 3.3V SPI I2C
UART GPIO PWM AN

10x11 prototyping area and additional power pads for creating custom electronics or Click boards™.

MSRP – \$4⁵⁰
MIKROE-1507



FLICKER Click

5V 3.3V SPI I2C
UART GPIO PWM AN

TI's NA556 dual precision timer and Omron's G6D-ASI power PCB relay. ON/OFF 0.1-6 sec.

MSRP – \$19⁰⁰
MIKROE-2481

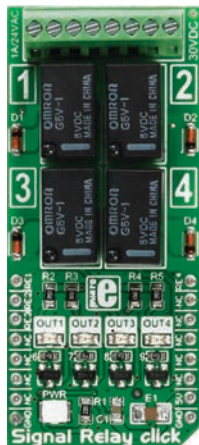

Signal Relay Click

5V 3.3V SPI I2C
UART GPIO PWM AN

It carries four ultra-small GV5-1 PCB relays from Omron. For ON/OFF control.

MSRP – \$29⁰⁰
MIKROE-2154

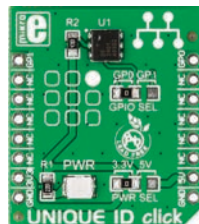

UNIQUE ID Click

5V 3.3V SPI I2C
UART GPIO PWM AN

With DS2401 enhanced silicon serial number IC. Provides a unique registration number.

MSRP – \$9⁰⁰
MIKROE-1819

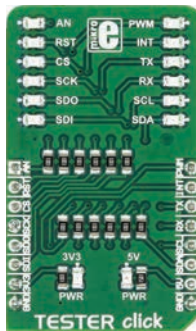

TESTER Click

5V 3.3V SPI I2C
UART GPIO PWM AN

An ideal solution for testing and diagnostics of the mikroBUS™ socket pin states.

MSRP – \$6⁰⁰
MIKROE-3083

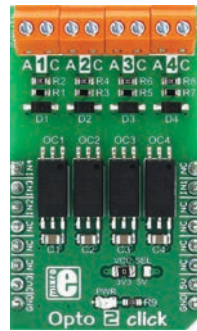

Opto 2 Click

5V 3.3V SPI I2C
UART GPIO PWM AN

Uses four TLP2770, 20-Mbps low-power optocouplers, from Toshiba.

MSRP – \$25⁰⁰
MIKROE-3015

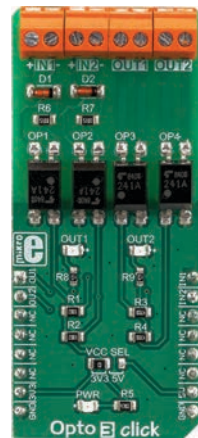

Opto 3 Click

5V 3.3V SPI I2C
UART GPIO PWM AN

Two pairs of normally opened, high-quality solid-state relays labeled as TLP241A.

MSRP – \$21⁰⁰
MIKROE-3319

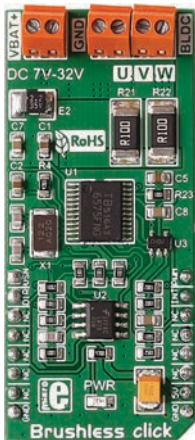

Brushless Click

5V | 3.3V | SPI | I2C

UART | GPIO | PWM | AN

Toshiba's TB6575F-NG IC for driving 3-phase full-wave Brushless DC motors.

MSRP - \$39⁰⁰
MIKROE-2441



Brushless 2 Click

5V | 3.3V | SPI | I2C

UART | GPIO | PWM | AN

It carries TI's DRV10964 BLDC motor controller with an integrated output stage.

MSRP - \$26⁰⁰
MIKROE-2754



Brushless 3 Click

5V | 3.3V | SPI | I2C

UART | GPIO | PWM | AN

With TI's DRV10983 three-phase sensorless motor driver with integrated power MOSFETs.

MSRP - \$19⁰⁰
MIKROE-2766

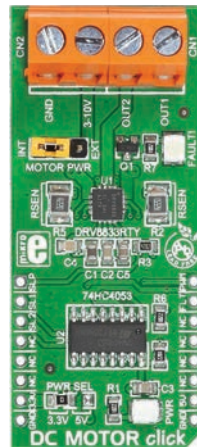

DC MOTOR Click

5V | 3.3V | SPI | I2C

UART | GPIO | PWM | AN

With TI's DRV8833RT-Bridge motor driver and TI's 74HC4053 multiplexer.

MSRP - \$18⁰⁰
MIKROE-1526



DC MOTOR 2 Click

5V | 3.3V | SPI | I2C

UART | GPIO | PWM | AN

With Toshiba's TB6593F-NG driver IC for direct current motors. Motors' supply voltage 2.5V-13V.

MSRP - \$17⁰⁰
MIKROE-2699



DC MOTOR 3 Click

5V 3.3V SPI I2C
UART GPIO PWM AN

With Toshiba's TB-6549FG full-bridge driver for direct current motors. Up to 3.5A with 30V.

MSRP – \$19⁰⁰
MIKROE-2047

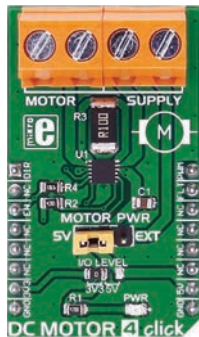

DC MOTOR 4 Click

5V 3.3V SPI I2C
UART GPIO PWM AN

With MAX14870 motor driver from Maxim Integrated. Motors' voltage supply 4.5V-36V.

MSRP – \$15⁰⁰
MIKROE-2221

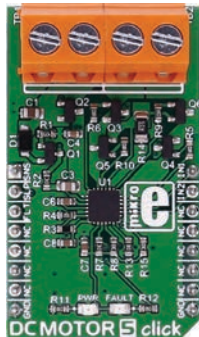

DC MOTOR 5 Click

5V 3.3V SPI I2C
UART GPIO PWM AN

With TI's DRV8701 brushed DC motor full-bridge gate driver. Operating voltage supply 5.9V-45V.

MSRP – \$17⁰⁰
MIKROE-2699

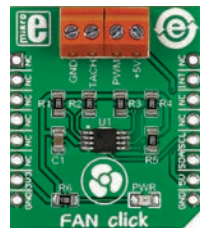

Fan Click

5V 3.3V SPI I2C
UART GPIO PWM AN

With EMC2301 controller for powering and regulating the operation of 5V four-wire fans.

MSRP – \$9⁰⁰
MIKROE-2004

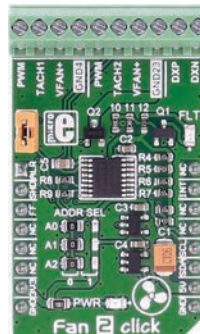

Fan 2 Click

5V 3.3V SPI I2C
UART GPIO PWM AN

With MAX31760 precision fan-speed controller. Can control two fans at the same time.

MSRP – \$15⁰⁰
MIKROE-2708

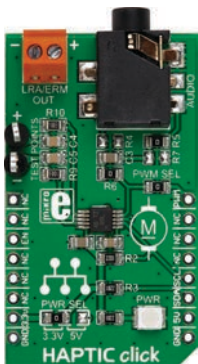

HAPTIC Click

5V | 3.3V | SPI | I2C

UART | GPIO | PWM | AN

With DRV2605 Haptic Driver for ERM and LRA vibration motors. Over 100 haptic effects library.

MSRP – \$23⁰⁰
MIKROE-2025



PWM driver Click

5V | 3.3V | SPI | I2C

UART | GPIO | PWM | AN

Silicon Labs' Si8711CC one-channel isolator for controlling DC motors with loads up to 10A.

MSRP – \$14⁰⁰
MIKROE-2272

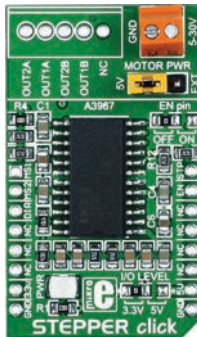

STEPPER Click

5V | 3.3V | SPI | I2C

UART | GPIO | PWM | AN

With A3967SLBT microstepping motor driver with a built-in translator. Max. output drive 30V, ±500 mA.

MSRP – \$18⁰⁰
MIKROE-1528

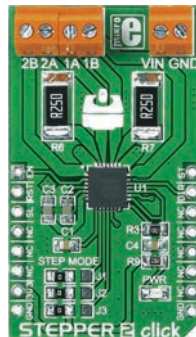

STEPPER 2 Click

5V | 3.3V | SPI | I2C

UART | GPIO | PWM | AN

With A4988 microstepping motor driver. Required external power supply minimum 7V.

MSRP – \$19⁰⁰
MIKROE-1926

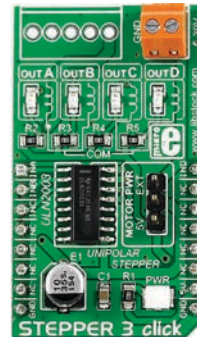

STEPPER 3 Click

5V | 3.3V | SPI | I2C

UART | GPIO | PWM | AN

With TI's ULN2003 High-Current Darlington transistor array. For precise motor control.

MSRP – \$19⁰⁰
MIKROE-2035

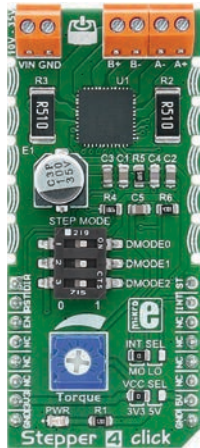

STEPPER 4 Click

5V | 3.3V | SPI | I2C

UART | GPIO | PWM | AN

With TB67S269FTG two-phase bipolar stepping motor driver from Toshiba.

MSRP – \$19⁰⁰
MIKROE-2748

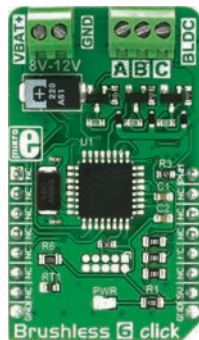

Brushless 6 Click

5V | 3.3V | SPI | I2C

UART | GPIO | PWM | AN

Designed to drive a three-phase sensorless, brushless motor. With ATmega8A from Microchip.

MSRP – \$27⁰⁰
MIKROE-2847

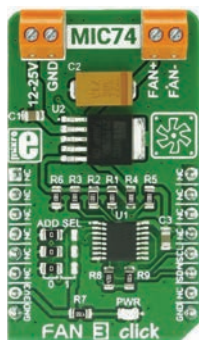

Fan 3 Click

5V | 3.3V | SPI | I2C

UART | GPIO | PWM | AN

Perfect solution for speed control. It can operate in seven discrete speed steps.

MSRP – \$17⁹⁰
MIKROE-2841



Vibro Motor Click

5V | 3.3V | SPI | I2C

UART | GPIO | PWM | AN

Features a compact size Eccentric Rotating Mass (ERM) motor, labeled as C1026B002F.

MSRP – \$12⁰⁰
MIKROE-2826

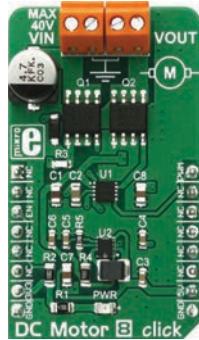

DC Motor 8 Click

5V | 3.3V | SPI | I2C

UART | GPIO | PWM | AN

The MIC4605, 85V half-bridge MOSFET driver with adaptive dead time and shoot-through protection.

MSRP – \$18⁰⁰
MIKROE-2893

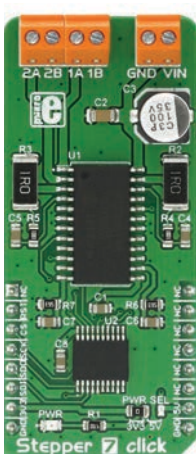

Stepper 7 Click

5V | 3.3V | SPI | I2C

UART | GPIO | PWM | AN

MTS62C19A Dual Full-Bridge Motor Driver, MCP23S08 8bit I/O Expander with Serial Interface.

MSRP – \$17⁰⁰
MIKROE-2912



H-Bridge Click

5V | 3.3V | SPI | I2C

UART | GPIO | PWM | AN

Uses the MC34933, a dual H-bridge driver, from NXP.

MSRP – \$16⁰⁰
MIKROE-3031

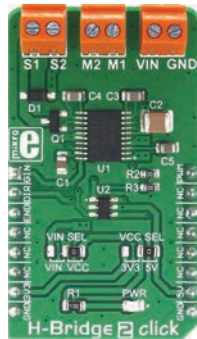

H-Bridge 2 Click

5V | 3.3V | SPI | I2C

UART | GPIO | PWM | AN

Uses the MPC17510, an H-Bridge DC motor driver, with up to 15V and 1.2A, from NXP.

MSRP – \$18⁰⁰
MIKROE-3000

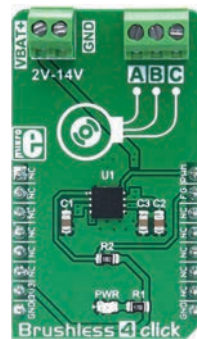

Brushless 4 Click

5V | 3.3V | SPI | I2C

UART | GPIO | PWM | AN

The MCP8063, a 3 phase brushless sinusoidal sensorless motor driver, from Microchip.

MSRP – \$19⁰⁰
MIKROE-3019

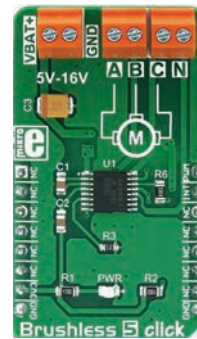

Brushless 5 Click

5V | 3.3V | SPI | I2C

UART | GPIO | PWM | AN

Uses the A4941, a three-phase sensorless fan driver IC, made by Allegro MicroSystems LLC.

MSRP – \$19⁰⁰
MIKROE-3032



Stepper 5 Click

5V | 3.3V | SPI | I2C
 UART | GPIO | PWM | AN

Uses the TM2208, a highly integrated bipolar step motor power driver, with the UART interface.

MSRP – \$17⁰⁰
 MIKROE-2624



Driver Click

5V | 3.3V | SPI | I2C
 UART | GPIO | PWM | AN

The DRV777, an integrated motor and relay driver from Texas Instruments.

MSRP – \$13⁰⁰
 MIKROE-3109

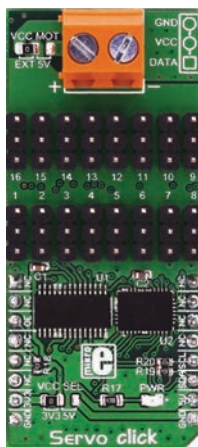

Servo Click

5V | 3.3V | SPI | I2C
 UART | GPIO | PWM | AN

A 16-channel PWM servo driver with the voltage sensing circuitry.

MSRP – \$25⁰⁰
 MIKROE-3133



FAN 4 Click

5V | 3.3V | SPI | I2C
 UART | GPIO | PWM | AN

A two-wire fan driver. Utilizes the LTC1695, an I2C fan speed controller.

MSRP – \$15⁰⁰
 MIKROE-3200

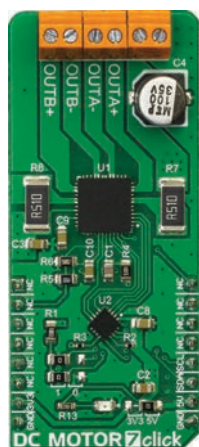

DC MOTOR 7 Click

5V | 3.3V | SPI | I2C
 UART | GPIO | PWM | AN

Advanced PWM chopper-type integrated DC motor driver, labeled as TB67H400AFTG.

MSRP – \$19⁰⁰
 MIKROE-3289

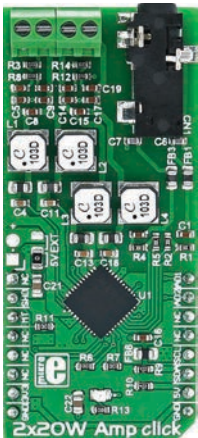

2x20W Amp Click

5V 3.3V SPI I2C

UART GPIO PWM AN

Carries MAX9744 stereo class D audio power amplifier from Maxim Integrated.

MSRP – \$21⁰⁰
MIKROE-2779



2x5W AMP Click

5V 3.3V SPI I2C

UART GPIO PWM AN

Functions as an amplifier. With TDA7491LP 2x5-watt dual BTL class-D audio amplifier.

MSRP – \$19⁰⁰
MIKROE-2477



AudioAmp Click

5V 3.3V SPI I2C

UART GPIO PWM AN

A mono audio amplifier. With TI's LM48100Q-Q1 Boomer™ Mono, 1.3W Audio Power Amplifier IC.

MSRP – \$14⁰⁰
MIKROE-2368



BUZZ Click

5V 3.3V SPI I2C

UART GPIO PWM AN

Features a piezo speaker capable of emitting audio signals. Resonant frequency 3.8 kHz.

MSRP – \$9⁰⁰
MIKROE-945

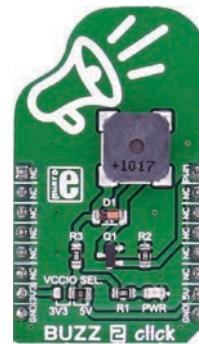

BUZZ 2 Click

5V 3.3V SPI I2C

UART GPIO PWM AN

With CMT-8540S-SMT magnetic buzzer transducer. The buzzer's resonant frequency is 4 kHz.

MSRP – \$12⁰⁰
MIKROE-2720



StereoAmp Click

5V | 3.3V | SPI | I2C

UART | GPIO | PWM | AN

With 2 TI's LM48100Q-Q1 Boomer™ single supply, mono, bridge-tied load amplifier ICs.

MSRP – \$24⁰⁰
MIKROE-2454

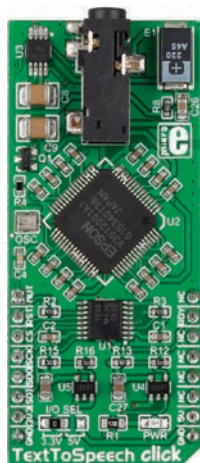

TextToSpeech Click

5V | 3.3V | SPI | I2C

UART | GPIO | PWM | AN

With S1V30120 speech synthesis IC powered by the Fonix DECTalk® v5 speech synthesis engine.

MSRP – \$39⁰⁰
MIKROE-2253

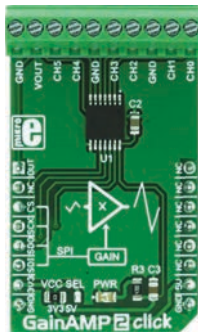

GainAMP 2 Click

5V | 3.3V | SPI | I2C

UART | GPIO | PWM | AN

A 6-channel programmable gain amplifier. Amplifies up to 32x, in eight discrete steps.

MSRP – \$15⁰⁰
MIKROE-2859



RadioStation Click

5V | 3.3V | SPI | I2C

UART | GPIO | PWM | AN

With the Si4713-B30, the best in class integrated FM broadcast stereo transmitter.

MSRP – \$25⁰⁰
MIKROE-2822

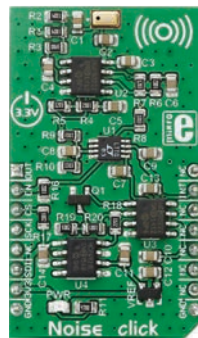

Noise Click

5V | 3.3V | SPI | I2C

UART | GPIO | PWM | AN

With noise detecting circuitry. Enables you to set a noise detection threshold.

MSRP – \$29⁰⁰
MIKROE-2371

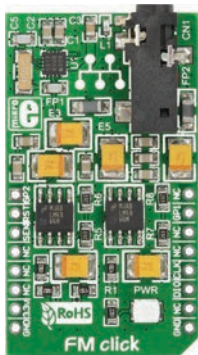

FM Click

5V | 3.3V | SPI | I2C
 UART | GPIO | PWM | AN

Features Si4703 IC and functions as a FM radio tuner. Supports worldwide FM band [76–108 MHz].

MSRP – \$29⁰⁰
 MIKROE-1431

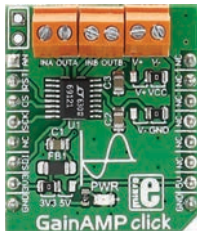

GainAMP Click

5V | 3.3V | SPI | I2C
 UART | GPIO | PWM | AN

Carries LTC®6912 dual channel, low noise, digitally programmable gain amplifier (PGA).

MSRP – \$15⁰⁰
 MIKROE-2555

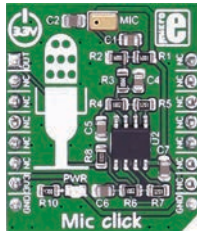

Mic Click

5V | 3.3V | SPI | I2C
 UART | GPIO | PWM | AN

With SPQ410HR5H-B surface mount silicon microphone with max. RF protection.

MSRP – \$9⁰⁰
 MIKROE-2563

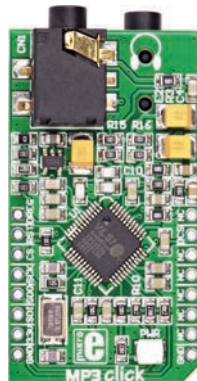

MP3 Click

5V | 3.3V | SPI | I2C
 UART | GPIO | PWM | AN

With a stereo MP3 decoder VS1053. Multiple formats [MP3, MP1, MP2, MPEG4, etc.].

MSRP – \$21⁹⁰
 MIKROE-946



2x30W Amp Click

5V | 3.3V | SPI | I2C
 UART | GPIO | PWM | AN

The TPA3128, 2x30-W class-D amplifier with low idle power dissipation, from TI.

MSRP – \$23⁰⁰
 MIKROE-3010



AudioAmp 2 Click

5V 3.3V SPI I2C
 UART GPIO PWM AN

The TDA7491, a 20W dual BTL class-D audio amplifier IC, from STMicroelectronics.

MSRP – \$21⁰⁰
 MIKROE-3077

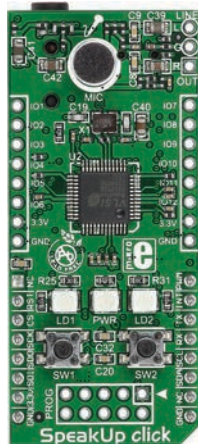

SpeakUp Click

5V 3.3V SPI I2C
 UART GPIO PWM AN

A speech recognition Click. Can recognize over 200 different voice commands.

MSRP – \$39⁰⁰
 MIKROE-1534

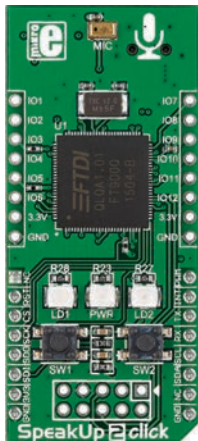

SpeakUp 2 Click

5V 3.3V SPI I2C
 UART GPIO PWM AN

A speech recognition Click. Set it up to recognize up to 100 commands.

MSRP – \$34⁰⁰
 MIKROE-2375

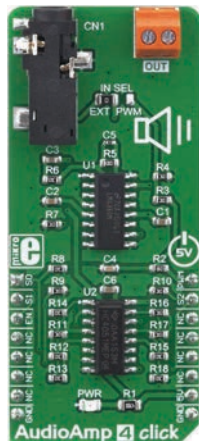

AudioAmp 4 Click

5V 3.3V SPI I2C
 UART GPIO PWM AN

With the LM4860, an audio amplifier IC capable of delivering up to 1W of continuous power to an 8Ω load.

MSRP – \$17⁰⁰
 MIKROE-3271

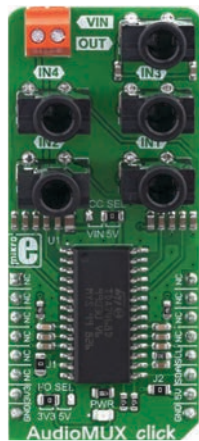

AudioMUX Click

5V 3.3V SPI I2C
 UART GPIO PWM AN

Two-band digitally controlled high-quality audio processor with BASS ALC feat. and a 4-channel input selector.

MSRP – \$49⁰⁰
 MIKROE-3344

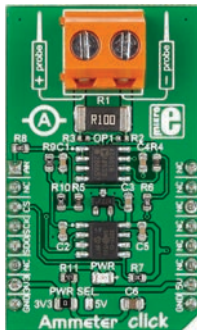

Ammeter Click

5V 3.3V SPI I2C
 UART GPIO PWM AN

With circuitry for measuring electric current (AC and DC). 0.1A-1A measurement range.

MSRP - \$24⁰⁰
 MIKROE-2377

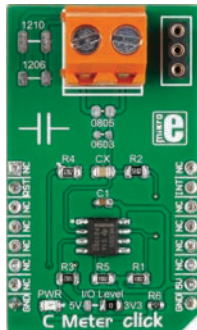

C Meter Click

5V 3.3V SPI I2C
 UART GPIO PWM AN

Circuitry for measuring the value of capacitors. Based on NE-555 timer/square-wave generator.

MSRP - \$9⁰⁰
 MIKROE-2376

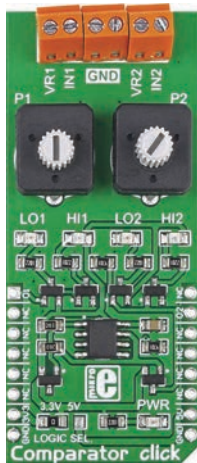

Comparator Click

5V 3.3V SPI I2C
 UART GPIO PWM AN

Carries LM2903 IC, has two independent precision voltage comparators. 2 mV offset voltage.

MSRP - \$12⁰⁰
 MIKROE-1915

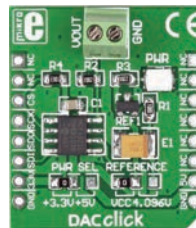

DAC Click

5V 3.3V SPI I2C
 UART GPIO PWM AN

Includes a 12-bit Digital-to-Analog Converter MCP4921 from Microchip.

MSRP - \$18⁰⁰
 MIKROE-950

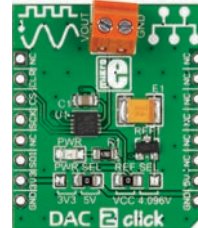

DAC 2 Click

5V 3.3V SPI I2C
 UART GPIO PWM AN

Carries LTC2601CDD, a 16-bit digital-to-analog converter from Linear Technology.

MSRP - \$19⁰⁰
 MIKROE-1918

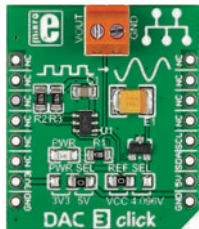

DAC 3 Click

5V 3.3V SPI I2C
 UART GPIO PWM AN

Carries Microchip's MCP4726 IC, a 12-bit digital-to-analog converter.

MSRP – \$18⁰⁰
 MIKROE-2038

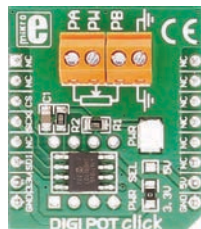

DIGI POT Click

5V 3.3V SPI I2C
 UART GPIO PWM AN

Carries MCP416 single-channel 8-bit resolution [256 wiper steps] digital potentiometer.

MSRP – \$16⁹⁰
 MIKROE-923

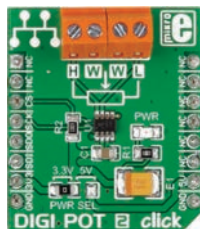

DIGI POT 2 Click

5V 3.3V SPI I2C
 UART GPIO PWM AN

Carries a single channel digital potentiometer TPL0501 with 256 wiper positions.

MSRP – \$16⁹⁰
 MIKROE-2332

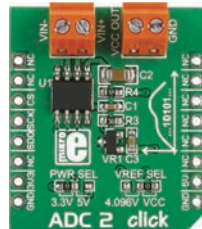

ADC 2 Click

5V 3.3V SPI I2C
 UART GPIO PWM AN

With MCP3551/3, a 22-bit ADC with automatic internal offset and gain calibration.

MSRP – \$24⁰⁰
 MIKROE-1893

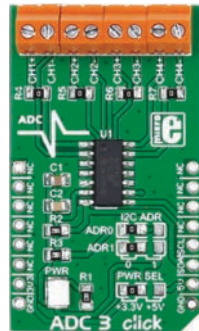

ADC 3 Click

5V 3.3V SPI I2C
 UART GPIO PWM AN

With Microchip's MCP3428 16-bit multichannel analog-to-digital converter.

MSRP – \$22⁰⁰
 MIKROE-1894



R Meter Click

5V 3.3V SPI I2C

UART GPIO PWM AN

With circuitry for measuring the value of resistors. A wide range of resistors [0-1 Mega Ohm].

MSRP – \$27⁰⁰
MIKROE-2396

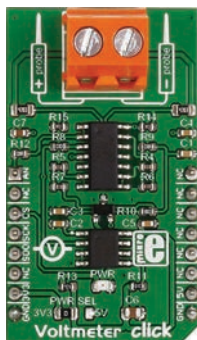

Voltmeter Click

5V 3.3V SPI I2C

UART GPIO PWM AN

For measuring voltage in an external electric circuit. Measures direct current [from 0 to 24V].

MSRP – \$24⁰⁰
MIKROE-2436



ADC 4 Click

5V 3.3V SPI I2C

UART GPIO PWM AN

An advanced analog to digital multichannel converter. It can work in 16bit or 24bit mode.

MSRP – \$65⁰⁰
MIKROE-2879

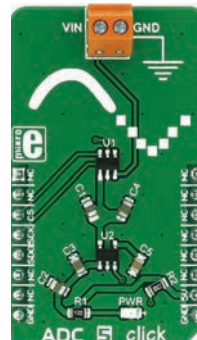

ADC 5 Click

5V 3.3V SPI I2C

UART GPIO PWM AN

With a low power, single channel 12-bit CMOS analog to digital converter.

MSRP – \$18⁰⁰
MIKROE-2846

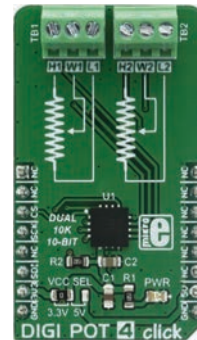

DIGI POT 4 Click

5V 3.3V SPI I2C

UART GPIO PWM AN

A digitally controlled dual potentiometer, with the resistance of 10KΩ.

MSRP – \$21⁰⁰
MIKROE-2873

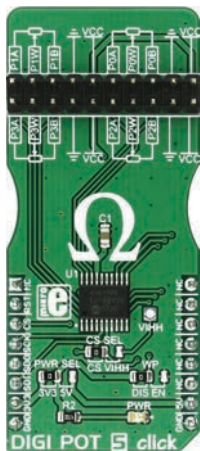

DIGI POT 5 Click

5V 3.3V SPI I2C
UART GPIO PWM AN

A digitally controlled quad potentiometer, with the resistance of 10K Ω .

MSRP – \$16⁹⁰
MIKROE-2863

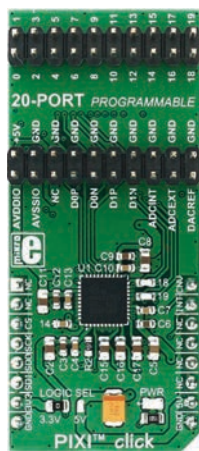

PIXI™ Click

5V 3.3V SPI I2C
UART GPIO PWM AN

Features proprietary PIXI™ technology. Configurable 20-channel mixed-signal data converter.

MSRP – \$29⁰⁰
MIKROE-2817



Slider Click

5V 3.3V SPI I2C
UART GPIO PWM AN

Features a mechanical slide action potentiometer.

MSRP – \$24⁰⁰
MIKROE-2702



LEM Click

5V 3.3V SPI I2C
UART GPIO PWM AN

Measures AC and DC current (up to 200 KHz). With LTS 6-NP current transducer.

MSRP – \$59⁰⁰
MIKROE-2553

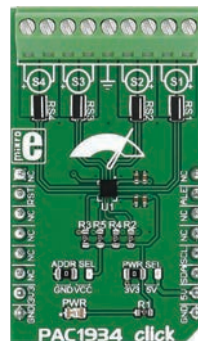

PAC1934 Click

5V 3.3V SPI I2C
UART GPIO PWM AN

Carries PAC1934 four channel DC power/energy monitor from Microchip.

MSRP – \$29⁰⁰
MIKROE-2735

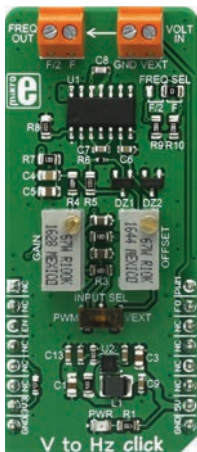

V to Hz Click

5V | 3.3V | SPI | I2C
 UART | GPIO | PWM | AN

The TC9400, a voltage-to-frequency and frequency-to-voltage converter from Microchip.

MSRP - \$27⁰⁰
 MIKROE-2889

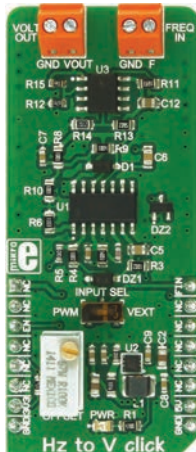

Hz to V Click

5V | 3.3V | SPI | I2C
 UART | GPIO | PWM | AN

The TC9400, a voltage-to-frequency and frequency-to-voltage converter from Microchip.

MSRP - \$27⁰⁰
 MIKROE-2890

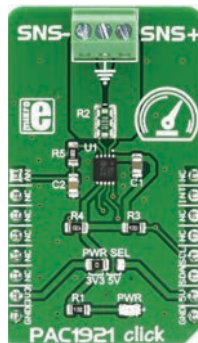

PAC1921 Click

5V | 3.3V | SPI | I2C
 UART | GPIO | PWM | AN

The PAC1921, a high side power/current monitor from Microchip.

MSRP - \$17⁰⁰
 MIKROE-2910

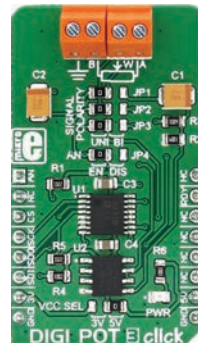

DIGI POT 3 Click

5V | 3.3V | SPI | I2C
 UART | GPIO | PWM | AN

The AD5321, a 1024-position [10bit] digital potentiometer with a non-volatile memory [EEMEM].

MSRP - \$21⁰⁰
 MIKROE-3016

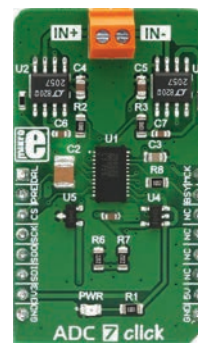

ADC 7 Click

5V | 3.3V | SPI | I2C
 UART | GPIO | PWM | AN

The LTC2500-32. It is a 32-bit oversampling ADC with a configurable digital filter, from Analog Devices.

MSRP - \$99⁰⁰
 MIKROE-3115



Multimeter Click

5V 3.3V SPI I2C
UART GPIO PWM AN

Has different ICs: amplifiers, NE555 timer, BCD decoder, frequency to voltage converter, and an A/D converter [ADC].

MSRP – \$39⁰⁰
MIKROE-3116

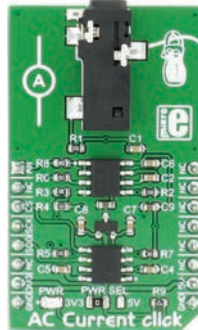

AC Current Click

5V 3.3V SPI I2C
UART GPIO PWM AN

Measure alternating currents up to 30A. MCP3201 ADC converter and MCP607 CMOS Op Amp.

MSRP – \$14⁰⁰
MIKROE-2523

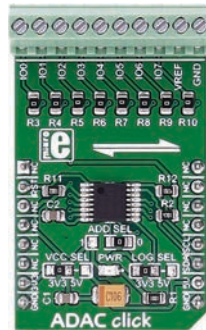

ADAC Click

5V 3.3V SPI I2C
UART GPIO PWM AN

It's an 8-channel 12-bit ADC, DAC and GPIO. With AD593R configurable ADC/DAC.

MSRP – \$26⁰⁰
MIKROE-2690

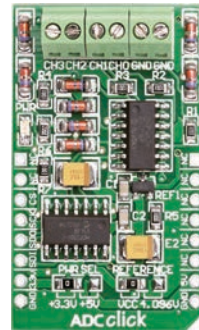

ADC Click

5V 3.3V SPI I2C
UART GPIO PWM AN

With Microchip's MCP3204 12-bit Analog-to-Digital converter.

MSRP – \$24⁰⁰
MIKROE-922

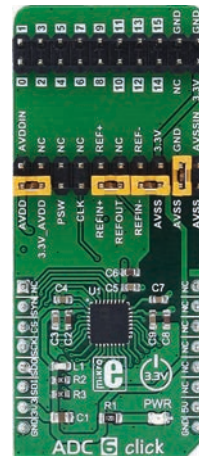

ADC 6 Click

5V 3.3V SPI I2C
UART GPIO PWM AN

With the AD7124-8, an 8 channel, low noise, low power, 24bit sigma-delta ADC.

MSRP – \$29⁰⁰
MIKROE-2932



Hz to V 2 Click

5V | 3.3V | SPI | I2C
UART | GPIO | PWM | AN

With the VFC32KU, a voltage-to-frequency and frequency-to-voltage converter.

MSRP – \$42⁰⁰
MIKROE-3126



V to Hz 2 Click

5V | 3.3V | SPI | I2C
UART | GPIO | PWM | AN

With the VFC32KU, a voltage-to-frequency and frequency-to-voltage converter.

MSRP – \$42⁰⁰
MIKROE-3131



PWR Meter Click

5V | 3.3V | SPI | I2C
UART | GPIO | PWM | AN

Uses the MCP39F511A, a very sophisticated monitoring IC from Microchip, with 16-bit processing core.

MSRP – \$42⁰⁰
MIKROE-3169

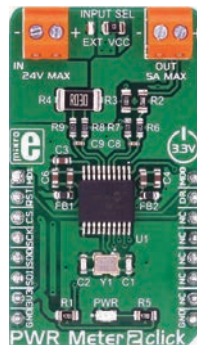

PWR Meter 2 Click

5V | 3.3V | SPI | I2C
UART | GPIO | PWM | AN

Measuring and monitoring voltage up to 24V and current up to 5A. It carries the MCP3910 module.

MSRP – \$19⁰⁰
MIKROE-3150

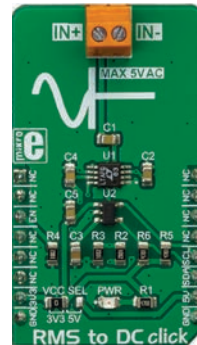

RMS to DC Click

5V | 3.3V | SPI | I2C
UART | GPIO | PWM | AN

With the LTC1968, converter IC, which outputs an analog voltage depending on the RMS value of the input signal.

MSRP – \$35⁰⁰
MIKROE-3311

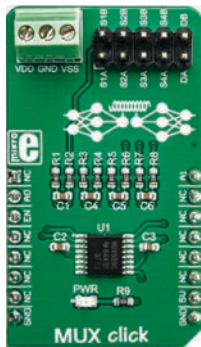

MUX Click

5V | 3.3V | SPI | I2C
 UART | GPIO | PWM | AN

Equipped with the MUX509, a precise analog multiplexing IC.

MSRP - \$17⁰⁰
 MIKROE-3247

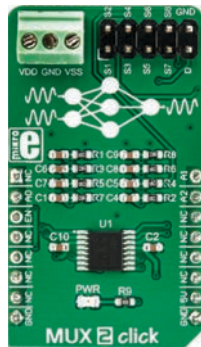

MUX 2 Click

5V | 3.3V | SPI | I2C
 UART | GPIO | PWM | AN

The MUX508, a modern CMOS analog multiplexing integrated circuit.

MSRP - \$17⁰⁰
 MIKROE-3245



Slider 2 Click

5V | 3.3V | SPI | I2C
 UART | GPIO | PWM | AN

Utilizes the PTA3043, a linear, high-grade, 10K potentiometer

MSRP - \$20⁰⁰
 MIKROE-3301

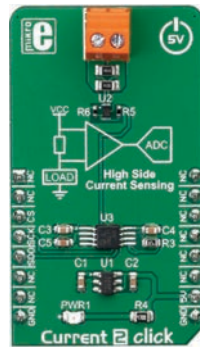

Current 2 Click

5V | 3.3V | SPI | I2C
 UART | GPIO | PWM | AN

Equipped with an integrated transimpedance amplifying circuit.

MSRP - \$17⁰⁰
 MIKROE-3292

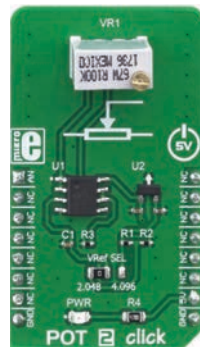

POT 2 Click

5V | 3.3V | SPI | I2C
 UART | GPIO | PWM | AN

The MCP1541, a precision voltage reference IC from Microchip is used to provide the voltage of 4.096V.

MSRP - \$12⁰⁰
 MIKROE-3325



Buck-Boost Click

5V | 3.3V | SPI | I2C
 UART | GPIO | PWM | AN

Features LTC3129-1, a buck-boost DC/DC conversion integrated circuit.

MSRP – \$20⁰⁰
 MIKROE-2806

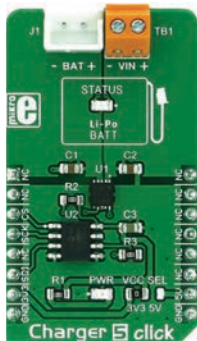

Charger 5 Click

5V | 3.3V | SPI | I2C
 UART | GPIO | PWM | AN

Designed to charge Lithium-Ion and Lithium-Polymer batteries.

MSRP – \$16⁰⁰
 MIKROE-2848

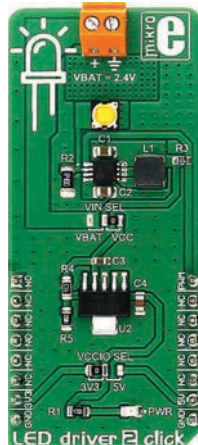

LED driver 2 Click

5V | 3.3V | SPI | I2C
 UART | GPIO | PWM | AN

Carries the MCP1643 - LED constant current regulator, made by Microchip.

MSRP – \$15⁰⁰
 MIKROE-2807

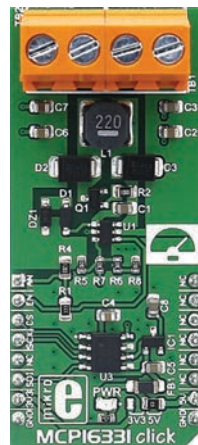

MCP16331 Click

5V | 3.3V | SPI | I2C
 UART | GPIO | PWM | AN

Functions as a non-inverting buck-boost voltage regulator.

MSRP – \$22⁰⁰
 MIKROE-2762

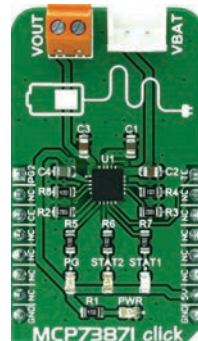

MCP73871 Click

5V | 3.3V | SPI | I2C
 UART | GPIO | PWM | AN

Integrated solution for system power delivery and Li-Po/Li-Ion battery charge management.

MSRP – \$16⁰⁰
 MIKROE-2858

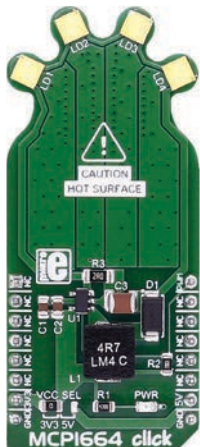

MCP1664 Click

5V | 3.3V | SPI | I2C

UART | GPIO | PWM | AN

With 4 high-power white LEDs. Carries Microchip's MCP1664, a high-voltage step-up LED driver.

MSRP – \$26⁰⁰
MIKROE-2548

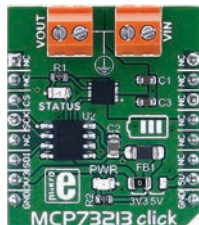

MCP73213 Click

5V | 3.3V | SPI | I2C

UART | GPIO | PWM | AN

Carries MCP73213 dual-cell Li-Ion/Li-Polymer battery charge management controller.

MSRP – \$18⁰⁰
MIKROE-2574



MIC23099 Click

5V | 3.3V | SPI | I2C

UART | GPIO | PWM | AN

Carries MIC23099 single AA/AAA cell step-down/step-up regulator with battery monitoring.

MSRP – \$29⁰⁰
MIKROE-2765



MIC24045 Click

5V | 3.3V | SPI | I2C

UART | GPIO | PWM | AN

Carries MIC24045 5A synchronous step-down regulator. Input range 4.5V-19V.

MSRP – \$13⁰⁰
MIKROE-2574



VREG Click

5V | 3.3V | SPI | I2C

UART | GPIO | PWM | AN

Digitally controlled DC voltage regulator. Based on the well-known LM317 circuit.

MSRP – \$24⁰⁰
MIKROE-2443

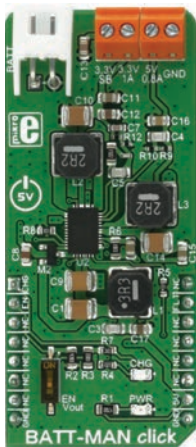

BATT-MAN Click

5V | 3.3V | SPI | I2C

UART | GPIO | PWM | AN

The LTC3586, a high-efficiency power manager with boost, buck-boost, and dual buck converters.

MSRP – \$27⁰⁰
MIKROE-2901

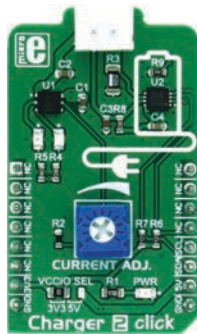

Charger 2 Click

5V | 3.3V | SPI | I2C

UART | GPIO | PWM | AN

The STBC08, an 800 mA standalone linear Li-Ion battery charger with thermal regulation.

MSRP – \$17⁰⁰
MIKROE-3049

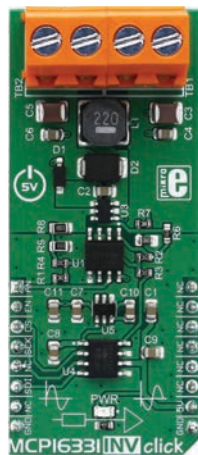

MCP16331 INV Click

5V | 3.3V | SPI | I2C

UART | GPIO | PWM | AN

Works in an inverting configuration, provides a negative output voltage in respect to the GND.

MSRP – \$22⁰⁰
MIKROE-2917

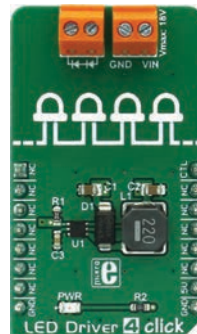

LED Driver 4 Click

5V | 3.3V | SPI | I2C

UART | GPIO | PWM | AN

The TPS61160A, a white LED driver with PWM brightness control.

MSRP – \$15⁰⁰
MIKROE-3037

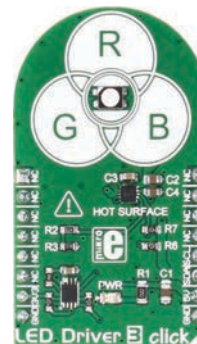

LED Driver 3 Click

5V | 3.3V | SPI | I2C

UART | GPIO | PWM | AN

The NCP5623B, a triple output RGB LED driver, controlled through the I2C protocol.

MSRP – \$15⁰⁰
MIKROE-2950

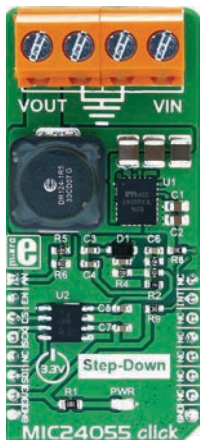

MIC24055 Click

5V | 3.3V | SPI | I2C
 UART | GPIO | PWM | AN

Equipped with the MIC24055, high-efficiency buck regulator from Microchip.

MSRP – \$29⁰⁰
 MIKROE-2835

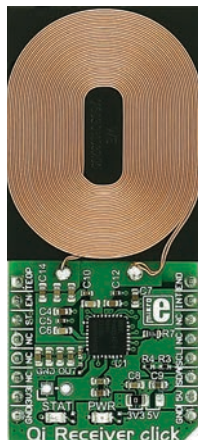

Qi Receiver Click

5V | 3.3V | SPI | I2C
 UART | GPIO | PWM | AN

Utilizes the principles of the inductive coupling for the purpose of wireless power transfer.

MSRP – \$18⁰⁰
 MIKROE-2799

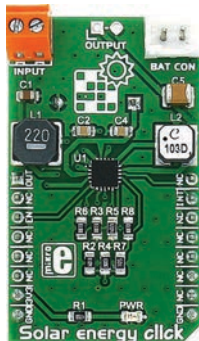

Solar energy Click

5V | 3.3V | SPI | I2C
 UART | GPIO | PWM | AN

Uses TI's BQ25570 - a nano-power high-efficiency boost charger and buck converter device.

MSRP – \$27⁰⁰
 MIKROE-2814

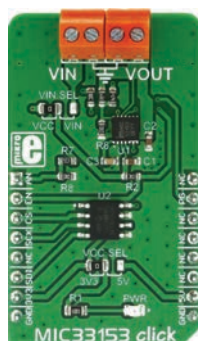

MIC33153 Click

5V | 3.3V | SPI | I2C
 UART | GPIO | PWM | AN

A DC-DC adjustable step-down (buck) converter.

MSRP – \$21⁰⁰
 MIKROE-2887



VREG 2 Click

5V | 3.3V | SPI | I2C
 UART | GPIO | PWM | AN

Uses the LM2596, a 3A, step down voltage regulator working at 150 kHz, from Texas Instruments.

MSRP – \$21⁰⁰
 MIKROE-3055



Buck-Boost 2 Click

5V | 3.3V | SPI | I2C
 UART | GPIO | PWM | AN

The LTC3115-2, a 40V, 2A synchronous buck-boost DC/DC converter from Linear Technology.

MSRP – \$27⁰⁰
 MIKROE-2963

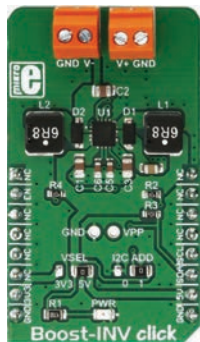

Boost-INV Click

5V | 3.3V | SPI | I2C
 UART | GPIO | PWM | AN

The LTC3582, programmable boost and inverting DC/DC converter with OTP memory.

MSRP – \$21⁰⁰
 MIKROE-3124

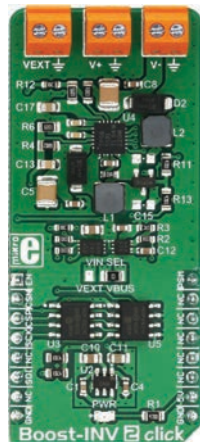

Boost-INV 2 Click

5V | 3.3V | SPI | I2C
 UART | GPIO | PWM | AN

The TPS65131, a positive and negative output DC/DC Converter, from Texas Instruments.

MSRP – \$29⁰⁰
 MIKROE-3123

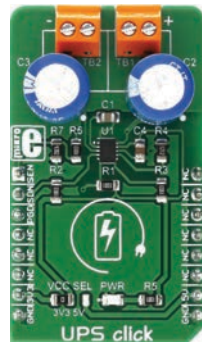

UPS Click

5V | 3.3V | SPI | I2C
 UART | GPIO | PWM | AN

The LTC3225, a 150mA supercapacitor charger from Linear Technology.

MSRP – \$25⁰⁰
 MIKROE-3001

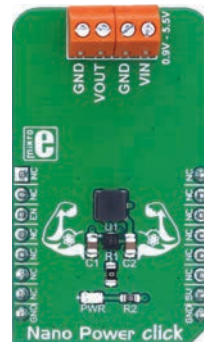

Nano Power Click

5V | 3.3V | SPI | I2C
 UART | GPIO | PWM | AN

The MAX17222 - a nanoPower synchronous boost converter with True Shutdown™ technology.

MSRP – \$11⁰⁰
 MIKROE-3035

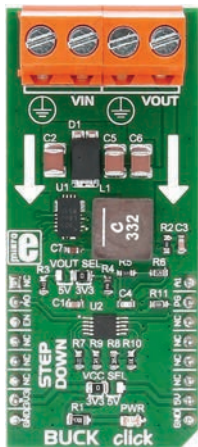

BUCK Click

5V | 3.3V | SPI | I2C
 UART | GPIO | PWM | AN

Buck switching regulator. A wide input voltage range of up to 40V. Steps it down to 3.3V or 5V.

MSRP – \$28⁰⁰
 MIKROE-1592

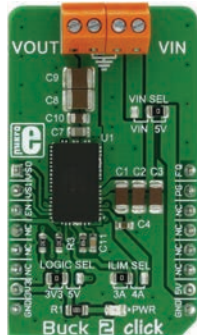

Buck 2 Click

5V | 3.3V | SPI | I2C
 UART | GPIO | PWM | AN

A powerful step down DC-DC switching regulator. Input voltage range 4.5V-19V.

MSRP – \$16⁰⁰
 MIKROE-2858



Buck 3 Click

5V | 3.3V | SPI | I2C
 UART | GPIO | PWM | AN

Uses the TPS568215, a 4.5V to 17V Input, 8A synchronous step-down SWIFT™ converter.

MSRP – \$22⁰⁰
 MIKROE-2971



BUCK 5 Click

5V | 3.3V | SPI | I2C
 UART | GPIO | PWM | AN

The MAX17506, a high efficiency, synchronous step-down DC/DC converter with internal compensation.

MSRP – \$29⁰⁰
 MIKROE-3100

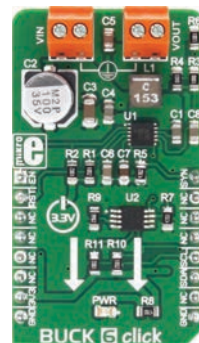

BUCK 6 Click

5V | 3.3V | SPI | I2C
 UART | GPIO | PWM | AN

Uses the MAX17572, a step down [buck] DC-DC converter from Maxim Integrated.

MSRP – \$18⁰⁰
 MIKROE-2957



Boost Click

5V | 3.3V | SPI | I2C
 UART | GPIO | PWM | AN

Carries Microchip's MIC2606, a 2MHz, PWM DC/DC boost switching regulator.

MSRP – \$21⁰⁰
 MIKROE-2780

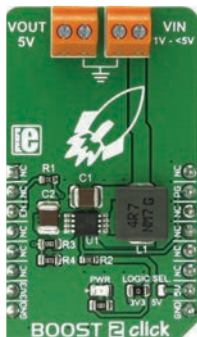

BOOST 2 Click

5V | 3.3V | SPI | I2C
 UART | GPIO | PWM | AN

A DC-DC step-up regulator that has a fixed 5V output.

MSRP – \$15⁰⁰
 MIKROE-2894



Boost 4 Click

5V | 3.3V | SPI | I2C
 UART | GPIO | PWM | AN

Carries TI's TPS61230A, a high efficiency fully integrated synchronous boost converter.

MSRP – \$17⁰⁰
 MIKROE-2757

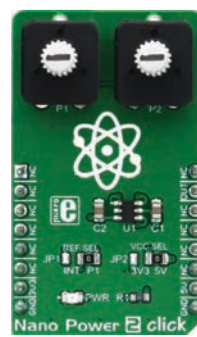

Nano Power 2 Click

5V | 3.3V | SPI | I2C
 UART | GPIO | PWM | AN

The MAX40000AUT12+, a nanoPower comparator with built-in reference.

MSRP – \$11⁰⁰
 MIKROE-3036

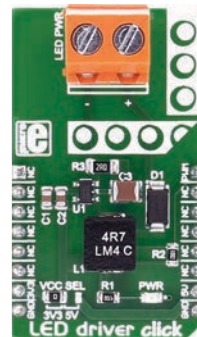

LED driver Click

5V | 3.3V | SPI | I2C
 UART | GPIO | PWM | AN

Carries MCP1662 high-voltage step-up voltage driver from Microchip.

MSRP – \$15⁰⁰
 MIKROE-2676



BUCK 7 Click

5V | 3.3V | SPI | I2C
 UART | GPIO | PWM | AN

The MAX17504, a high efficiency, synchronous step-down DC-DC converter with internal compensation.

MSRP – \$27⁰⁰
 MIKROE-3094



Buck 8 Click

5V | 3.3V | SPI | I2C
 UART | GPIO | PWM | AN

Uses the MAX17536, a high-efficiency, synchronous step-down DC-DC converter.

MSRP – \$26⁰⁰
 MIKROE-2997



Charger Click

5V | 3.3V | SPI | I2C
 UART | GPIO | PWM | AN

Carries a battery charger controller and a battery charge monitor, along with a battery connector.

MSRP – \$22⁰⁰
 MIKROE-2033

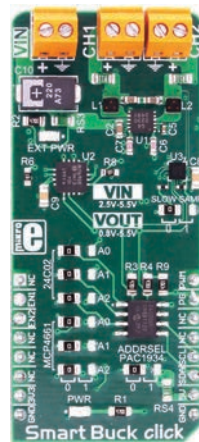

Smart Buck Click

5V | 3.3V | SPI | I2C
 UART | GPIO | PWM | AN

The MIC2230, a dual synchronous step-down DC/DC regulator.

MSRP – \$29⁰⁰
 MIKROE-3113

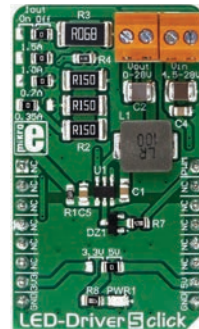

LED-Driver 5 Click

5V | 3.3V | SPI | I2C
 UART | GPIO | PWM | AN

The TPS54200, a synchronous buck converter designed to drive monochrome, color, and IR LED arrays.

MSRP – \$15⁰⁰
 MIKROE-3297



Buck-Boost 3 Click

5V | 3.3V | SPI | I2C
 UART | GPIO | PWM | AN

The ISL85403, a 2.5A regulator with the integrated high-side MOSFET and a low-side driver.

MSRP – \$27⁰⁰
 MIKROE-3277

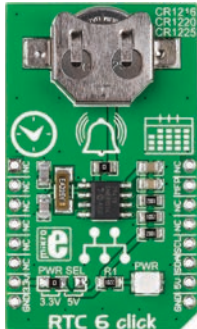

RTC 6 Click

5V | 3.3V | SPI | I2C
 UART | GPIO | PWM | AN

Carries MCP79410 real-time clock/calendar IC. 64 bytes of battery-backed SRAM.

MSRP – \$21⁰⁰
 MIKROE-2063

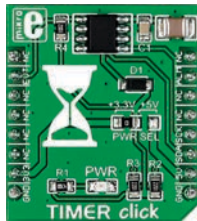

TIMER Click

5V | 3.3V | SPI | I2C
 UART | GPIO | PWM | AN

With DS1682 total elapsed time recorder from Maxim Integrated. ETC used with the ALARM pin.

MSRP – \$18⁰⁰
 MIKROE-2333

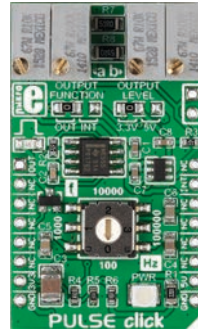

PULSE Click

5V | 3.3V | SPI | I2C
 UART | GPIO | PWM | AN

A pulse generator with precise frequency control. Features NE555 precision timer.

MSRP – \$25⁰⁰
 MIKROE-2032



RTC 2 Click

5V | 3.3V | SPI | I2C
 UART | GPIO | PWM | AN

With DS1307 serial real-time clock. It's a full binary-coded decimal [BCD] clock/calendar.

MSRP – \$21⁰⁰
 MIKROE-948

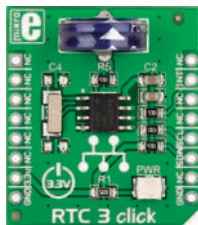

RTC 3 Click

5V | 3.3V | SPI | I2C
 UART | GPIO | PWM | AN

Carries BQ32000, a real time clock with an integrated trickle charge circuit for automatic switchover.

MSRP – \$21⁰⁰
 MIKROE-1839



RTC 4 Click

5V | 3.3V | SPI | I2C
 UART | GPIO | PWM | AN

Carries DS2417, a real time clock/calendar with a 1-Wire MicroLAN interface. 16.3 kbits per second.

MSRP – \$21⁰⁰
 MIKROE-1891

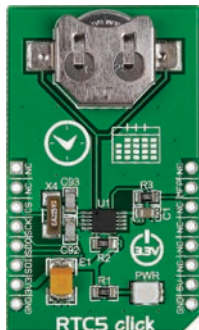

RTC 5 Click

5V | 3.3V | SPI | I2C
 UART | GPIO | PWM | AN

Carries Microchip's MCP79510 real-time clock/calendar.

MSRP – \$21⁰⁰
 MIKROE-1990



PLL Click

5V | 3.3V | SPI | I2C
 UART | GPIO | PWM | AN

The ICS501, a LOCO™ PLL clock multiplier, from Integrated Device Technology.

MSRP – \$15⁰⁰
 MIKROE-2993

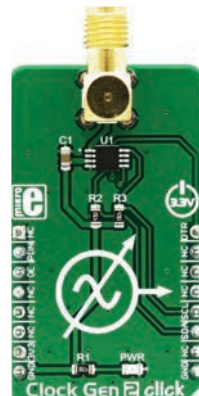

Clock Gen 2 Click

5V | 3.3V | SPI | I2C
 UART | GPIO | PWM | AN

The DS1087LU-266, a 3.3V spread-spectrum EconOscillator, from Maxim Integrated.

MSRP – \$17⁰⁰
 MIKROE-3076

mikroBUS standard

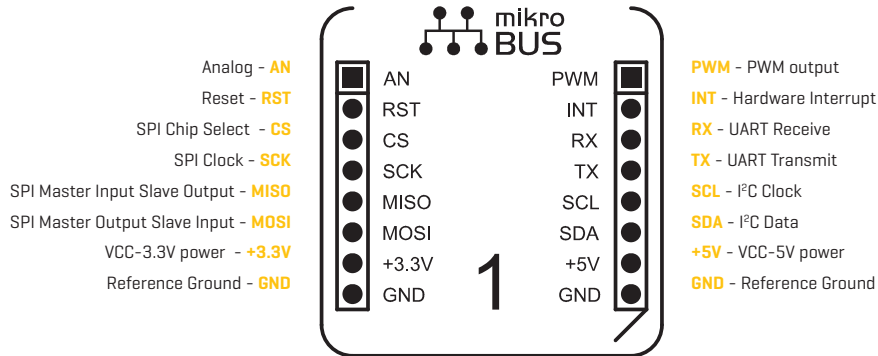

mikroBUS™ is a simple but effective pinout standard containing all the necessary pins to connect all the different Click boards™. There's also a range of mikroBUS™ shields that bring Click board connectivity to all of today's most popular development platforms (Arduino, Raspberry Pi, BeagleBone, Freedom, Discovery, Micro .NET and more).

Clicking on all platforms

Use Click boards™ with your favorite development platform. A range of Shields bring Click connectivity to:

- **Arduino**
- **BeagleBone Black**
- **Raspberry Pi**
- **Freedom**
- **Launchpad**
- **Discovery and more...**

See them all at: www.mikroe.com/Click/shields

mikroBUS Cape

MSRP – \$8⁹⁰
MIKROE-1857



NEW
Click board™
yet to come

NEW
Click board™
yet to come

NEW
Click board™
yet to come

NEW
Click board™
yet to come

NEW
Click board™
yet to come

Even though it was printed recently, the booklet you are holding is probably already outdated. That's because we release new Click boards™ weekly, sometimes daily. For the most current list of Click boards™, visit: www.mikroe.com/click

www.mikroe.com/click



X-ON Electronics

Largest Supplier of Electrical and Electronic Components

Click to view similar products for [Development Boards & Kits - Wireless](#) category:

Click to view products by [MikroElektronika](#) manufacturer:

Other Similar products are found below :

[13237ADC-SFTW](#) [13237ADC-BDM](#) [SLWRB4542B](#) [SLWRB4546A](#) [CC-WMX51-LX](#) [DA14586-00F02ATDB-P](#) [TWR-13237](#) [TWR-13237-KIT](#) [DA14585-00VVDB-P](#) [MKR MOTOR CARRIER](#) [AC164159](#) [RD-88MW322-R0](#) [RD-88MW320-R0](#) [FMC PCAM ADAPTER](#) [NFC TAG](#) [4 CLICK](#) [BLE 4 CLICK](#) [WRL-16984](#) [K32W-001-T10](#) [SLWRB4179B](#) [C METER CLICK](#) [HALL CURRENT CLICK](#) [COLOR 3 CLICK](#) [COMPASS 2 CLICK](#) [COMPASS CLICK](#) [HDC1000 CLICK](#) [RELAY CLICK](#) [RFID CLICK](#) [RIVERDI CLICK](#) [CUGSM113#UFL](#) [R METER](#) [CLICK](#) [MATRIX G CLICK](#) [MATRIX RGB CLICK](#) [3D MOTION CLICK](#) [3G SARA CLICK](#) [TDGL012](#) [4-20MA R CLICK](#) [4-20MA T](#) [CLICK](#) [THERMO CLICK](#) [MCP2003B CLICK](#) [EXPAND 3 CLICK](#) [MCP2542 CLICK](#) [MCP25625 CLICK](#) [ATA663211 CLICK](#) [ATA8520-EK3-E](#) [TOUCHKEY CLICK](#) [MICROSD CLICK](#) [TRF CLICK](#) [BUTTON R CLICK](#) [I2C ISOLATOR CLICK](#) [IR ECLIPSE CLICK](#)