 毫欧电阻 毫欧制造	HoGX封体合金系列规格书	系列号	HoGX
		修订日期	2019-11-25
		版本号	Ho-A0

规格书 Specification

制造商:深圳市毫欧电子有限公司

HoGX

适用: 本规格书适用于深圳市毫欧电子有限公司HoGX封体合金系列产品选型。

包含: HoGX1206/ HoGX2512/HoGX5931 等封装。

产品特点 Features:

高功率、低温漂、低阻值、高精度 (1%)

低电感设计, 小于1.0nH

卓越的可靠性和合适的成本。

适用于无铅焊接。

高精度修边工具。

符合RoHS标准, 无卤素。



产品名称 Product Name

封体合金电阻

产品型号 Product number

Ho	GX	2512	2W	10mR	1%	50ppm
制造商	产品系列	封装	额定功率(W)	阻值(mR)	精度(%)	温度系数 TCR (ppm)
毫欧电子	GX	1206	0.5W~1W	3 mR ~30mR	1%/2%/5%	50/70
		2512	1W ~3W	1mR ~220mR	1%/2%/5%	50/70/100
		5931	5W	3 /5/10	1%/2%/5%	70/100

具体参数请查看下页详情



地址: 深圳市龙华新区观澜大布头路南通邦高新产业园 A 栋 8 楼

■ 产品尺寸及结构 Dimension and Construction

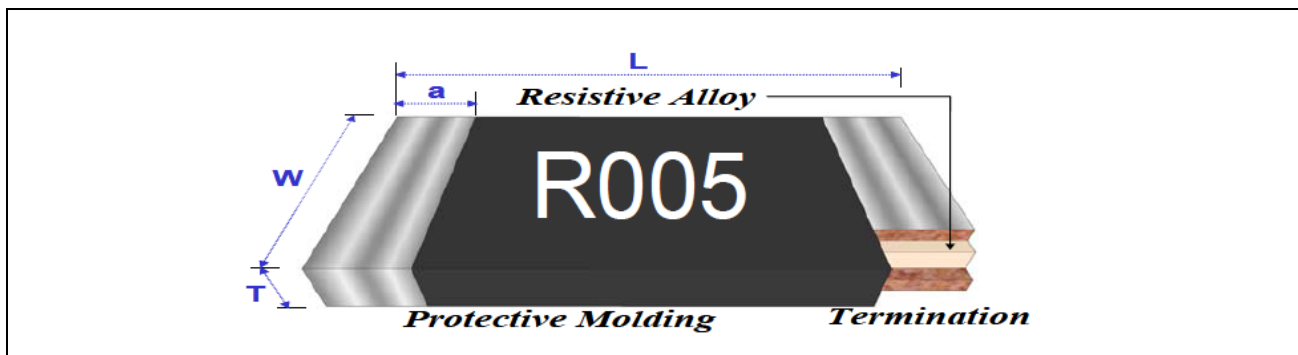

产品结构

项目	保护性模塑	电阻元件	内部终端	外部终端
材料	树脂	合金金属	铜	焊料

单位：mm

Type	Resistance	L	W	T	a
HoGX1206	5~30mR	3.10±0.20	1.65±0.20	0.60±0.20	0.60±0.20
HoGX2512	3~220mR	6.20±0.20	3.25±0.20	0.60±0.20	0.80±0.20
HoGX2512	3W series	6.20±0.20	3.25±0.20	0.65±0.20	0.80±0.20
HoGX2512	1~2mR	6.40±0.20	3.25±0.20	0.70±0.20	2.00±0.20
HoGX5931	2~10mR	15.0±0.20	7.80±0.20	0.70±0.20	3.50±0.20

■ 功率降额曲线 Power Derating Curve

工作温度范围：-55至+170摄氏度

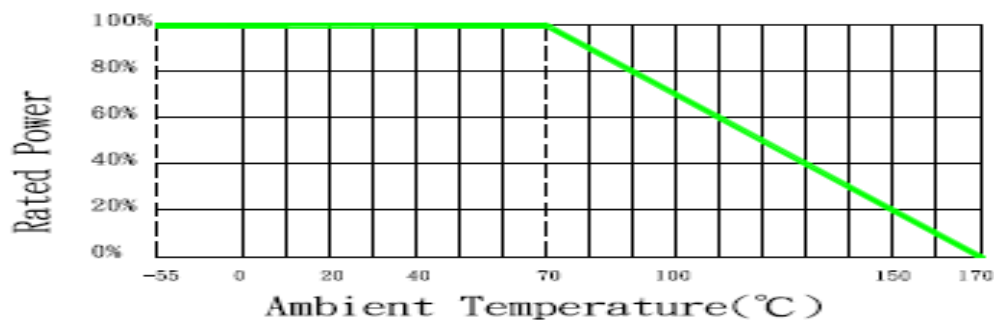

地址：深圳市龙华新区观澜大布头路南通邦高新产业园 A 栋 8 楼



HoGX封体合金系列规格书

系列号	HoGX
修订日期	2019-11-25
版本号	Ho-A0

■ 电气参数规格 Electrical parameter Specification (0.5~2W)

Rating Type	Tolerance (%)	Rating 70°C (W)	Max. Working Current (Voltage)*	Max. Overload Current (Voltage)*	Alloy Type	Temperature coefficient of Resistance (ppm/°C)**	Resistance (mΩ) ***
HoGX1206	±1%(F) ±2%(G) ±5%(J)	0.5	12.9A (111mV)	28.9A (250mV)	Low EMF	±70	3,4,5,6,9,10, 15,20,25
			10.0A (111mV)	22.4A (250mV)	Standard	±50	5,10,15,15.5 18,20,25,30
		1	18.3A (158mV)	40.8A (354mV)	Low EMF	±70	3,4,5,6,9,10 15,20,25
			14.1A (173mV)	31.6A (387mV)	Standard	±50	5,10,15,15.5 18,20,25,30
HoGX2512	±1%(F) ±2%(G) ±5%(J)	1	31.6A (158mV)	70.7A (354mV)	Low EMF	±70	1,2,2.5,3,4,5 10,15,20,25
			18.3A (469mV)	40.8A (1049mV)	Standard	±50	3,4,5,6,7,8,9,10 12,15,20,22,25,30 33,35,40,50,60,70 75,80,100,200,220
		2	44.7A (224mV)	100A (500mV)	Low EMF	±70	1,2,2.5,3,4,5 10,15,20,25
			25.8A (663mV)	57.7A (1483mV)	Standard	±50	3,4,5,6,7,8,9,10 12,15,20,22,25,30 33,35,40,50,60,70 75,80,100,200,220

Note:

- (i) $= \sqrt{P * R}$ or Max. Working Voltage whichever is lower.
- (ii) : Working Voltage(V) · P : Rated Power (W) · R : Resistance Value(Ω)
- (iii) Solder-pad and trace size should be >300 mm² and board surface temperature should not exceed 105°C when applying rated power
- (iv) * : Related number are depend on specific items only. ** : TCR Hot (+25~+155°C).
*** : Special requests and details please contact factory.

地址：深圳市龙华新区观澜大布头路南通邦高新产业园 A 栋 8 楼

 毫欧电阻 毫欧制造	HoGX封体合金系列规格书	系列号	HoGX
		修订日期	2019-11-25
		版本号	Ho-A0

■ 电气参数规格Electrical parameterSpecification(3~5W)

Rating Type	Rating 70°C (W)	Max. Working Current (Voltage)*	Max. Overload Current (Voltage)*	Resistance Tolerance (%)	Temperature coefficient of Resistance (ppm/°C)**	Resistance (mΩ) ***
HoLR2512 低电磁波	3	31.6A (245mV)	70.7A (548mV)	±1%(F) ±2%(G) ±5%(J)	±70	3,4,5,6,7,8,9,
					±50	
HoLR2512 标准	3	24.5A (812mV)	54.8A (1817mV)	±1%(F) ±2%(G) ±5%(J)	±70	5,6,8
					±50	12,14,15,16,18,20 25,30,33,35,40,50 60,75,80,100 200,220
HoLR5931 标准	5	40.8A (224mV)	91.3A (500mV)	±1%(F) ±2%(G) ±5%(J)	±100	
					±70	5

Note:

(v) $E = \sqrt{P \cdot R}$ or Max. Working Voltage whichever is lower.

(vi) E : Working Voltage(V) , P : Rated Power (W) , R : Resistance Value(Ω)

(vii) Solder-pad and trace size should be >300 mm² and board surface temperature should not exceed 105°C when applying rated power

(viii) * : Related number are depend on specific items only. ** : TCR Hot (+25~+155°C). *** : Special requests and details please contact factory.

■ 标记Marking

HoGX1206/HoGX2512/HoGX5931

TOP: Marking. (4 Digits marking to identify the resistance value.)

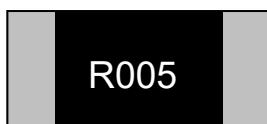

R005=5mΩ

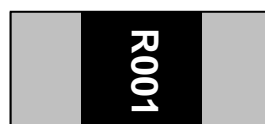

R001=1 mΩ

地址：深圳市龙华新区观澜大布头路南通邦高新产业园 A 栋 8 楼

建议焊盘尺寸 Recommended Solder Pad Dimension

Type	W	D	L
HoGX1206	1.80	1.30	4.70
HoGX2512	3.70	1.60	7.60
HoGX2512 R001/R002	4.00	3.00	7.30
HoGX5931	8.75	6.00	17.60

Unit:mm

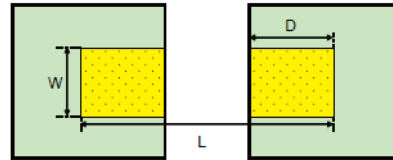
可靠性性能 Reliability Performance

标准品常规检验项目

Test Item	Specification	Test Method (AEC-Q200. IEC 60115)
*DC Resistance	F : $\pm 1\%$ 、G : $\pm 2\%$ 、J : $\pm 5\%$	AEC-Q200 TABLE 7.1 IEC 60115-1 / JIS C 5201-1 , Clause 4.5 Measure the resistance Value.
High Temperature Exposure (Storage)	J、G : $\Delta R \leq \pm(3\%+0.5m\Omega)$ F : $\Delta R \leq \pm(1\%+0.5m\Omega)$	AEC-Q200 TABLE 7.3 1000 hrs. @ T=125°C. Unpowered. Measurement at 24 ± 2 hours after test conclusion.
*Temperature Cycling	J、G : $\Delta R \leq \pm(1\%+1m\Omega)$ F : $\Delta R \leq \pm(0.5\%+1m\Omega)$ No mechanical damage.	AEC-Q200 TABLE 7.4 1000 Cycles (-55°C to +125°C). Measurement at 24 ± 2 hours after test conclusion.
Moisture Resistance	J、G : $\Delta R \leq \pm(1\%+0.5m\Omega)$ F : $\Delta R \leq \pm(0.5\%+0.5m\Omega)$	AEC-Q200 TABLE 7.6 Test 65°C/80~100%RH/10Cycles. Measurement at 24 ± 2 hours after test conclusion. (t=24hrs/cycle).
Biased Humidity	J、G : $\Delta R \leq \pm(3\%+0.5m\Omega)$ F : $\Delta R \leq \pm(1\%+0.5m\Omega)$	AEC-Q200 TABLE 7.7 1000 hours 85°C/85%RH. 10% of operating power. Measurement at 24 ± 2 hours after test conclusion.
Operational Life	J、G : $\Delta R \leq \pm(3\%+0.5m\Omega)$ F : $\Delta R \leq \pm(1\%+0.5m\Omega)$	AEC-Q200 TABLE 7.8 Test 1000hr @ TA=125°C at specified rated power. Measurement at 24 ± 2 hours after test conclusion.

地址：深圳市龙华新区观澜大布头路南通邦高新产业园 A 栋 8 楼

 毫欧电阻 毫欧制造	HoGX封体合金系列规格书	系列号	HoGX
		修订日期	2019-11-25
		版本号	Ho-A0

■ 可靠性性能 **Reliability Performance**

External Visual	No visual damage and refer PDC marking code.	AEC-Q200 TABLE 7.9 Inspect device construction, marking and workmanship.
Physical Dimension	Within the spec.	AEC-Q200 TABLE 7.10 Verify physical dimensions to the applicable device detail specification.
Mechanical Shock	Within product specification tolerance and no visible damage.	AEC-Q200 TABLE 7.13 Test Peak value:100g's,Wave:Hail-sine, Duration:6ms,Velocity:12.3ft/sec.
Vibration	No mechanical damage.	AEC-Q200 TABLE 7.14 5 g's for 20 min., 12 cycles each of 3 orientations. Test from 10-2000 Hz.
*Resistance to Solder Heat	J、G : $\Delta R \leq \pm(1\% + 0.5m\Omega)$ F : $\Delta R \leq \pm(0.5\% + 0.5m\Omega)$ No mechanical damage.	AEC-Q200 TABLE 7.15 Solder dipping @ 270°C $\pm 5^\circ\text{C}$ for 10sec. ± 1 sec.
Thermal Shock	J、G : $\Delta R \leq \pm(1\% + 0.5m\Omega)$ F : $\Delta R \leq \pm(0.5\% + 0.5m\Omega)$ No mechanical damage.	AEC-Q200 TABLE 7.16 -55 to 155°C/ dwell time 15min/ Max transfer time 20sec/ 300cycles.
ESD	$\Delta R \leq \pm(1\% + 0.5m\Omega)$ No mechanical damage.	AEC-Q200-002 Test contact min. 1KV.
*Solder Ability	Over 95% of termination must be covered with solder.	AEC-Q200 TABLE 7.18 a)Baking 155°C 4H, dipping 235°C 5s b)Steam 1H, dipping 215°C 5s c)Steam 1H, dipping 260°C 7s
Flammability	Refer UL-94.	AEC-Q200 TABLE 7.20 UL-94 V-0 or V-1 are acceptable
*Board Flex	J、G : $\Delta R \leq \pm(1\% + 1m\Omega)$ F : $\Delta R \leq \pm(0.5\% + 1m\Omega)$ No mechanical damage.	AEC-Q200 TABLE 7.21 Bending 2mm 5931.2512.1206
Terminal Strength	No mechanical damage	AEC-Q200 TABLE 7.22 Force 1 Kg for 60 seconds.
*Short Time Overload	J、G : $\Delta R \leq \pm(2\% + 0.5m\Omega)$ F : $\Delta R \leq \pm(1\% + 0.5m\Omega)$	IEC 60115-1, Clause 4.13 5 × Rated power for 5 seconds

地址：深圳市龙华新区观澜大布头路南通邦高新产业园 A 栋 8 楼

 毫欧电阻 毫欧制造	HoGX封体合金系列规格书	系列号	HoGX
		修订日期	2019-11-25
		版本号	Ho-A0

■ 可靠性能 **Reliability Performance**

*Load Life Humidity	J、G : $\Delta R \leq \pm(3\%+0.5m\Omega)$ F : $\Delta R \leq \pm(1\%+0.5m\Omega)$	IEC 60115-1, Clause 4.24 40±2°C with relative humidity 90% ~ 95% D.C. rated voltage for 1.5 hours ON 30 minutes OFF. Cycle repeated 1000 hours.
*Temperature Coefficient of Resistance (TCR)	Within the spec.	IEC 60115-1, Clause 4.8 Test temperature : 25°C ~ +155°C TCR(ppm/°C) = $(R_2-R_1)/R_1 \times 1 / (T_2-T_1) \times 10^6$ (+25~ -55°C please contact factory.)
*Load Life	J、G : $\Delta R \leq \pm(3\%+0.5m\Omega)$ F : $\Delta R \leq \pm(1\%+0.5m\Omega)$	IEC 60115-1, Clause 4.25 Rated voltage for 1.5 hours for followed by a pause 0.5 hour at 70±2°C . Cycle repeated 1000 hours.
*Insulation Resistance	Between termination and coating must over 1000MΩ	IEC 60115-1, Clause 4.6 Test voltage : 100±15V

■ 顶盖胶带剥离强度 **Peel Strength of Top Cover Tape**

剥离速度约为300 mm/min
顶盖胶带的剥离力应在0.1~0.7N之间

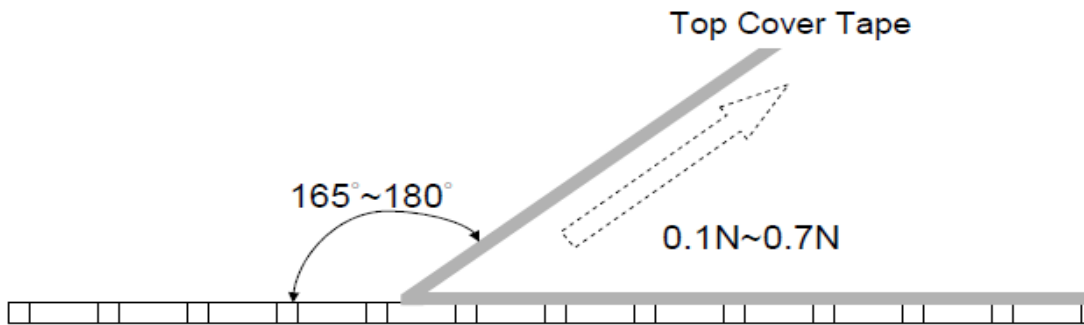

地址：深圳市龙华新区观澜大布头路南通邦高新产业园 A 栋 8 楼

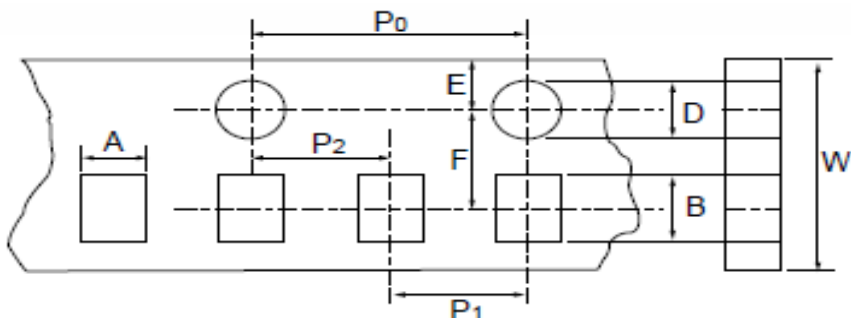
■ 彩带尺寸 Ribbon size(Unit:mm)

• Accumulated dimensional tolerance $40\pm 0.2\text{mm}$

Size	A	B	W	F	E	P1	P2	P0	D
1206	2.00 ± 0.20	3.60 ± 0.20	8.00 ± 0.30	3.50 ± 0.05	1.75 ± 0.10	4.00 ± 0.10	2.00 ± 0.05	4.00 ± 0.10	1.50 ± 0.10
2512	3.50 ± 0.20	6.75 ± 0.20	12.0 ± 0.30	5.50 ± 0.05	1.75 ± 0.10	4.00 ± 0.10	2.00 ± 0.05	4.00 ± 0.10	1.50 ± 0.10
5931	8.20 ± 0.10	15.4 ± 0.10	24.0 ± 0.30	11.5 ± 0.10	1.75 ± 0.10	12 ± 0.10	2.00 ± 0.10	4.00 ± 0.10	1.50 ± 0.10

unit : mm

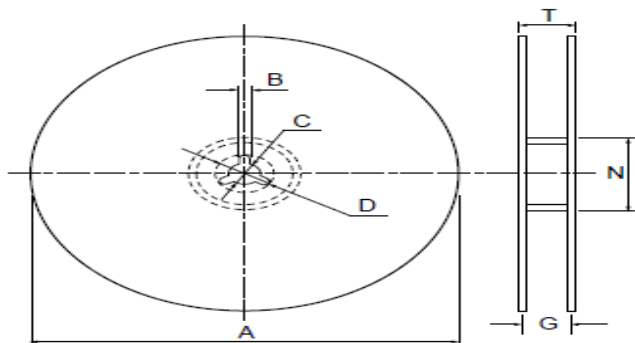
■ 卷轴规格 Reel Specification

Size	Packaging Q'ty	A	N	C	D	B	G	T
1206	4kpcs/Reel	178.0 ± 2.0	60.0 ± 0.5	13.0 ± 0.5	20(Min.)	2.0 ± 0.5	10.0 ± 1.5	14.9max.
2512	4kpcs/Reel	178.0 ± 2.0	0.0 ± 0.5	13.0 ± 0.5	20(Min.)	2.0 ± 0.5	13.8 ± 1.5	16.7max.
	8kpcs/Reel	254.0 ± 2.0	100.0 ± 0.5	13.5 ± 0.5	20(Min.)	2.0 ± 0.5	13.8 ± 1.5	20.0max.
	16kpcs/Reel	330.0 ± 2.0	00.0 ± 1.0	13.5 ± 0.5	20(Min.)	2.0 ± 0.5	13.8 ± 1.5	20.0max.
5931	3kpcs/Reel	330.0 ± 2.0	99.5 ± 1.0	13.0 ± 0.5	20(Min.)	2.0 ± 0.5	24.0 ± 1.0	28.6max.

地址：深圳市龙华新区观澜大布头路南通邦高新产业园 A 栋 8 楼

X-ON Electronics

Largest Supplier of Electrical and Electronic Components

Click to view similar products for [Current Sense Resistors - SMD category](#):

Click to view products by [Milliohm manufacturer](#):

Other Similar products are found below :

[5112](#) [65709-330JE](#) [PF2512FKF7W0R007L](#) [PR2512FKF7W0R003L](#) [PR2512FKF7W0R005L](#) [RCWL0603R500JNEA](#) [ERJ-3BQF1R1V](#) [ERJ-L14UJ42MU](#) [2-2176088-5](#) [PF2512FKF7W0R006L](#) [PF2512FKF7W0R033L](#) [2-2176089-4](#) [CD2015FC-0.10-1%](#) [PR2512FKF7W0R004L](#) [CGSSL1R01J](#) [CGSSL1R047J](#) [RC1005F124CS](#) [RCWE2512R110FKEA](#) [RCWL0805R330JNEA](#) [RL73H3AR47FTE](#) [RL73K3AR56JTDF](#) [RL7520WT-R001-F](#) [RL7520WT-R009-G](#) [RL7520WT-R020-F](#) [RLP73N1ER43JTD](#) [TL3AR01FTDG](#) [TLR3A20DR0005FTDG](#) [LRC-LR2512LF-01-R820J](#) [ERJ-3BQF4R3V](#) [ERJ-L14UF68MU](#) [TLR3A20DR001FTDG](#) [TLR3A30ER0005FTDG](#) [WR06X104JGLJ](#) [RLP73K1ER82JTD](#) [TL2BR01F](#) [TLR3A20DR01FTDG](#) [WSR3R0600FEA32](#) [ERJ-14BQF1R6U](#) [ERJ-14BQJR30U](#) [SP1220RJT](#) [SP1R12J](#) [ERJ-14BQF6R2U](#) [RL7520WT-R039-G](#) [PF1206FRF7W0R02L](#) [RL7520WT-R002-F](#) [RL7520WT-R047-F](#) [RLP73N2BR068FTDF](#) [RL7520WT-R005-F](#) [RCWE2512R220FKEA](#) [RCWE120625L0FMEA](#)