



HoCR1812贴片陶瓷系列规格书

系列号	HoCR1812
修订日期	2019-10-28
版本号	Ho-A0

规格书 Specification

制造商:深圳市毫欧电子有限公司

HoCR1812

适用: 本规格书适用于深圳市毫欧电子有限公司贴片陶瓷电阻 HoCR1812 系列产品选型。

产品特点 Features:

- 家用电器体积小、重量轻
- 高可靠性、高质量
- 电阻温度系数 $TCR \times 10^{-6}/^{\circ}C \leq 100ppm \sim 1800ppm$
- 符合 ROHS 要求



产品名称 Product Name

贴片陶瓷电阻

产品型号 Product number

Ho	CR	1812	0.75W	1R	1%	300ppm
供应商	产品系列	封装	额定功率(W)	阻值(R)	精度(%)	温度系数 TCR (ppm)
Ho 毫欧电子	CR 贴片陶瓷	1812	0.75W 1W	10mR~990mR	1%/ 5%	600/800/1800
			0.75W	1R~10R	1%/2% /5%	300
				10.2R~10MR	5%	200
				10.2R~1MR	0.1%/0.5%	100
			10.2R~10MR	1%/ 2%	100	



地址: 深圳市龙华新区观澜大布头路南通邦高新产业园 A 栋 8 楼



HoCR1812 贴片陶瓷系列规格书

系列号	HoCR1812
修订日期	2019-10-28
版本号	Ho-A0

■ 产品尺寸 Product Size

产品尺寸:			Unit: mm		
型号	L	W	H	l1	l2
HoCR1812	4.50 ± 0.10	3.10 ± 0.20	0.55 ± 0.05	0.55 ± 0.20	0.70 ± 0.20

■ 电气参数 Electrical parameter

额定功率 Rated power	0.75W
阻值范围 Resistance range	10mR~10MR
额定压降 Max. Operating Voltage	200V~400V
准确度等级 AccuracyClass	$\pm 0.1\% \sim \pm 5\%$
电阻温度系数 T.C.R (ppm / °C)	$\pm 100 \sim \pm 1800$
工作温度范围 Operating Temperature Range	$-55^{\circ}\text{C} \sim +155^{\circ}\text{C}$

■ 功率曲线 Power curve

操作温度范围 -55 ~ +155 °C 电阻温度达到 70°C 时降功率示意图

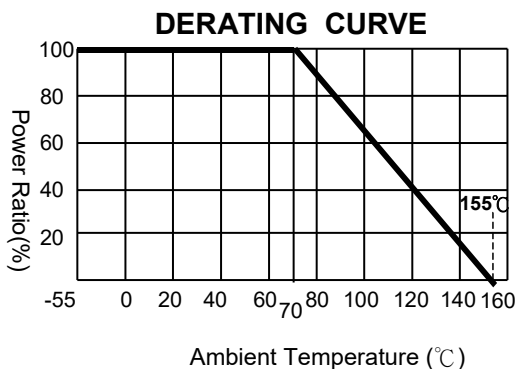

Power rating or current rating is in the case based on continuous full-load at ambient temperature of 70 °C .
For operation at ambient temperature in excess of 70 °C , the load should be derated in accordance with figure of derating Curve.

地址：深圳市龙华新区观澜大布头路南通邦高新产业园 A 栋 8 楼

系列号	HoCR1812
修订日期	2019-10-28
版本号	Ho-A0

■ 建议焊盘尺寸 Recommended Solder Pad Dimension

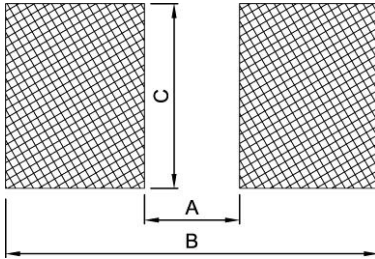

型号	A(mm)	B(mm)	C(mm)
HoCR1812	3.11	5.91	3.3

■ 低功率电气规范 Low Power Electrical Specifications

Item Type	Rated Power at 70°C	Rated Voltage Range	Max Overload Voltage	T.C.R (PPM/°C)	Resistance Range (mΩ)
					F(±1%)、J(±5%)
HoCR1812	0.75 W 1W	0.08~0.8V	2.15 V	±1800	10~50
				±800	51~100
				±600	101~990

■ 可调片电阻-TCR系列 Adjustable chip resistance TCR series

Item Type	Rated Power at 70°C	Max Working Voltage	Max Overload Voltage	T.C.R (PPM/°C)	Resistance Tolerance	Resistance Range
		200V	400V	±200	±15%	10Ω~1MΩ
HoCR1812	0.75 W				±20%	
					±30%	

地址：深圳市龙华新区观澜大布头路南通邦高新产业园 A 栋 8 楼



HoCR1812贴片陶瓷系列规格书

系列号	HoCR1812
修订日期	2019-10-28
版本号	Ho-A0

■ 可靠性试验及要求 Reliability test and Requirement

Test Item	Test Method	Procedure	Requirements
Temperature Coefficient of Resistance (T.C.R)	JIS C 5201-1 clause 4.8	-55°C or +155°C, 25°C is the reference temperature	Refer to Ratings
Short Time Overload	JIS C 5201-1 clause 4.13	General : 2.5 times RCWV or Max. Overload voltage whichever is less for 5 seconds.	±1 : ±(1.0%+0.05Ω) ±5 : ±(2.0%+0.1Ω) Value <1Ω : ±(2.0%+0.1Ω)
IR Reflow	Sony SS-00254	<p>Peak : 250⁺⁵ °C 230°C or higher</p> <p>180°C --- Pre Heating Zone</p> <p>150°C --- 90 ± 30 s</p> <p>30 ± 10 s Soldering Zone</p> <p>Heating Time</p>	±1 : ±(1.0%+0.05Ω) ±5 : ±(1.0%+0.05Ω)
Leaching	Sony SS-00254-9	260±5°C for 30 seconds.	>95% Coverage
Soldering Heat	JIS C 5201-1 clause 4.18	260±5°C for 10 seconds.	±1 : ±(0.5%+0.05Ω) ±5 : ±(1.0%+0.05Ω) Value <1Ω : ±(1.0%+0.05Ω)
Temperature Cycling	JIS C 5201-1 clause 4.19	-55°C to +155°C, 5 cycles	0.1%、0.5%、1% : ±(0.5%+0.05Ω) 2%、5% : ±(1.0%+0.10Ω) Value <1Ω : ±(1.0%+0.10Ω)
Electric Iron	Sony SS-00254-5	Preheating temperature : 350±10°C Electric iron preheating time : 3+1/-0 sec	±1 : ±(1.0%+0.05Ω) ±5 : ±(1.0%+0.05Ω) Value <1Ω : ±(1.0%+0.05Ω)
Resistance to Solvent	JIS C 5201-1 clause 4.29	The tested resistor be immersed into isopropyl alcohol of 20~25°C for 60 secs. Then the resistor is left in the room for 48 hrs.	±1 : ±(0.5%+0.05Ω) ±5 : ±(0.5%+0.05Ω) Value <1Ω : ±(1.0%+0.05Ω)
Load Life in Humidity	JIS C 5201-1 clause 4.24	40±2°C, 90~95% R.H. RCWV or Max. working voltage whichever is less for 1000 hrs with 1.5 hrs "ON" and 0.5 hr "OFF" .	0.1%、0.5%、1% : ±(1.0%+0.05Ω) 2%、5% : ±(2.0%+0.05Ω) Value <1Ω : ±(2.0%+0.05Ω)
Load Life (Endurance)	JIS C 5201-1 clause 4.25	70±2°C, RCWV or Max. working voltage whichever is less for 1000 hrs with 1.5 hrs "ON" and 0.5 hr "OFF" .	0.1%、0.5%、1% : ±(1.0%+0.05Ω) 2%、5% : ±(3.0%+0.10Ω) Value <1Ω : ±(3.0%+0.10Ω)
Insulation Resistance	JIS C 5201-1 clause 4.6	100V for 1 minute.	≥ 10GΩ
Terminal Bending Strength	JIS C 5201-1 clause 4.33	Bending once for 5 seconds D : 0402、0603、0805=5mm 1206、1210、1812=3mm 2010、2512=2mm	±1 : ±(1.0%+0.05Ω) ±5 : ±(1.0%+0.05Ω)

地址：深圳市龙华新区观澜大布头路南通邦高新产业园 A 栋 8 楼

系列号	HoCR1812
修订日期	2019-10-28
版本号	Ho-A0

■ 卷轴规格 / 包装方式 **Reel Specification / Packing**

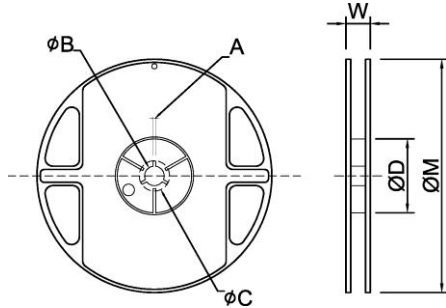

■ Dimension

Unit: mm

TYPE	SIZE	A	ϕB	ϕC	ϕD	W	ϕM
HoCR1812	7" 4K/Reel	2.0±0.5	13.5±1.0	21±1.0	60±1.0	16.0±2.0	178±2.0

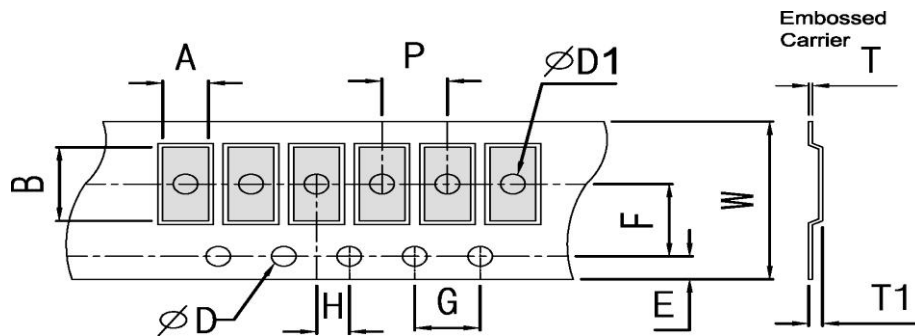

■ Dimension

Unit: mm

Packaging	Type	A	B	W	E	F	G	H	T	ϕD	$\phi D1$	T1	P
Embossed Type	1812	3.30±0.2	4.60±0.2	12±0.1	1.75±0.1	5.5±0.05	4.0±0.1	2.0±0.05	0.23±0.1	1.50 ^{+0.10} ₋₀	1.50±0.1	0.85±0.15	4.0±0.1

地址：深圳市龙华新区观澜大布头路南通邦高新产业园 A 栋 8 楼

 毫欧电阻 毫欧制造	HoCR1812 贴片陶瓷系列规格书	系列号	HoCR1812
		修订日期	2019-10-28
		版本号	Ho-A0

■ 前后引线尺寸 **Front & Back Lead Dimension**

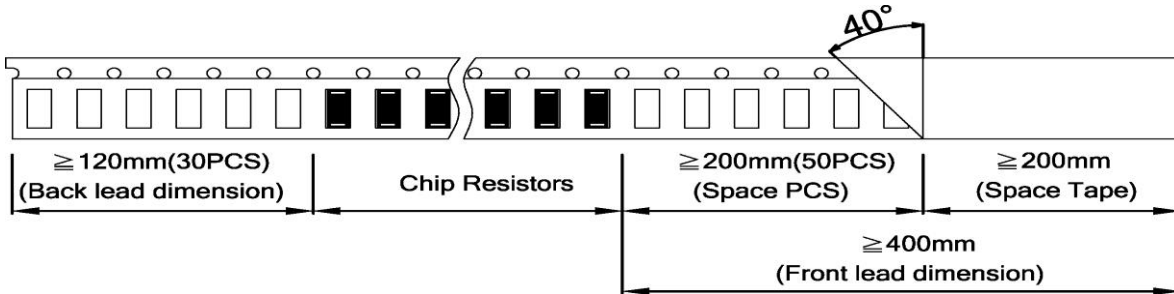

■ 上胶剥离强度: 10~70g **Top Adhesive Peel Off Strength: 10~70g**

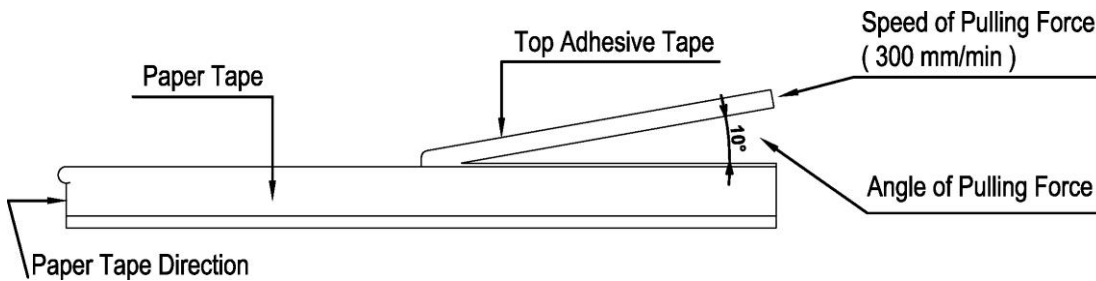

地址：深圳市龙华新区观澜大布头路南通邦高新产业园 A 栋 8 楼

X-ON Electronics

Largest Supplier of Electrical and Electronic Components

Click to view similar products for [Thick Film Resistors - SMD category](#):

Click to view products by [Milliohm manufacturer](#):

Other Similar products are found below :

[CR-05FL7--150R](#) [CR-05FL7--19K6](#) [CR-05FL7--243R](#) [CR-05FL7--40K2](#) [CR-05FL7--698K](#) [CR-12FP4--324R](#) [CR-12JP4--680R](#)
[M55342K06B1E78RS3](#) [M55342K06B6E19RWL](#) [M55342K06B6E81RS3](#) [M55342M05B200DRWB](#) [M55342M06B4K70MS3](#) [MC0603-511-](#)
[JTW](#) [742C083750JTR](#) [MCR01MZPF1202](#) [MCR01MZPF1601](#) [MCR01MZPF1800](#) [MCR01MZPF6201](#) [MCR01MZPF9102](#) [MCR01MZPJ113](#)
[MCR01MZPJ121](#) [MCR01MZPJ125](#) [MCR01MZPJ751](#) [MCR03EZHJ103](#) [MCR03EZPFX2004](#) [MCR03EZPJ270](#) [MCR03EZPJ821](#)
[MCR10EZPF1102](#) [MCR18EZPJ330](#) [RC0603F1473CS](#) [RC0603F150CS](#) [RC1005F1152CS](#) [RC1005F1182CS](#) [RC1005F1372CS](#)
[RC1005F183CS](#) [RC1005F1911CS](#) [RC1005F1912CS](#) [RC1005F203CS](#) [RC1005F2052CS](#) [RC1005F241CS](#) [RC1005F2431CS](#)
[RC1005F3011CS](#) [RC1005F303CS](#) [RC1005F4321CS](#) [RC1005F4642CS](#) [RC1005F471CS](#) [RC1005F4751CS](#) [RC1005F5621CS](#)
[RC1005F6041CS](#) [RC1005J106CS](#)