 毫欧电阻 毫欧制造	HoT2512D-0R系列规格书	系列号	HoT
		修订日期	2020-5-18
		版本号	Ho-A0



规格书 Specification

制造商:深圳市毫欧电子有限公司

HoT2512D

适用: 本规格书适用于深圳市毫欧电子有限公司封体合金电阻 HoT2512D 系列产品选型。

■ 产品特点 Features:

封体工艺, 焊接性能良好

高可靠性, 高过载能力, 产品精度高。

使用温度范围较宽无感型设计

电阻温度系数 $TCR \times 10^{-6}/^{\circ}C \leq 25ppm \sim 50ppm$

符合 ROHS 要求和无卤要求

■ 产品名称 Product Name

封体合金电阻

■ 产品型号 Product number

Ho	T	2512D	2W	0R	1%	25ppm
制造商	系列号	产品封装	额定功率	阻值	精度	温漂TCR (ppm/°C)
毫欧电子	贴片跳线	2512D	1W/2W/3W	0R	1%	25~50



地址: 深圳市龙华新区观澜大布头路南通邦高新产业园 A 栋 8 楼

 毫欧电阻 毫欧制造	HoT2512D-0R系列规格书	系列号	HoT
		修订日期	2020-05-18
		版本号	Ho-A0

■ 产品尺寸 Product Size

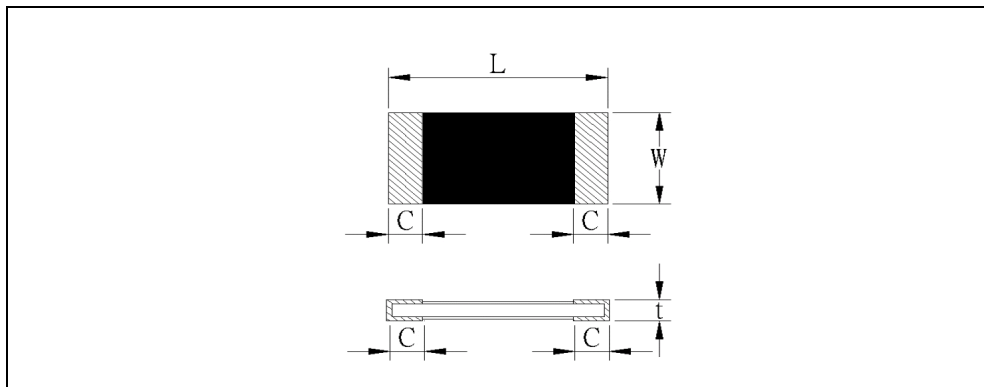

产品尺寸:

型号	阻值	L	W	C	T
HoT2512D	0R	6.4 ± 0.25	3.2 ± 0.25	1.1 ± 0.25	0.8 ± 0.25

■ 电气参数 Electrical parameter

额定功率 Rated power	1W/2W/3W
额定电流 Max.Rated Current	80A
最大电流 Max.Rated Current	160A
准确度等级 AccuracyClass	一致性1%
电阻温度系数 T.C.R (ppm / °C)	25~50
工作温度范围 Operating Temperature Range	-55°C~+170°C

■ 功率曲线 Power curve

操作温度范围 -55 ~+170 °C 电阻温度达到 70°C时降功率示意图

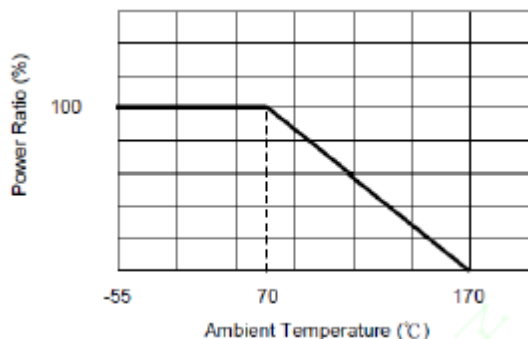

地址：深圳市龙华新区观澜大布头路南通邦高新产业园 A 栋 8 楼

系列号	HoT
修订日期	2020-05-18
版本号	Ho-A0

■ 额定电流计算公式 The rated current is calculated by the following Formu

I :Rated Current (A)

P:Rated Power (W)

R:Resistance Value (Ω)

$$I = \sqrt{P/R}$$

■ 建议焊盘尺寸 Recommended Solder Pad Dimension



单位: mm

阻值	a	b	L
0mR	4	2.1	4.1

■ 建议焊接参数 / Recommended Customer Soldering Parameters

预热: 150 to 180 °C, 90±30秒, 焊接区: 230°C 或更高, 30±10 秒
峰值: 260±5°C, 5秒.

回流焊曲线图

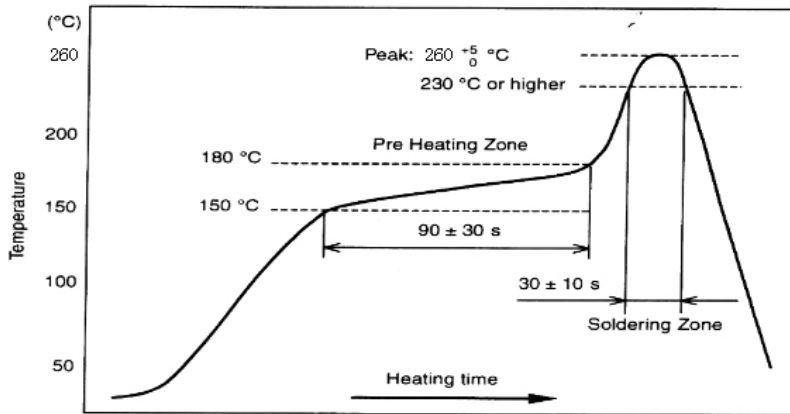

地址: 深圳市龙华新区观澜大布头路南通邦高新产业园 A 栋 8 楼

■ 彩带尺寸 Ribbon size(Unit:mm)

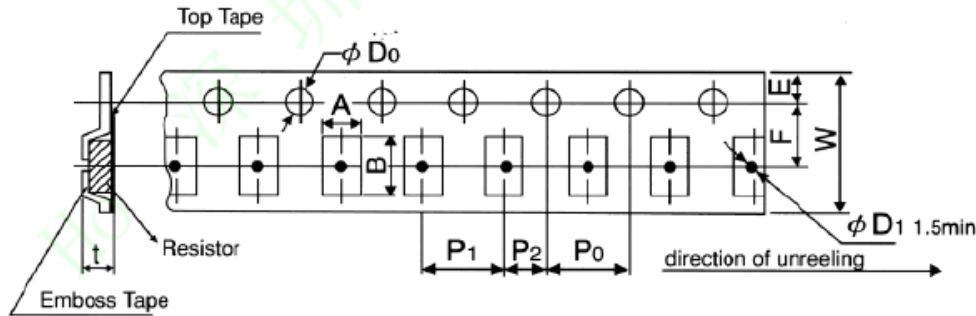

A	B	W	F	E	P1	P2	P0	D0	T
3.6±0.2	6.9±0.2	12±0.2	5.5±0.05	1.75±0.1	4.0±0.1	2±0.05	4±0.05	Φ 1.5±0.1	1.2±0.15

■ 可靠性测试 Reliability Tests

Test Items	Reference standard	Condition of Test	Test Limits
Temperature Coefficient of Resistance	IEC60115-1 4.4.8 JIS C 5201-1 4.4.8	+25°C ~ +125°C	Refer 4.0
Load Life	IEC60115-1 4.25.1 JIS C 5201-1 4.25.1	1000hours at rated power, 70°C, 1.5hours "ON", 0.5hour "OFF"	< ±1%
Short Time Overload	IEC60115-1 4.13 JIS C 5201-1 4.13	5 X rated power for 5s	< ±0.5%
Moisture no Load	IEC60115-1 4.24.2.1a) JIS C 5201-1 4.24.2.1a)	85°C, 85%RH, 1000hrs	< ±1%
Temperature cycle	IEC60115-1 4.19 JIS C 5201-1 4.19	-55°C & +155°C, 300cycle, 15min per extreme condition	< ±0.5%
Resistance to Soldering Heat	IEC60115-1 4.18 JIS C 5201-1 4.18	260±5°C for 20±1 sec	< ±0.5%
Solderability	IEC60115-1 4.17 JIS C 5201-1 4.17	245±5°C, 2±0.5sec	At least 95% of surface area of electrode shall be covered with new solder
High Temperature Exposure	IEC60115-1 4.23.2 JIS C 5201-1 4.23.2	170°C, 1000hrs	< ±1%
Low Temperature Storage	IEC60115-1 4.23.4 JIS C 5201-1 4.23.4	-55°C, 1000hrs	< ±0.5%
Substrate Bending	IEC60115-1 4.33 JIS C 5201-1 4.33	Bending width 2mm	< ±1%
Insulation Resistance	IEC60115-1 4.6 JIS C 5201-1 4.6	100V DC for 1 minute	>100 MΩ

地址：深圳市龙华新区观澜大布头路南通邦高新产业园 A 栋 8 楼



HoT2512D-0R系列规格书

系列号	HoT
修订日期	2020-05-18
版本号	Ho-A0

■ 卷轴规格 Reel Specification

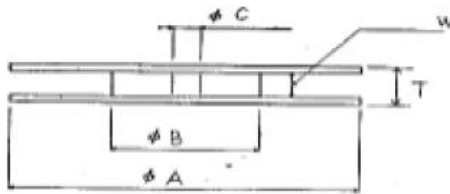
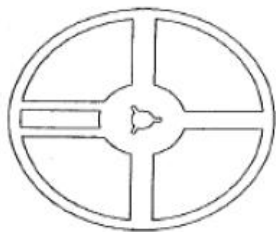

ΦA	ΦB	ΦC	W	T
180+0/-3	60±1	13±1	13±1	15.4±2

■ 包装方式 Packing

编带盘装：4000PCS/盘

地址：深圳市龙华新区观澜大布头路南通邦高新产业园 A 栋 8 楼

X-ON Electronics

Largest Supplier of Electrical and Electronic Components

Click to view similar products for [Current Sense Resistors - SMD category](#):

Click to view products by [Milliohm manufacturer](#):

Other Similar products are found below :

[5112](#) [65709-330JE](#) [PF2512FKF7W0R007L](#) [PR2512FKF7W0R003L](#) [PR2512FKF7W0R005L](#) [RCWL0603R500JNEA](#) [ERJ-3BQF1R1V](#) [ERJ-L14UJ42MU](#) [2-2176088-5](#) [PF2512FKF7W0R006L](#) [PF2512FKF7W0R033L](#) [2-2176089-4](#) [CD2015FC-0.10-1%](#) [PR2512FKF7W0R004L](#) [CGSSL1R01J](#) [CGSSL1R047J](#) [RC1005F124CS](#) [RCWE2512R110FKEA](#) [RCWL0805R330JNEA](#) [RL73H3AR47FTE](#) [RL73K3AR56JTDF](#) [RL7520WT-R001-F](#) [RL7520WT-R009-G](#) [RL7520WT-R020-F](#) [RLP73N1ER43JTD](#) [TL3AR01FTDG](#) [TLR3A20DR0005FTDG](#) [LRC-LR2512LF-01-R820J](#) [ERJ-3BQF4R3V](#) [ERJ-L14UF68MU](#) [TLR3A20DR001FTDG](#) [TLR3A30ER0005FTDG](#) [WR06X104JGLJ](#) [RLP73K1ER82JTD](#) [TL2BR01F](#) [TLR3A20DR01FTDG](#) [WSR3R0600FEA32](#) [ERJ-14BQF1R6U](#) [ERJ-14BQJR30U](#) [SP1220RJT](#) [SP1R12J](#) [ERJ-14BQF6R2U](#) [RL7520WT-R039-G](#) [PF1206FRF7W0R02L](#) [RL7520WT-R002-F](#) [RL7520WT-R047-F](#) [RLP73N2BR068FTDF](#) [RL7520WT-R005-F](#) [RCWE2512R220FKEA](#) [RCWE120625L0FMEA](#)