

INTERCONNECTS

SERIES 800 & 801 • 2,54 GRID (0,76 DIA. PINS), STRAIGHT & RIGHT ANGLE HEADERS AND SOCKETS • SINGLE ROW STRIPS

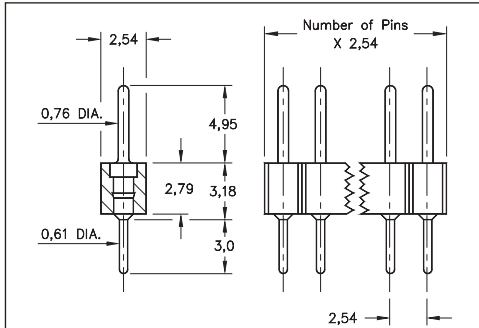

FIG. 1

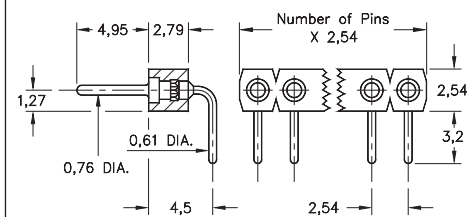

FIG. 2

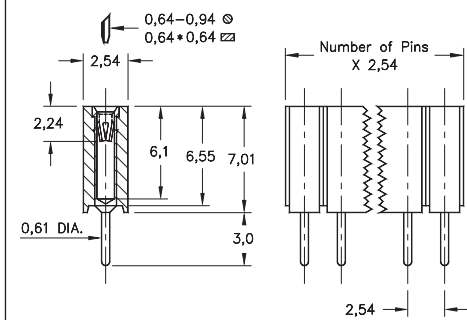

FIG. 3

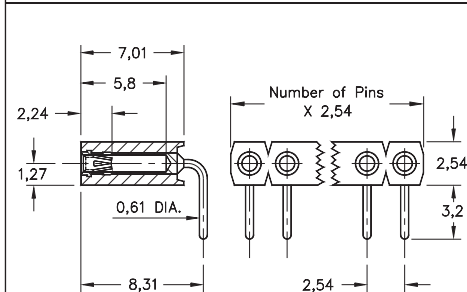
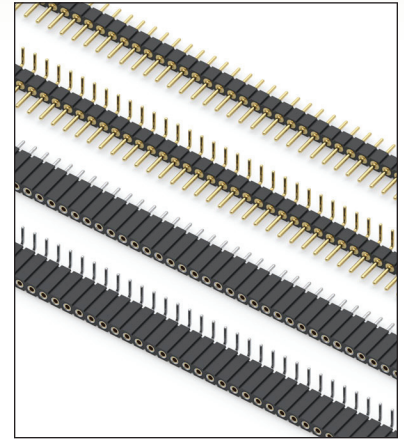

FIG. 4

- Pin interconnects available with straight MM #7007 or right angle MM #5005 solder tails. See page 215 for details
- Sockets are available with straight MM #1304 or right angle MM #1305 soldertails. See pages 177 and 179 for details
- MM #1304 and MM #1305 receptacles use Hi-Rel, 6-finger BeCu #47 contact rated at 4.5 amps. Receptacles accept 0,76 diameter and 0,64 square pins. See page 256 for details
- Insulators are high temperature thermoplastic, suitable for all soldering operations



ORDERING INFORMATION

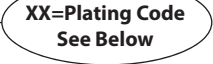



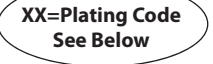





FIG. 1	Series 800...10-001		Straight Pin Header	
		800-XX-0	-10-001000	
	Specify number of pins		01-64	
FIG. 2	Series 800...20-001		Right Angle Pin Header	
		800-XX-0	-20-001000	
	Specify number of pins		02-64	
 XX=Plating Code See Below For Electrical, Mechanical & Environmental Data, See page 264				
SPECIFY PLATING CODE XX=		10 	90	40 
Pin Plating 		0,25µm Au	5,08µm Sn/Pb	5,08µm Sn

FIG. 3	Series 801...10-001		Straight Socket					
		801-XX-0	-10-001000					
	Specify number of pins		01-50					
FIG. 4	Series 801...20-001		Right Angle Socket					
		801-XX-0	-20-001000					
	Specify number of pins		01-50					
 XX=Plating Code See Below For Electrical, Mechanical & Environmental Data, See page 264								
SPECIFY PLATING CODE XX=		91	93	99	41 	43 	44 	47 
Sleeve (Pin) 		5,08µm Sn/Pb	5,08µm Sn/Pb	5,08µm Sn/Pb	5,08µm Sn	5,08µm Sn	5,08µm Sn	
Contact (Clip) 		0,25µm Au	0,76µm Au	2,54µm Sn/Pb	0,25µm Au	0,76µm Au	2,54µm Sn	Au Flash

★ 44 Plating Non-Standard



X-ON Electronics

Largest Supplier of Electrical and Electronic Components

Click to view similar products for [Headers & Wire Housings](#) category:

Click to view products by [Mill-Max](#) manufacturer:

Other Similar products are found below :

[95000-104TRLF](#) [10135584-644402LF](#) [DF62W-EP2022PCA](#) [95000-106TRLF](#) [DF62W-2022SCA](#) [DF62W-EP2022PC](#) [2203348](#) [DF62W-2022SC](#) [1084018](#) [1029039](#) [1084017](#) [802-10-012-10-002000](#) [1112640](#) [1112639](#) [891-007-9SS-BST1T](#) [000-34000](#) [0008550134](#) [0009482033](#) [0009507031](#) [57102-F02-18ULF](#) [57102-S06-03LF](#) [57202-S52-04LF](#) [PCN6-15S-2.5E](#) [0039019024](#) [58102-G61-06LF](#) [582553-1](#) [0009485154](#) [0009508121](#) [0022285053](#) [0050291907](#) [018731A](#) [LY20-4P-DT1-P1E-BR](#) [02.125.8002.8](#) [60101931](#) [60598-1 \(Cut Strip\)](#) [M1625-3R/100](#) [61062-3](#) [61082-181009](#) [CSU011177004](#) [636-1427](#) [638009-1](#) [641938-9](#) [641991-4](#) [644168-1](#) [644827-2](#) [647662-1](#) [65039-019ELF](#) [65692-001LF](#) [65781-018](#) [65781-047](#)