

INTERCONNECTS

SERIES 800 & 801 • 2,54 GRID (0,76 DIA. PINS), STRAIGHT & RIGHT ANGLE HEADERS AND SOCKETS • SINGLE ROW STRIPS

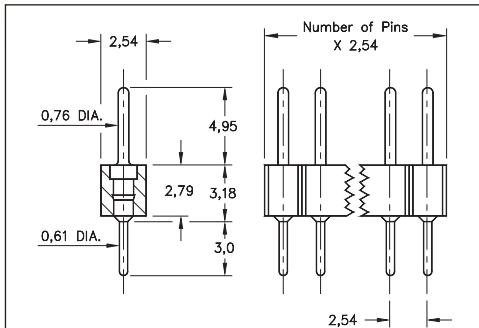

FIG. 1

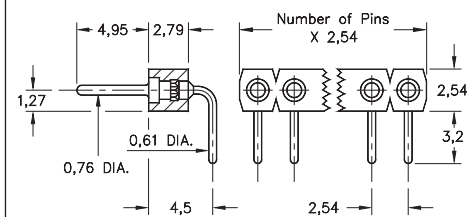

FIG. 2

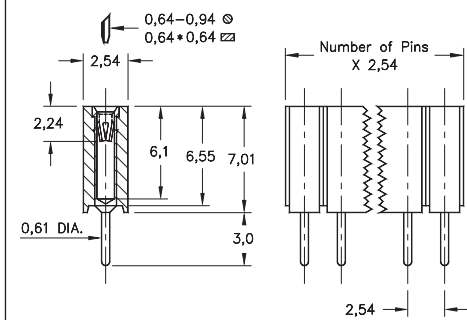

FIG. 3

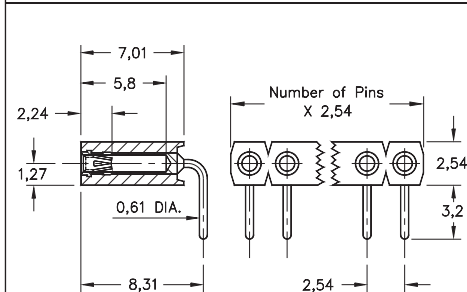

FIG. 4

• Pin interconnects available with straight MM #7007 or right angle MM #5005 solder tails. See page 215 for details

• Sockets are available with straight MM #1304 or right angle MM #1305 soldertails. See pages 177 and 179 for details

• MM #1304 and MM #1305 receptacles use Hi-Rel, 6-finger BeCu #47 contact rated at 4.5 amps. Receptacles accept 0,76 diameter and 0,64 square pins. See page 256 for details

• Insulators are high temperature thermoplastic, suitable for all soldering operations

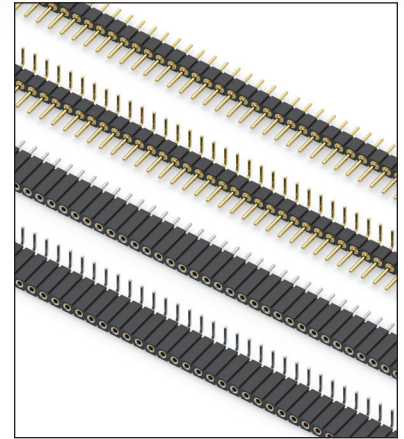

ORDERING INFORMATION

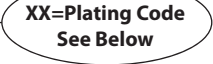





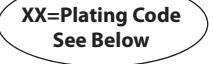
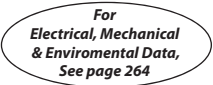



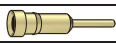

FIG. 1	Series 800...10-001		Straight Pin Header	
		800-XX-0	-10-001000	
	Specify number of pins		01-64	
FIG. 2	Series 800...20-001		Right Angle Pin Header	
		800-XX-0	-20-001000	
	Specify number of pins		02-64	
  				
SPECIFY PLATING CODE XX=		10 	90	40 
Pin Plating 		0,25µm Au	5,08µm Sn/Pb	5,08µm Sn

FIG. 3	Series 801...10-001		Straight Socket					
		801-XX-0	-10-001000					
	Specify number of pins		01-50					
FIG. 4	Series 801...20-001		Right Angle Socket					
		801-XX-0	-20-001000					
	Specify number of pins		01-50					
  								
SPECIFY PLATING CODE XX=		91	93	99	41 	43 	44 	47 
Sleeve (Pin) 		5,08µm Sn/Pb	5,08µm Sn/Pb	5,08µm Sn/Pb	5,08µm Sn	5,08µm Sn	5,08µm Sn	5,08µm Sn
Contact (Clip) 		0,25µm Au	0,76µm Au	2,54µm Sn/Pb	0,25µm Au	0,76µm Au	2,54µm Sn	Au Flash

★ 44 Plating Non-Standard



X-ON Electronics

Largest Supplier of Electrical and Electronic Components

Click to view similar products for [IC & Component Sockets](#) category:

Click to view products by [Mill-Max](#) manufacturer:

Other Similar products are found below :

[0066-3-17-15-30-14-02-0](#) [670](#) [672](#) [673](#) [694-13-640-00-672-000](#) [712-93-120-41-001000](#) [714-93-104-31-018000](#) [8059-4G1-LF](#) [807-22-001-10-001101](#) [807-22-001-10-006101](#) [807-22-001-30-011101](#) [807-22-001-30-012101](#) [807-22-001-30-013101](#) [807-22-001-30-014101](#) [8-1437531-4](#) [8150-6P10](#) [833-93-034-10-001000](#) [851-41-006-10-001000](#) [851-43-008-20-001000](#) [851-43-014-20-001000](#) [851-93-006-20-001000](#) [851-93-010-20-001000](#) [853-43-020-10-001000](#) [86.010.0053.0](#) [116-43-308-41-007000](#) [PX-68LCC](#) [121-13-318-41-001000](#) [121-13-320-41-001000](#) [121-13-308-41-001000](#) [123-43-314-41-801000](#) [123-43-420-41-001000](#) [123-87-320-41-001101](#) [122-13-316-41-001000](#) [123-13-624-41-001000](#) [123-43-306-41-001000](#) [12-3513-11](#) [123-91-320-41-001000](#) [126-43-310-41-002000](#) [AKSUN 37V-T](#) [1437503-9](#) [1437504-1](#) [146-44-308-41-013000](#) [APO-320-G-T](#) [146-43-308-41-012000](#) [160-10-308-00-001000](#) [160-40-320-00-001000](#) [214-99-306-01-670800](#) [232-1270-02-0602](#) [2-382761-4](#) [2-5331677-4](#)