

INTERCONNECTS

SERIES 350, 450, 801, 803 • .100" GRID (.025" DIA. PINS), LOW PROFILE HEADERS & VERSATILE SOCKETS • SINGLE & DOUBLE ROW STRIPS

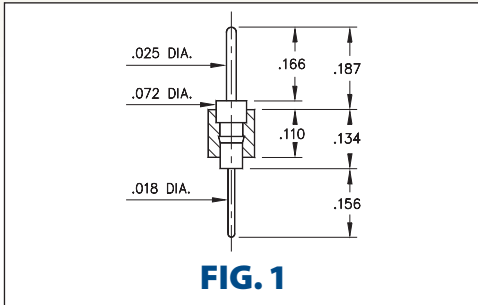

FIG. 1

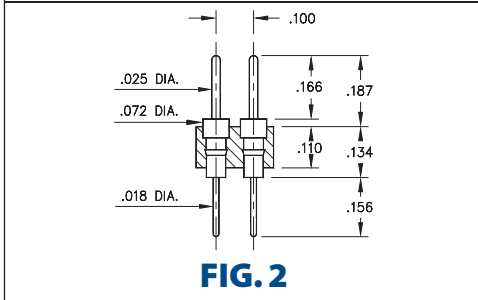

FIG. 2

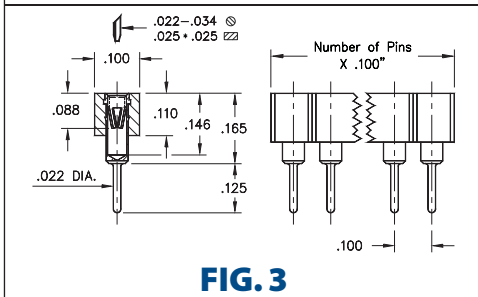

FIG. 3

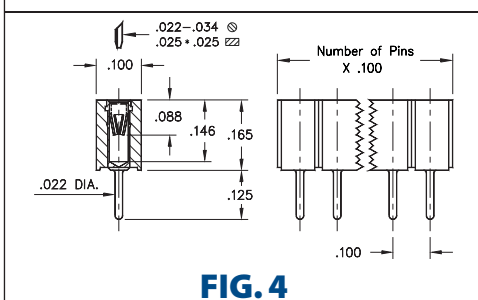

FIG. 4

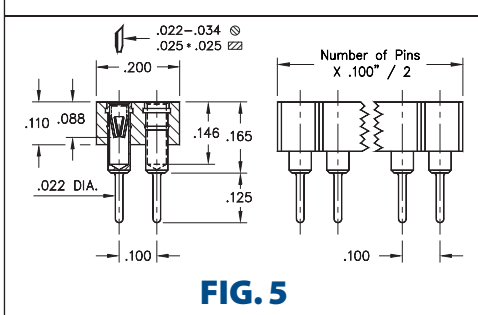

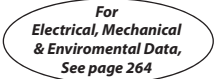









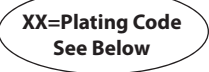















FIG. 5

- Series 350 and 450 single and double row pin headers use MM #0290 pins. See page 215 for details
- Series 801 and 803 single and double row low profile sockets use MM #1303 receptacles. See page 180 for details
- Series 801 and 803 receptacles use Hi-Rel, 6-finger BeCu #16 contact rated at 4.5 amps. Receptacles accept .025" diameter and .025" square pins. See page 256 for details
- Insulators are high temperature thermoplastic, suitable for all soldering operations



ORDERING INFORMATION

FIG. 1	Series 350...001 Single Row .025" Pin / .018" Solder Tail																					
	350-XX-1__-00-001000 Specify number of pins 01-64																					
FIG. 2	Series 450...001 Double Row .025" Pin / .018" Solder Tail																					
	450-XX-2__-00-001000 Specify number of pins 02-64																					
  																						
<table border="1" style="width: 100%; text-align: center;"> <tr> <td>SPECIFY PLATING CODE XX=</td> <td>10 </td> <td>90</td> <td>40 </td> <td></td> </tr> <tr> <td>Pin Plating </td> <td>10 μ" Au</td> <td>200 μ" Sn/Pb</td> <td>200 μ" Sn</td> <td></td> </tr> </table>		SPECIFY PLATING CODE XX=	10 	90	40 		Pin Plating 	10 μ" Au	200 μ" Sn/Pb	200 μ" Sn												
SPECIFY PLATING CODE XX=	10 	90	40 																			
Pin Plating 	10 μ" Au	200 μ" Sn/Pb	200 μ" Sn																			
FIG. 3	Series 801...003 Low Profile Socket (short insulator)																					
	801-XX-0__-10-003000 Specify number of pins 01-64																					
FIG. 4	Series 801...013 Low Profile Socket (long insulator)																					
	801-XX-0__-10-013000 Specify number of pins 01-36																					
FIG. 5	Series 803...003 Double Row Low Profile Socket																					
	803-XX-0__-10-003000 Specify number of pins 02-72																					
  																						
<table border="1" style="width: 100%; text-align: center;"> <tr> <td>SPECIFY PLATING CODE XX=</td> <td></td> <td></td> <td></td> <td>41 </td> <td>43 </td> <td></td> </tr> <tr> <td>Sleeve (Pin) </td> <td></td> <td></td> <td></td> <td>200 μ" Sn</td> <td>200 μ" Sn</td> <td></td> </tr> <tr> <td>Contact (Clip) </td> <td></td> <td></td> <td></td> <td>10 μ" Au</td> <td>30 μ" Au</td> <td></td> </tr> </table>		SPECIFY PLATING CODE XX=				41 	43 		Sleeve (Pin) 				200 μ" Sn	200 μ" Sn		Contact (Clip) 				10 μ" Au	30 μ" Au	
SPECIFY PLATING CODE XX=				41 	43 																	
Sleeve (Pin) 				200 μ" Sn	200 μ" Sn																	
Contact (Clip) 				10 μ" Au	30 μ" Au																	



X-ON Electronics

Largest Supplier of Electrical and Electronic Components

Click to view similar products for [Headers & Wire Housings](#) category:

Click to view products by [Mill-Max](#) manufacturer:

Other Similar products are found below :

[892-18-020-10-001101](#) [58102-G61-06LF](#) [582553-1](#) [0009485154](#) [009176003701906](#) [0050291907](#) [LY20-4P-DT1-P1E-BR](#) [02.125.8002.8](#)
[609-3404](#) [61062-3](#) [622-0430](#) [622-3653LF](#) [63453-116](#) [636-1030](#) [636-1427](#) [636-3427](#) [636-4007](#) [641938-9](#) [641991-4](#) [644827-2](#) [65817-010LF](#)
[65817-015LF](#) [65863-015LF](#) [66207-023LF](#) [67095-007LF](#) [67601157](#) [68648-049](#) [70.362.1628.0](#) [70-4210](#) [70-4226B](#) [70-4853B](#) [707-5020](#) [707-5028](#) [71.350.2428.0](#) [71918-208LF](#) [71961-016LF](#) [733-134](#) [733-162](#) [754199-000](#) [760-3052](#) [787-8014-00](#) [79531-3000](#) [FCN-360C032-B](#) [FCN-367T-T012/H](#) [FCN-723D010/2](#) [80.063.4001.1](#) [800-90-001-10-001000](#) [800-90-010-10-002000](#) [801-43-002-10-013000](#) [801-43-006-10-002000](#)