

INTERCONNECTS

SERIES 802 & 803 • .100" GRID (.030" DIA. PINS), STRAIGHT & RIGHT ANGLE HEADERS AND SOCKETS • DOUBLE ROW STRIPS

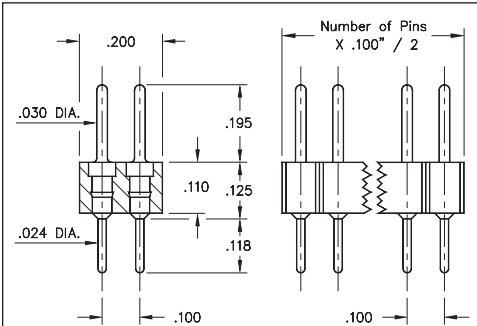

FIG. 1

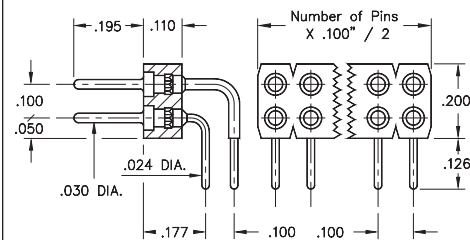

FIG. 2

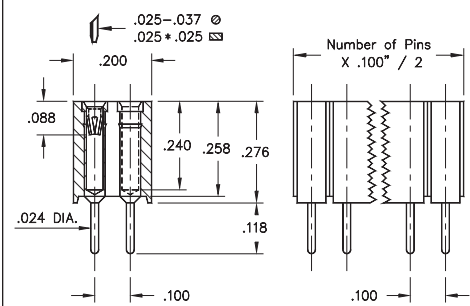

FIG. 3

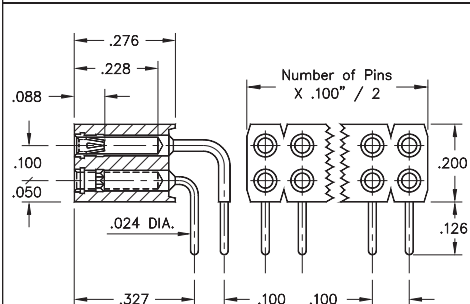
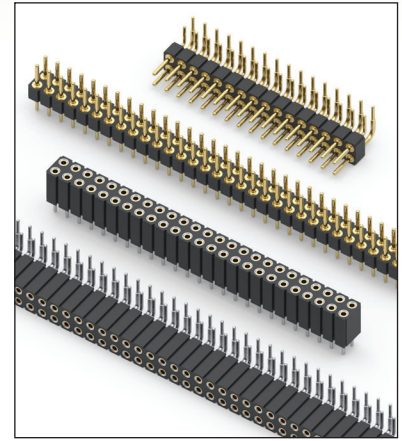

FIG. 4

- Pin interconnects available with straight MM #7007 or right angle MM #5005/5107 solder tails. See page 215 for details
- Sockets are available with straight MM #1304 or right angle MM #1305/1306 soldertails. See pages 177 and 179 for details
- MM #1304, #1305 and #1306 receptacles use Hi-Rel, 6-finger BeCu #47 contact rated at 4.5 amps. Receptacles accept .030" diameter and .025" square pins. See page 256 for details
- Insulators are high temperature thermoplastic, suitable for all soldering operations



ORDERING INFORMATION



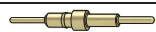



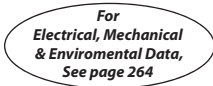





FIG. 1	Series 802...10-001	Straight Pin Header		
	802-XX-0	-10-001000	Specify number of pins 04-64	
FIG. 2	Series 802...20-001	Right Angle Pin Header		
	802-XX-0	-20-001000	Specify number of pins 02-64	
  				
SPECIFY PLATING CODE XX=				
Pin Plating 				
	10 	90	40 	
	10 μ" Au	200 μ" Sn/Pb	200 μ" Sn	

FIG. 3	Series 803...10-001	Straight Socket				
	803-XX-	-10-001000	Specify number of pins 004-100			
FIG. 4	Series 803...20-001	Right Angle Socket				
	803-XX-	-20-001000	Specify number of pins 002-100			
  						
SPECIFY PLATING CODE XX=						
Sleeve (Pin) 						
Contact (Clip) 						
	91	93	99	41 	43 	47 
	200 μ" Sn/Pb	200 μ" Sn/Pb	200 μ" Sn/Pb	200 μ" Sn	200 μ" Sn	200 μ" Sn
	10 μ" Au	30 μ" Au	100 μ" Sn/Pb	10 μ" Au	30 μ" Au	Au Flash



X-ON Electronics

Largest Supplier of Electrical and Electronic Components

Click to view similar products for [Headers & Wire Housings](#) category:

Click to view products by [Mill-Max](#) manufacturer:

Other Similar products are found below :

[892-18-020-10-001101](#) [58102-G61-06LF](#) [582553-1](#) [0009485154](#) [009176003701906](#) [0050291907](#) [LY20-4P-DT1-P1E-BR](#) [02.125.8002.8](#)
[609-3404](#) [61062-3](#) [61082-181009](#) [622-3653LF](#) [63453-116](#) [636-1030](#) [636-1427](#) [636-3427](#) [636-4007](#) [641938-9](#) [641991-4](#) [644827-2](#) [65817-](#)
[010LF](#) [65817-015LF](#) [65863-015LF](#) [66207-023LF](#) [67095-007LF](#) [67601157](#) [68648-049](#) [70.362.1628.0](#) [70-4210](#) [70-4226B](#) [70-4853B](#) [707-](#)
[5020](#) [707-5028](#) [71.350.2428.0](#) [71918-208LF](#) [71961-016LF](#) [733-134](#) [733-162](#) [754199-000](#) [760-3052](#) [787-8014-00](#) [79531-3000](#) [FCN-](#)
[360C032-B](#) [FCN-367T-T012/H](#) [FCN-723D010/2](#) [80.063.4001.1](#) [800-90-001-10-001000](#) [800-90-010-10-002000](#) [801-43-002-10-013000](#)
[801-43-006-10-002000](#)