

INTERCONNECTS

SERIES 830, 831, 832, 833 • 2mm GRID HEADERS AND SOCKETS • SINGLE AND DOUBLE ROW STRIPS

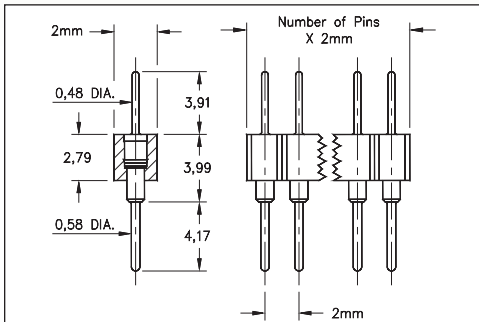

FIG. 1

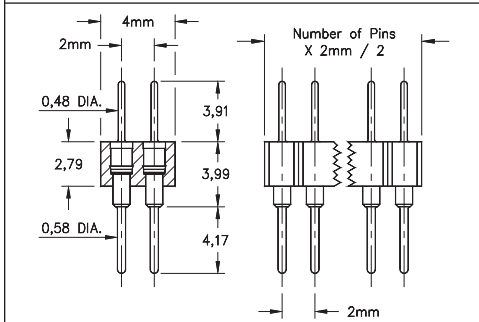

FIG. 2

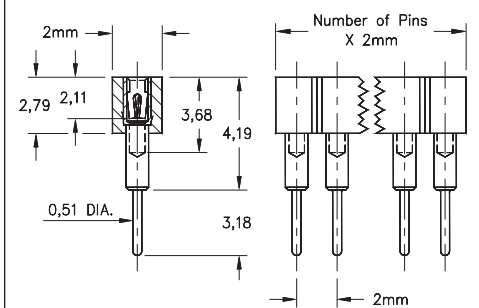

FIG. 3

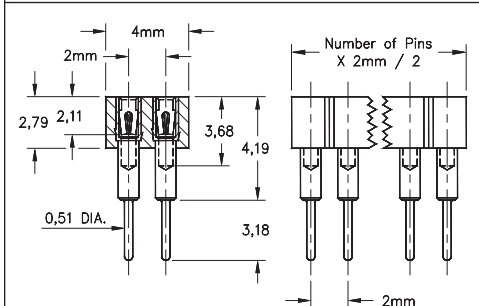

FIG. 4

- Series 830 single & double row interconnects have 2mm pin spacing and permit board stacking as low as 8,18
- Pin headers (830 & 832 series) use MM #5012 pins. See page 208 for details
- Sockets (831 & 833 series) use MM #1802 receptacles and accept pin diameters from 0,38 - 0,64. See page 169 for details
- Contact is rated at 3 amps
- Insulators are high temperature thermoplastic, suitable for all soldering operations



ORDERING INFORMATION









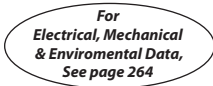



FIG. 1	Series 830...001	Single Row Pin Header		
	830-XX-0	-10-001000	Specify number of pins 01-50	
FIG. 2	Series 832...001	Double Row Pin Header		
	832-XX-	-10-001000	Specify number of pins 002-100	
  				
SPECIFY PLATING CODE XX=				
Pin Plating 				
	10 	90	40 	
	0,25µm Au	5,08µm Sn/Pb	5,08µm Sn	

FIG. 3	Series 831...001	Single Row Socket			
	831-XX-0	-10-001000	Specify number of pins 01-50		
FIG. 4	Series 833...001	Double Row Socket			
	833-XX-	-10-001000	Specify number of pins 002-100		
  					
SPECIFY PLATING CODE XX=					
Sleeve (Pin) 					
Contact (Clip) 					
	91	93	41 	43 	
	5,08µm Sn/Pb	5,08µm Sn/Pb	5,08µm Sn	5,08µm Sn	
	0,25µm Au	0,76µm Au	0,25µm Au	0,76µm Au	

X-ON Electronics

Largest Supplier of Electrical and Electronic Components

Click to view similar products for [Headers & Wire Housings](#) category:

Click to view products by [Mill-Max](#) manufacturer:

Other Similar products are found below :

[95000-104TRLF](#) [10135584-644402LF](#) [DF62W-EP2022PCA](#) [95000-106TRLF](#) [DF62W-2022SCA](#) [DF62W-EP2022PC](#) [2203348](#) [DF62W-2022SC](#) [1084018](#) [1029039](#) [1084017](#) [802-10-012-10-002000](#) [1112640](#) [1112639](#) [891-007-9SS-BST1T](#) [000-34000](#) [0008550134](#) [0009482033](#) [0009507031](#) [57102-F02-18ULF](#) [57102-S06-03LF](#) [57202-S52-04LF](#) [PCN6-15S-2.5E](#) [0039019024](#) [58102-G61-06LF](#) [582553-1](#) [0009485154](#) [0009508121](#) [0022285053](#) [0050291907](#) [018731A](#) [LY20-4P-DT1-P1E-BR](#) [02.125.8002.8](#) [60101931](#) [60598-1 \(Cut Strip\)](#) [M1625-3R/100](#) [61062-3](#) [61082-181009](#) [CSU011177004](#) [636-1427](#) [638009-1](#) [641938-9](#) [641991-4](#) [644168-1](#) [644827-2](#) [647662-1](#) [65039-019ELF](#) [65692-001LF](#) [65781-018](#) [65781-047](#)