

INTERCONNECTS

SERIES 830, 831, 832, 833 • 2mm GRID HEADERS AND SOCKETS • SINGLE AND DOUBLE ROW STRIPS

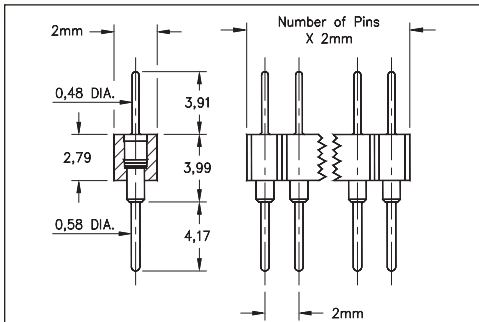

FIG. 1

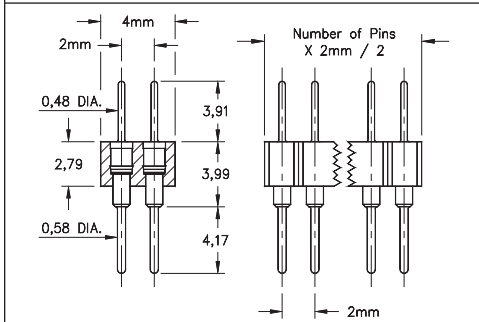

FIG. 2

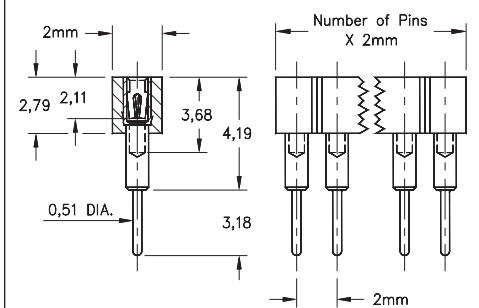

FIG. 3

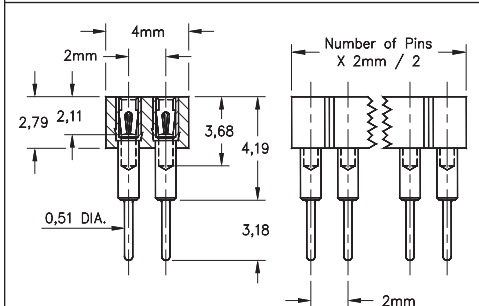
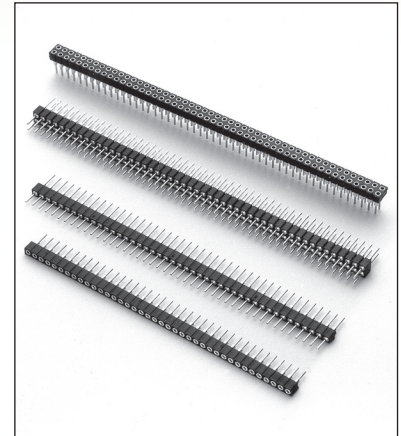

FIG. 4

- Series 830 single & double row interconnects have 2mm pin spacing and permit board stacking as low as 8,18
- Pin headers (830 & 832 series) use MM #5012 pins. See page 208 for details
- Sockets (831 & 833 series) use MM #1802 receptacles and accept pin diameters from 0,38 - 0,64. See page 169 for details
- Contact is rated at 3 amps
- Insulators are high temperature thermoplastic, suitable for all soldering operations



ORDERING INFORMATION









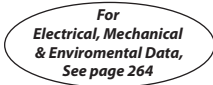



FIG. 1	Series 830...001	Single Row Pin Header		
	830-XX-0	-10-001000	Specify number of pins 01-50	
FIG. 2	Series 832...001	Double Row Pin Header		
	832-XX-	-10-001000	Specify number of pins 002-100	
  				
SPECIFY PLATING CODE XX=		10 	90	40 
Pin Plating 		0,25µm Au	5,08µm Sn/Pb	5,08µm Sn

FIG. 3	Series 831...001	Single Row Socket			
	831-XX-0	-10-001000	Specify number of pins 01-50		
FIG. 4	Series 833...001	Double Row Socket			
	833-XX-	-10-001000	Specify number of pins 002-100		
  					
SPECIFY PLATING CODE XX=		91	93	41 	43 
Sleeve (Pin) 		5,08µm Sn/Pb	5,08µm Sn/Pb	5,08µm Sn	5,08µm Sn
Contact (Clip) 		0,25µm Au	0,76µm Au	0,25µm Au	0,76µm Au

X-ON Electronics

Largest Supplier of Electrical and Electronic Components

Click to view similar products for [IC & Component Sockets](#) category:

Click to view products by [Mill-Max](#) manufacturer:

Other Similar products are found below :

[0066-3-17-15-30-14-02-0](#) [670](#) [672](#) [673](#) [694-13-640-00-672-000](#) [712-93-120-41-001000](#) [714-93-104-31-018000](#) [8059-4G1-LF](#) [807-22-001-10-001101](#) [807-22-001-10-006101](#) [807-22-001-30-011101](#) [807-22-001-30-012101](#) [807-22-001-30-013101](#) [807-22-001-30-014101](#) [8-1437531-4](#) [8150-6P10](#) [833-93-034-10-001000](#) [851-41-006-10-001000](#) [851-43-008-20-001000](#) [851-43-014-20-001000](#) [851-93-006-20-001000](#) [851-93-010-20-001000](#) [853-43-020-10-001000](#) [86.010.0053.0](#) [116-43-308-41-007000](#) [PX-68LCC](#) [121-13-318-41-001000](#) [121-13-320-41-001000](#) [121-13-308-41-001000](#) [123-43-314-41-801000](#) [123-43-420-41-001000](#) [123-87-320-41-001101](#) [122-13-316-41-001000](#) [123-13-624-41-001000](#) [123-43-306-41-001000](#) [12-3513-11](#) [123-91-320-41-001000](#) [126-43-310-41-002000](#) [AKSUN 37V-T](#) [1437503-9](#) [1437504-1](#) [146-44-308-41-013000](#) [APO-320-G-T](#) [146-43-308-41-012000](#) [160-10-308-00-001000](#) [160-40-320-00-001000](#) [214-99-306-01-670800](#) [232-1270-02-0602](#) [2-382761-4](#) [2-5331677-4](#)