

# INTERCONNECTS

## SERIES 850, 851, 852, 853 • 1,27 GRID RIGHT ANGLE HEADERS AND SOCKETS • SINGLE AND DOUBLE ROW STRIPS

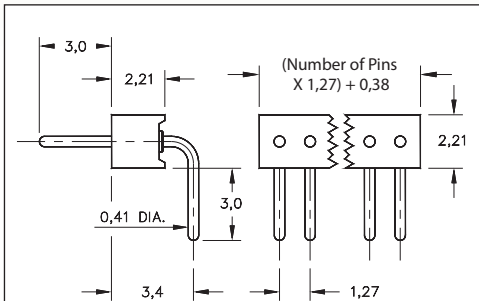

FIG. 1

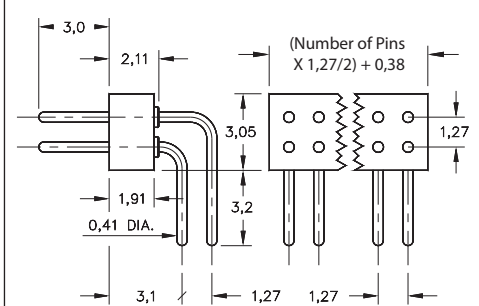

FIG. 2

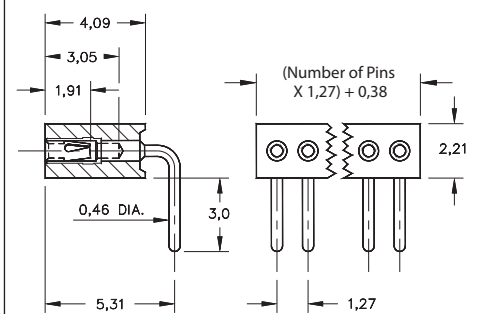

FIG. 3

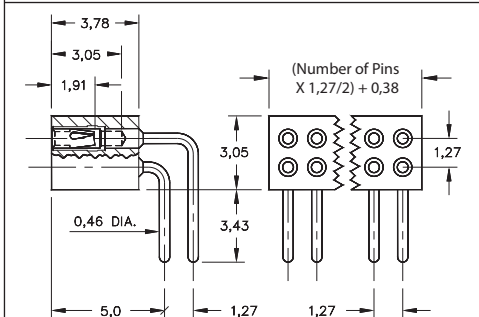
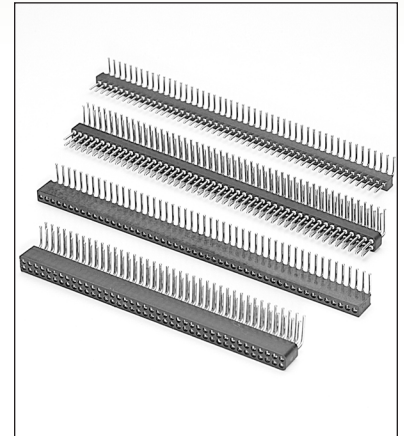

FIG. 4

- Series 850 and 851 interconnects are available in single and double row form
- Series 850 & 852 headers use MM #4006-1 and #4006-2 pins. See page 208 for details
- Series 851 & 853 sockets use MM #4890-1 and #4890-2 receptacles that accept pin diameters from 0,38 - 0,53. See page 160 for details
- Receptacles use Hi-Rel, 3-finger BeCu #11 contact rated at 3 amps. See page 251 for details
- Insulators are high temperature thermoplastic, suitable for all soldering operations



### ORDERING INFORMATION







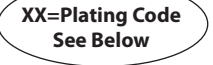
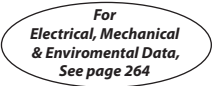



FIG. 1	Series 850...001	Single Row Right Angle Pin Header		
	850-XX-0	-20-001000	Specify number of pins 01-50	
FIG. 2	Series 852...001	Double Row Right Angle Pin Header		
	852-XX-	-20-001000	Specify number of pins 002-100	
  				
SPECIFY PLATING CODE XX=		10 	90	40 
Pin Plating 		0,25µm Au	5,08µm Sn/Pb	5,08µm Sn

FIG. 3	Series 851...001	Single Row Right Angle Socket			
	851-XX-0	-20-001000	Specify number of pins 01-50		
FIG. 4	Series 853...001	Double Row Right Angle Socket			
	853-XX-	-20-001000	Specify number of pins 002-100		
  					
SPECIFY PLATING CODE XX=			93	99	43 
Sleeve (Pin) 			5,08µm Sn/Pb	5,08µm Sn/Pb	5,08µm Sn
Contact (Clip) 			0,76µm Au	2,54µm Sn/Pb	0,76µm Au

## X-ON Electronics

Largest Supplier of Electrical and Electronic Components

*Click to view similar products for [Headers & Wire Housings](#) category:*

*Click to view products by [Mill-Max](#) manufacturer:*

Other Similar products are found below :

[892-18-020-10-001101](#) [58102-G61-06LF](#) [582553-1](#) [0009485154](#) [009176003701906](#) [0050291907](#) [LY20-4P-DT1-P1E-BR](#) [02.125.8002.8](#)  
[609-3404](#) [61062-3](#) [622-0430](#) [622-3653LF](#) [63453-116](#) [636-1030](#) [636-1427](#) [636-3427](#) [636-4007](#) [641938-9](#) [641991-4](#) [644827-2](#) [65817-010LF](#)  
[65817-015LF](#) [65863-015LF](#) [66207-023LF](#) [67095-007LF](#) [67601157](#) [68648-049](#) [70.362.1628.0](#) [70-4210](#) [70-4226B](#) [70-4853B](#) [707-5020](#) [707-5028](#) [71.350.2428.0](#) [71918-208LF](#) [71961-016LF](#) [733-134](#) [733-162](#) [754199-000](#) [760-3052](#) [787-8014-00](#) [79531-3000](#) [FCN-360C032-B](#) [FCN-367T-T012/H](#) [FCN-723D010/2](#) [80.063.4001.1](#) [800-90-001-10-001000](#) [800-90-010-10-002000](#) [801-43-002-10-013000](#) [801-43-006-10-002000](#)