

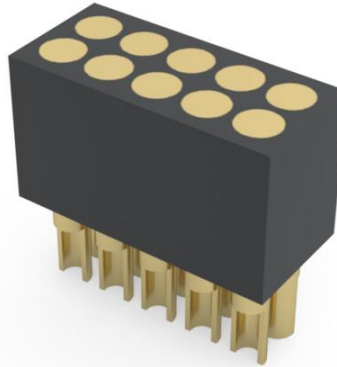

PRODUCT NUMBER: 857-10-010-10-003000

www.mill-max.com
DATA SHEET

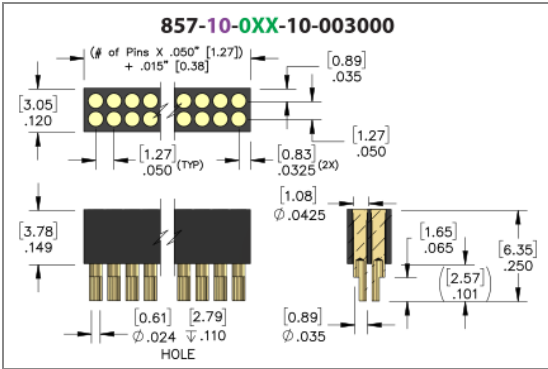

857-10-010-10-003000- SPECIFICATIONS

General Info	
Description¹:	Wire Termination Target Header Vertical Mount Soldercup Target; Flat Face
Type:	Spring-Loaded
Category:	Target Connector with Flat Face
Mounting Style:	Wire Termination - Soldercup
# Pins:	10
Pitch:	.050" (1,270mm)
Rows:	Double Row
Product Lifecycle:	Active

Materials	
Loose Pin/Receptacle # (Material):	1932 (Brass Alloy)
Shell Plating:	10 μ " Gold over 100 μ " Nickel
Inner Plating:	
Insulator Material:	High Temp Thermoplastic

Electrical Specs	
Rated Voltage:	100 VRMS/150 VDC
Insulation Resistance:	10,000 M Ω min.
Dielectric Withstanding Voltage:	1,000 VRMS min.

Environmental Specs	
Temperature Range²:	-55/+125° C
Shock³:	No Elect. Discontinuity > 1 μ s @ 50g
Vibration³:	No Elect. Discontinuity > 1 μ s @ 10-2000HZ, 15 G
RoHS⁴:	Yes

NOTES:

1. Standard Tolerances

Assembly tolerance: +/- .010" (.25mm)

Connector Length "L"

Connector Length "L"	Tolerance
$L \leq 2"$ ($L \leq 50.8$ mm)	+/- .005" (+/- .127 mm)
$2 < L \leq 3"$ ($50.8 < L \leq 76.2$ mm)	+ .007 / - .006" (+ .178 / - .152 mm)
$3 < L \leq 4"$ ($76.2 < L \leq 101.6$ mm)	+ .009 / - .007" (+ .229 / - .178 mm)
$4 < L \leq 5"$ ($101.6 < L \leq 127$ mm)	+ .011 / - .008" (+ .279 / - .203 mm)
$5 < L \leq 6.4"$ ($127 < L \leq 162.56$ mm)	+ .013 / - .009" (+ .330 / - .229 mm)

Insulator width: +/- .005 (.13mm)

Insulator height: +/- .005 (.13mm)

Co-planarity of SMT connectors: .005" (.13mm) up to 1" (25.4mm) in connector length

Insulator Flatness: .005" (.13mm) up to 1" (25.4mm) in connector length

Pin Length: +/- .005 (.13mm)

Pin Diameter: +/- .002 (.051mm)

Pin Angle: +/- 2°

2. Per IEC 60512-11-(4,-9,-10,-12)
3. For discrete pin only. Per IEC 60512-6-3: Test 6c: Shock
4. Mill-Max products labeled with the RoHS symbol are compliant with all three ROHS Directives. All of our products previously described as RoHS (2002/95/EC) and RoHS-2 (2011/65/EC) are also compliant with RoHS-3 (2015/863/EU).

ADDITIONAL NOTES AND SPECIFICATIONS

In the interest of improved design, quality and performance, Mill-Max reserves the right to make changes in its specifications without prior notice. Specifications and tolerances are provided wherever possible. The tolerance on dimensions of critical to function features is typically held tighter than the stated standard tolerances, such as press-fits, holes and lengths affecting the coplanarity of SMT products. Due to the wide variety of interconnects Mill-Max offers, the specific tolerances vary from product to product. If you need information regarding the tolerance of a particular part, please contact Technical Services.

RELATED LINKS AND DOCUMENTS

Engineering Notebook: (<https://www.mill-max.com/engineering-notebooks/machined-pin-pcb-connectors-interconnects>)

Environmental Compliance: (<https://www.mill-max.com/rohs>)

X-ON Electronics

Largest Supplier of Electrical and Electronic Components

Click to view similar products for [Headers & Wire Housings](#) category:

Click to view products by [Mill-Max](#) manufacturer:

Other Similar products are found below :

[892-18-020-10-001101](#) [0010894062](#) [0010977306](#) [0015477636](#) [0015917161](#) [0022104068](#) [0022121042](#) [0022155065](#) [0022281023](#) [57102-F02-18ULF](#) [58102-G61-06LF](#) [582553-1](#) [0015911208](#) [01.001.5753.1](#) [0022285048](#) [0050291907](#) [02.125.8002.8](#) [CSU011177004](#) [622-0430](#) [622-3653LF](#) [63453-116](#) [636-1030](#) [636-1427](#) [636-3427](#) [636-4007](#) [641938-9](#) [65495-038](#) [65692-001LF](#) [65781-018](#) [65781-047](#) [65817-010LF](#) [65817-015LF](#) [67095-007LF](#) [67601157](#) [68631-112](#) [68645-018](#) [699319-000](#) [70.362.1628.0](#) [70-4210](#) [70-4226B](#) [70-4853B](#) [707-5028](#) [71.350.2428.0](#) [733-134](#) [733-162](#) [760-3052](#) [MHR-64-VUAL](#) [80.063.4001.1](#) [800-90-001-10-001000](#) [801-43-002-10-013000](#)