



MD51XX is a highly accurate low dropout voltage regulator (LDO) manufactured in CMOS processes. It can deliver up to 300mA of current while consuming only 0.5uA of quiescent current. It consists of a reference voltage generator, an error amplifier, a current foldback circuit, and a phase compensation circuit plus a driver transistor.

#### ■ FEATURES:

- Ultra-low Quiescent Current: 500nA
- Highly Accurate:  $\pm 2\%$
- Dropout Voltage: 60mV@ $I_{OUT}=100mA$
- Maximum Output Current: 300mA
- Input Voltage Range: 1.4V~7.0V
- Temperature Stability:  $\pm 50ppm/^{\circ}C$
- ON/OFF Logic = Enable High
- Standby Current: 10nA
- $C_{OUT}$  Discharge Circuit when EN Disable is Active
- Protections Circuits: Current Limiter, Short Circuit, Foldback
- Output Capacitor: Low ESR Ceramic Capacitor Compatible

#### ■ APPLICATIONS:

- Smart wearer
- Long-life battery-powered devices
- Portable mobile devices, such as mobile phones, cameras, and so on
- Wireless communication equipment

#### ■ Product Selections:

Type	Output Voltage (note 1*)	Current Limit	Accuracy	Package (note 2*)	MARKING (note 3*)
MD5112	1.2V	470mA	$\pm 2\%$	DFNWB-4L\SOT89-3L\SOT23-5L\SOT23-3L	112\  5112
MD5115	1.5V	470mA	$\pm 2\%$	DFNWB-4L\SOT89-3L\SOT23-5L\SOT23-3L	115\  5115
MD5118	1.8V	470mA	$\pm 2\%$	DFNWB-4L\SOT89-3L\SOT23-5L\SOT23-3L	118\  5118
MD5121	2.1V	470mA	$\pm 2\%$	DFNWB-4L\SOT89-3L\SOT23-5L\SOT23-3L	121\  5121
MD5125	2.5V	470mA	$\pm 2\%$	DFNWB-4L\SOT89-3L\SOT23-5L\SOT23-3L	125\  5125
MD5128	2.8V	470mA	$\pm 2\%$	DFNWB-4L\SOT89-3L\SOT23-5L\SOT23-3L	128\  5128
MD5130	3.0V	470mA	$\pm 2\%$	DFNWB-4L\SOT89-3L\SOT23-5L\SOT23-3L	130\  5130
MD5133	3.3V	470mA	$\pm 2\%$	DFNWB-4L\SOT89-3L\SOT23-5L\SOT23-3L	133\  5133
MD5136	3.6V	470mA	$\pm 2\%$	DFNWB-4L\SOT89-3L\SOT23-5L\SOT23-3L	136\  5136
MD5140	4.0V	470mA	$\pm 2\%$	DFNWB-4L\SOT89-3L\SOT23-5L\SOT23-3L	140\  5140
MD5150	5.0V	470mA	$\pm 2\%$	DFNWB-4L\SOT89-3L\SOT23-5L\SOT23-3L	150\  5150

#### Notes:

1\* Customer can request to customize the output voltage ranged from 1.2V to 5V if desired voltage is not found in the selections.

2\* Customer can request customization of package choice.

3\* Please pay attention to the MARKING of the product package type.

## ■ PIN CONFIGURATION(TOP VIEW):

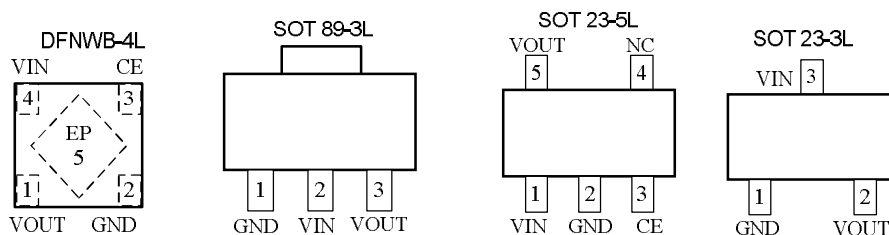

## ■ Absolute Maximum Ratings: (Unless otherwise indicated: $T_a=25^\circ\text{C}$ )

PARAMETER	SYMBOL	RATINGS	UNITS
Input Voltage	$V_{IN}$	-0.3 ~ 8.0	V
Output Voltage	$V_{OUT}$	-0.3 ~ $V_{IN}+0.3V$	
Power Dissipation	$P_D$	DFNWB-4L 100 SOT23-3L 250 SOT23-5L 250 SOT89-3L 500	mW
Operating Ambient Temperature	$T_{opr}$	-40 ~ +85	°C
Storage Temperature	$T_{stg}$	-40 ~ +125	
ESD Protection	ESD HBM	6000	V

Note: Stresses above those listed under "Absolute Maximum Ratings" may cause permanent damage to the device.

## ■ ELECTRICAL CHARACTERISTICS:

MD51XX Series

(Unless otherwise indicated:  $T_a=25^\circ\text{C}$ )

PARAMETER	SYMBOL	CONDITIONS	MIN.	TYP.	MAX.	UNIT
Output Voltage <sup>*1</sup>	$V_{OUT(S)}$	$V_{IN}=V_{OUT(S)}+2.0V$ $I_{OUT}=10mA, V_{OUT(S)}<2.0V$	$V_{OUT(S)}-0.03$	$V_{OUT(S)}$	$V_{OUT(S)}+0.03$	V
		$V_{IN}=V_{OUT(S)}+1.0V$ $I_{OUT}=10mA, V_{OUT(S)}\geq 2.0V$	$V_{OUT(S)}\times 0.98$		$V_{OUT(S)}\times 1.02$	
Dropout Voltage <sup>*2</sup>	$V_{DROP}$	$V_{CE}=V_{IN}, V_{OUT}<3V$ $I_{OUT}=100mA$		70		mV
		$V_{CE}=V_{IN}, V_{OUT}\geq 3V$ $I_{OUT}=100mA$		60		
Line Regulation	$\frac{\Delta V_{OUT}}{\Delta V_{IN} \cdot V_{OUT(S)}}$	$V_{OUT(S)}+0.5V \leq V_{IN}=V_{CE} \leq 7V$ $I_{OUT}=10mA$		0.05	0.1	%/V
Load Regulation	$\Delta V_{OUT2}$	$V_{IN}=V_{CE}=V_{OUT(S)}+1.0V$ $1mA \leq I_{OUT} \leq 100mA$		6	20	mV
Temperature Stability	$\frac{\Delta V_{OUT}}{\Delta T_a \cdot V_{OUT(S)}}$	$V_{IN}=V_{CE}=V_{OUT(S)}+1.0V$ $I_{OUT}=1mA$ $-40^\circ\text{C} \leq T_a \leq 85^\circ\text{C}$		$\pm 50$		ppm/°C
GND Current (CE= $V_{IN}$ )	$I_{GND}$	no load		0.5	0.9	$\mu\text{A}$
		$I_{OUT}=100mA$		40		$\mu\text{A}$
Shutdown Current (CE=0)	$I_{SHUT}$	$V_{IN}=7.0V, V_{CE}=0$		0.01	0.1	$\mu\text{A}$
Input Voltage	$V_{IN}$	---	1.5		7	V
Maximum Output Current	$I_{OUTMAX}$		250	300		mA
Current Limit <sup>*2</sup>	$I_{LIM}$	$V_{IN}=V_{CE}=V_{OUT(S)}+1.0V$ $V_{OUT} = 0.95 \times V_{OUT(S)}$	300	470		mA
Short Circuit Current	$I_{SHORT}$	$V_{IN}=V_{CE}=V_{OUT(S)}+1.0V$ $V_{OUT}=0V$		65		mA
$C_{OUT}$ Auto Discharge	$R_{DCHG}$	$V_{CE}=0, V_{OUT}=V_{OUT(S)}$	280	450	640	$\Omega$
Power Supply Rejection Ratio	PSRR	$f=10\text{Hz}, V_{OUT(S)}=2.5V$		60		dB
		$f=100\text{Hz}, V_{OUT(S)}=2.5V$		45		
		$f=1\text{kHz}, V_{OUT(S)}=2.5V$		25		
CE 'H' Level Voltage	$V_{CEH}$	---	1.0		6.0	V

CE 'L' Level Voltage	$V_{CEL}$	---	0		0.38	
CE 'H' Level Current	$I_{CEH}$	$V_{IN}=6.0V, V_{CE}=V_{IN}$	-0.1		0.1	uA
CE 'L' Level Voltage	$I_{CEL}$	$V_{IN}=6.0V, V_{CE}=0$	-0.1		0.1	

Notes:

1.  $V_{OUT(S)}$ : Output voltage when  $V_{IN}=V_{OUT}+2V$ ,  $I_{OUT}=1$  mA.
2.  $V_{DROF}=V_{IN1} - (V_{OUT(S)} \times 0.98)$  where  $V_{IN1}$  is the input voltage when  $V_{OUT} = V_{OUT(S)} \times 0.98$ .
3.  $I_{LIM}$ : Output current when  $V_{IN}=V_{OUT(S)}+2V$  and  $V_{OUT} = 0.95 \times V_{OUT(S)}$ .

### ■ TYPICAL APPLICATIONS:

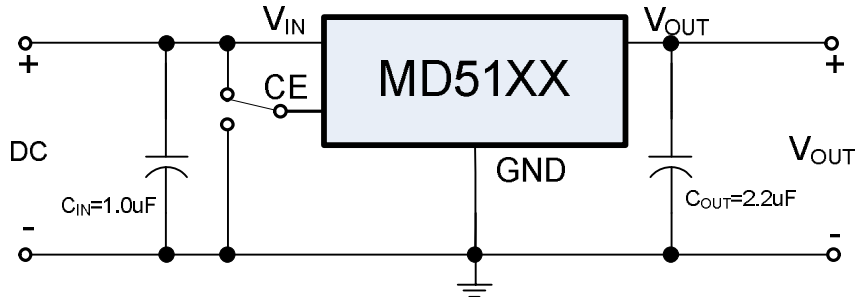

### ■ Notes on Use:

- Input Capacitor ( $C_{IN}$ ): 1.0 $\mu$ F above
- Output Capacitor ( $C_{OUT}$ ): 0.1 $\mu$ F above

■ **TYPICAL PERFORMANCE CHARACTERISTICS:**

Test Conditions:  $V_{IN}=V_{OUT}+1.0V$ ,  $C_{IN}=1.0\mu F$ ,  $C_{OUT}=0.1\mu F$  or  $1.0\mu F$ ,  $T_a=25^\circ C$ , unless otherwise indicated.

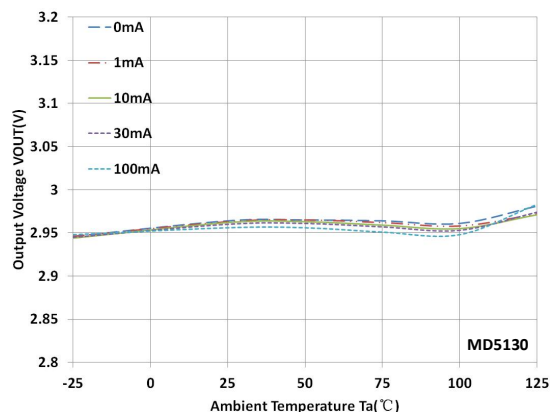

Output Voltage vs. Temperature  
( $C_{OUT}=0.1\mu F$ )

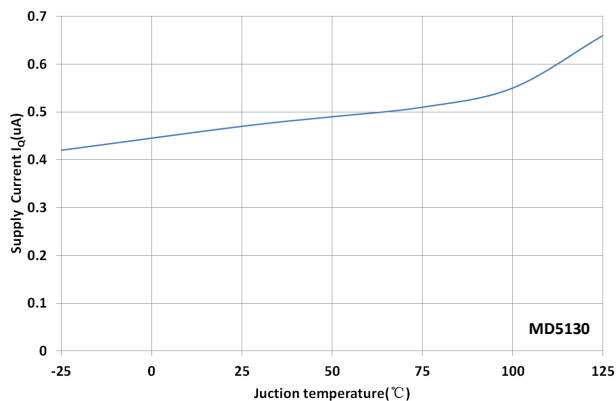

Supply Current vs. Temperature  
( $C_{OUT}=0.1\mu F$ )

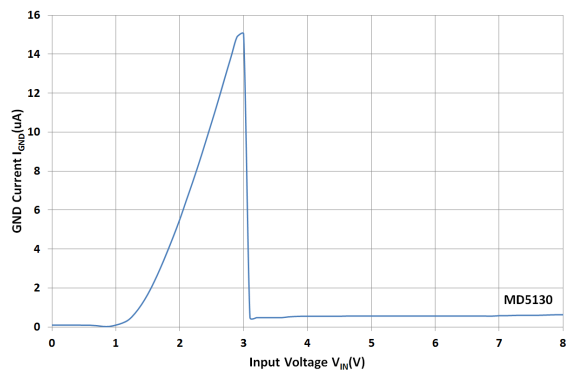

GND Current vs. Input Voltage  
( $C_{OUT}=0.1\mu F$ )

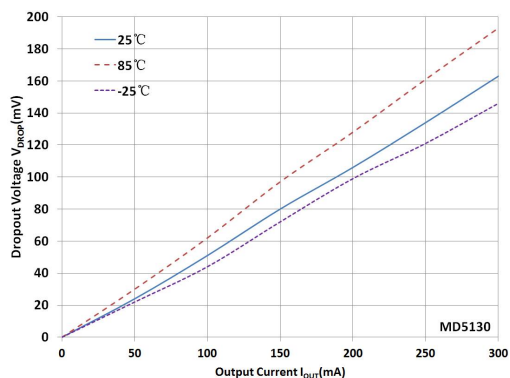

Dropout Voltage vs. Output Current  
( $C_{OUT}=0.1\mu F$ )

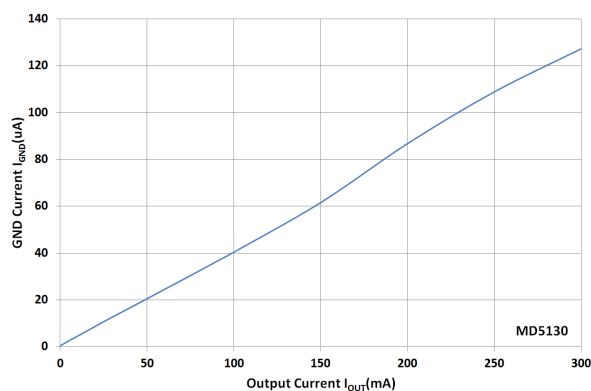

GND Current vs Output Current  
( $C_{OUT}=1.0\mu F$ )

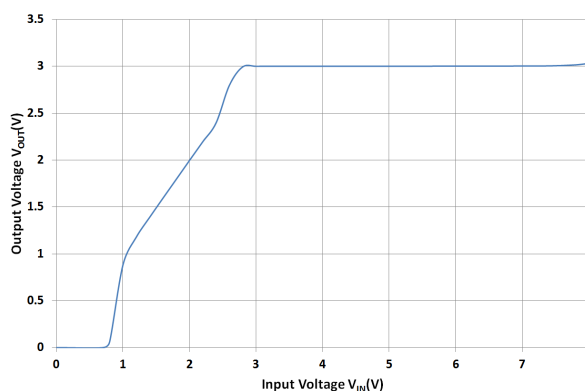

Output Voltage vs Input Voltage  
( $C_{OUT}=0.1\mu F$ )

■ **TYPICAL PERFORMANCE CHARACTERISTICS(CONTINUED):**

Test Conditions:  $V_{IN}=V_{OUT}+1.0V$ ,  $C_{IN}=1.0\mu F$ ,  $C_{OUT}=0.1\mu F$  or  $1.0\mu F$ ,  $T_a=25^\circ C$ , unless otherwise indicated.

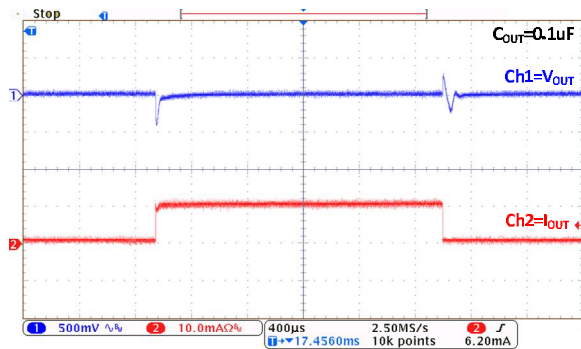

Load Transient:  
MD5130 ( $I_{OUT}=1mA\sim 10mA\sim 1mA$ )

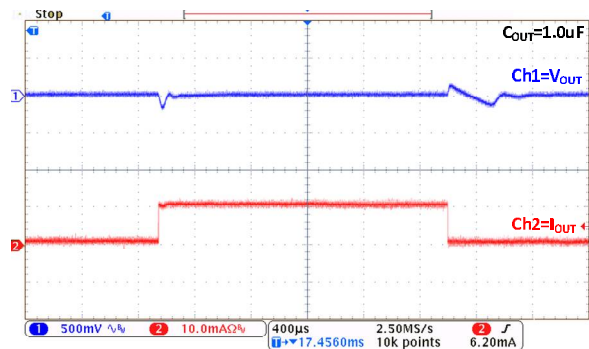

Load Transient:  
MD5130 ( $I_{OUT}=1mA\sim 10mA\sim 1mA$ )

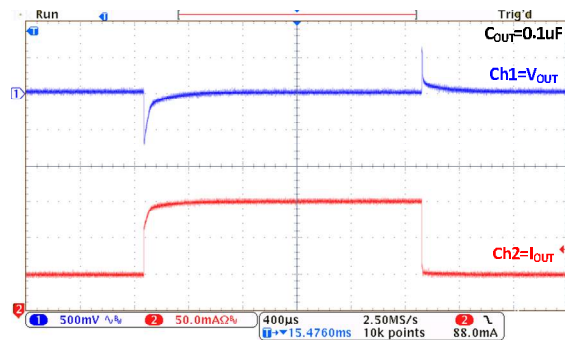

Load Transient:  
MD5130 ( $I_{OUT}=50mA\sim 100mA\sim 50mA$ )

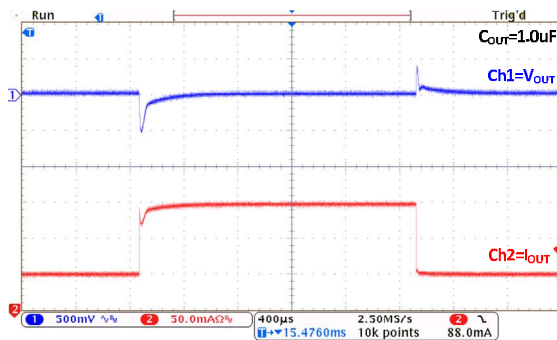

Load Transient:  
MD5130 ( $I_{OUT}=50mA\sim 100mA\sim 50mA$ )

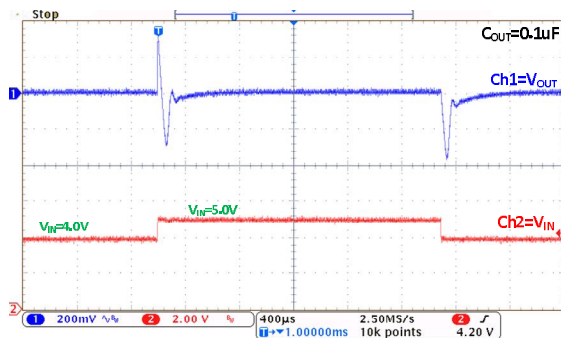

Line Transient:  
MD5130 ( $I_{OUT}=1mA$ )

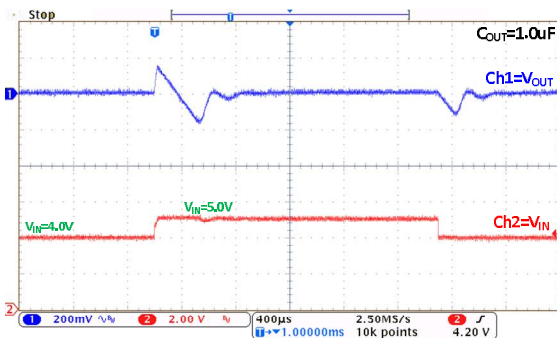

Line Transient:  
MD5130 ( $I_{OUT}=1mA$ )

■ **TYPICAL PERFORMANCE CHARACTERISTICS(CONTINUED):**

Test Conditions:  $V_{IN}=V_{OUT}+1.0V$ ,  $C_{IN}=1.0\mu F$ ,  $C_{OUT}=0.1\mu F$  or  $1.0\mu F$ ,  $T_a=25^\circ C$ , unless otherwise indicated.

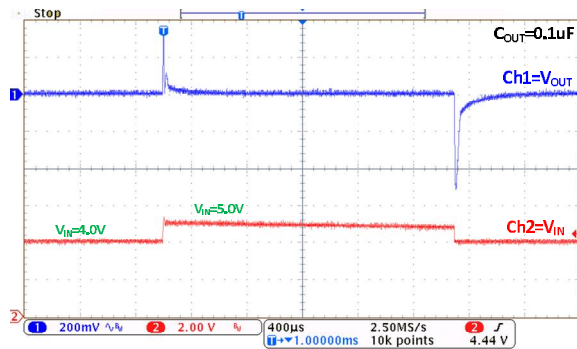

Line Transient:  
MD5130 ( $I_{OUT}=10mA$ )

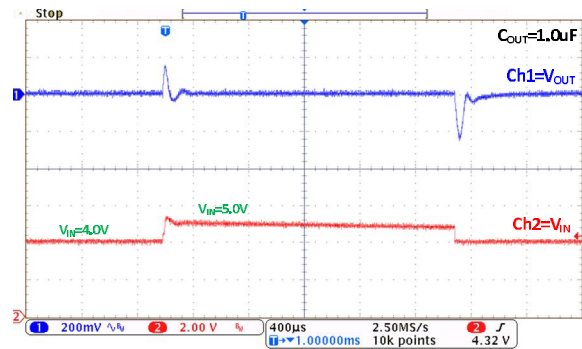

Line Transient:  
MD5130 ( $I_{OUT}=10mA$ )

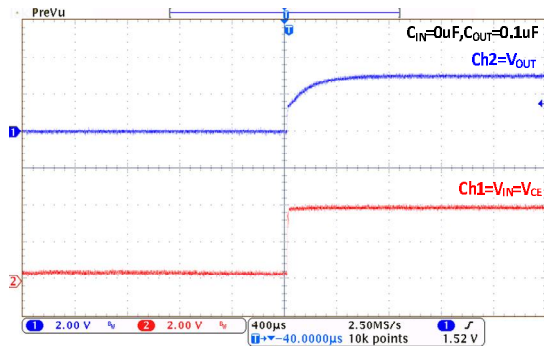

Power Up:  
MD5130 ( $I_{OUT}=1mA$ )

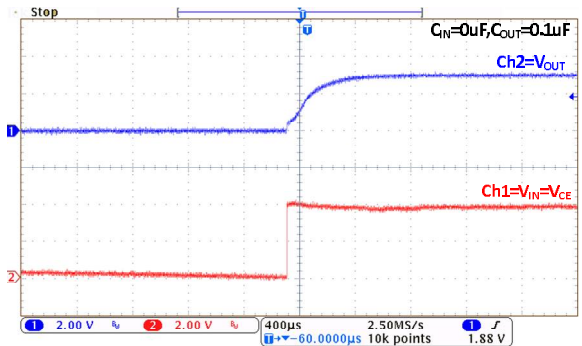

Power Up:  
MD5130 ( $I_{OUT}=100mA$ )

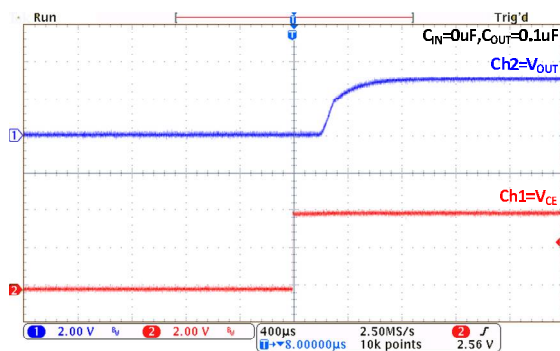

EN Enable:  
MD5130 ( $I_{OUT}=1mA$ )

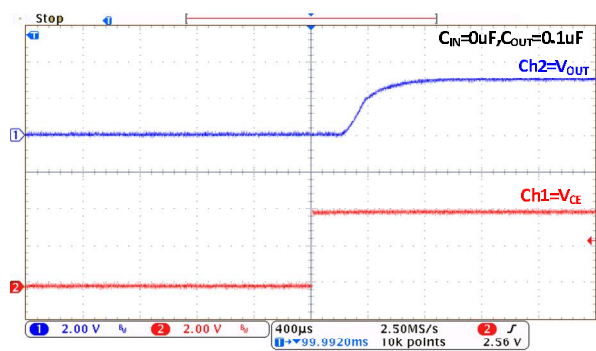

EN Enable:  
MD5130 ( $I_{OUT}=100mA$ )

## ■ TYPICAL PERFORMANCE CHARACTERISTICS(CONTINUED):

Test Conditions:  $V_{IN}=V_{OUT}+1.0V$ ,  $C_{IN}=1.0\mu F$ ,  $C_{OUT}=0.1\mu F$  or  $1.0\mu F$ ,  $T_a=25^\circ C$ , unless otherwise indicated.

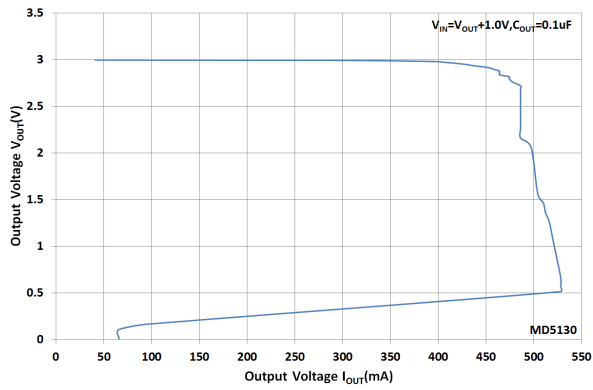

MD5130 Output Current Fold-back

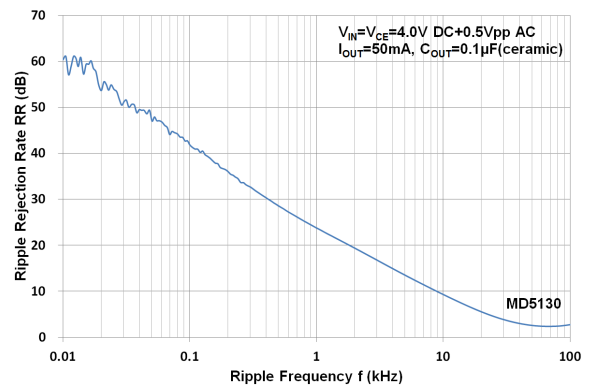

MD5130 Power Supply Rejection Ratio

## ■ OPERATIONAL EXPLANATION:

### 1. Output voltage control

The voltage divided by resistors R1 and R2 is compared with the internal reference voltage by the error amplifier. The amplifier output then drives the P-channel MOSFET connected to the  $V_{OUT}$  pin. The output voltage at the  $V_{OUT}$  pin is regulated by this negative feedback system. The current limit circuit and short protect circuit operate in relation to output current level. Further, the IC's internal circuitry can be in operation or shutdown modes controlled by the CE pin's signal.

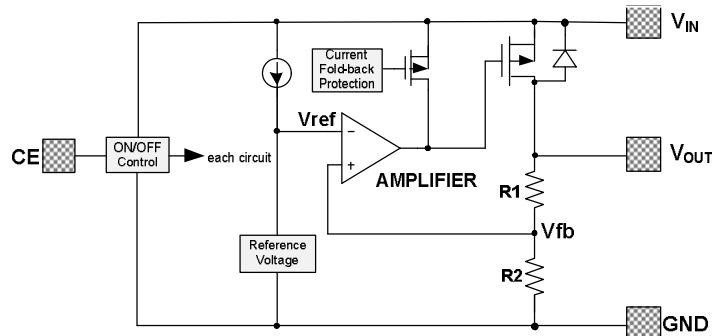

### 2. Pass transistor

The pass transistor with low turn-on resistance used in MD51XX is a P-channel MOSFET. If the potential on  $V_{OUT}$  pin is higher than  $V_{IN}$ , it is possible that IC will be destroyed due to reverse current which is caused by parasitic diodes between  $V_{IN}$  and  $V_{OUT}$ . Therefore, the  $V_{OUT}$  pin potential exceeds  $V_{IN}+0.3V$  is not allowed.

### 3. Current foldback and short circuit protection

The MD51XX series includes a combination of a fixed current limiter circuit and a foldback circuit, which aid the operations of the current limiter and circuit protection. When the load current reaches the current limit level, the fixed current limiter circuit operates and output voltage drops. As a result of this drop in output voltage, the foldback circuit operates, output voltage drops further and output current decreases. The short circuit current is about 65mA (typical value). This design can prevent the chip be damaged due to over temperature, moreover, the heat dissipation is limited by the package type.

Special attention should be paid to that the product of the dropout voltage on the chip and the output current must be smaller than the heat dissipation.

### 4. $C_{OUT}$ Auto-Discharge Function

The MD51XX series can quickly discharge the electric charge at the output capacitor ( $C_{OUT}$ ), when a low signal is set to the CE pin, which puts the whole IC into OFF state. The discharge function is achieved by an internal switch located between the  $V_{OUT}$  pin and the GND pin. In this state, the application is protected from a glitch operation caused by the electric charge at the output capacitor ( $C_{OUT}$ ).

Moreover, discharge time of the output capacitor ( $C_{OUT}$ ) is set by the  $C_{OUT}$  auto-discharge resistance ( $R_{DCHG}$ ) and the output capacitor ( $C_{OUT}$ ). By setting time constant of a  $C_{OUT}$  auto-discharge resistance value ( $R_{DCHG}$ ) and an output capacitor value ( $C_{OUT}$ ) as  $\tau$  ( $\tau = C_{OUT} \times R_{DCHG}$ ), the output voltage after discharge via the internal switch is calculated by the following formulas.

$$V = V_{OUT(S)} \times e^{-t/\tau} \text{ or } t = \tau \ln(V_{OUT(S)} / V)$$



V: Output voltage after discharge

$V_{OUT(S)}$ : Output voltage

t: Discharge time

$$\tau: C_{OUT} \times R_{DCHG}$$

Please also note  $R_{DCHG}$  is depended on  $V_{IN}$  and When  $V_{IN}$  is high,  $R_{DCHG}$  is low.

■ **Notes:**

1. The input and output capacitors should be placed as close as possible to the IC.
2. If the impedance of the power supply is high, which is caused by forgetting installing input capacitor or installing too small value capacitor, the oscillation may occur.
3. Pay attention to the operation conditions of input and output voltage and load current, such that the power consumption in the IC should not exceed the allowable power consumption of the package even though the chip has short circuit protection.
4. IC has a built-in anti-static protection (ESD) circuit, but please do not add excessive stress to the IC.

■ PACKAGING INFORMATION:

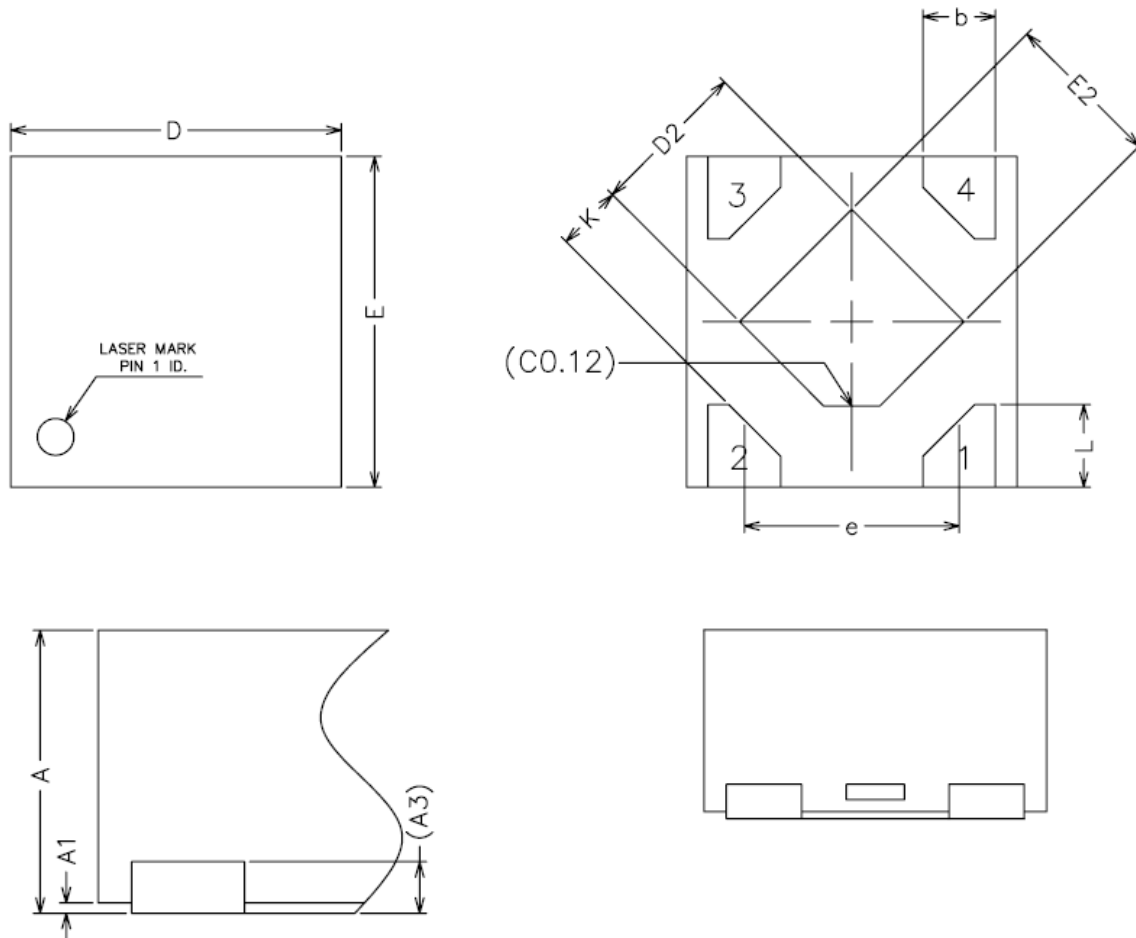

COMMON DIMENSIONS  
(UNITS OF MEASURE=MILLIMETER)

SYMBOL	MIN	NOM	MAX
A	0.50	0.55	0.60
A1	0.00	0.02	0.05
A3	0.100REF		
b	0.17	0.22	0.27
D	0.95	1.00	1.05
E	0.95	1.00	1.05
D2	0.43	0.48	0.53
E2	0.43	0.48	0.53
L	0.20	0.25	0.30
e	0.60	0.65	0.70
K	0.15	-	-

■ PACKAGING INFORMATION(Continued):

SOT-89-3L PACKAGE OUTLINE DIMENSIONS

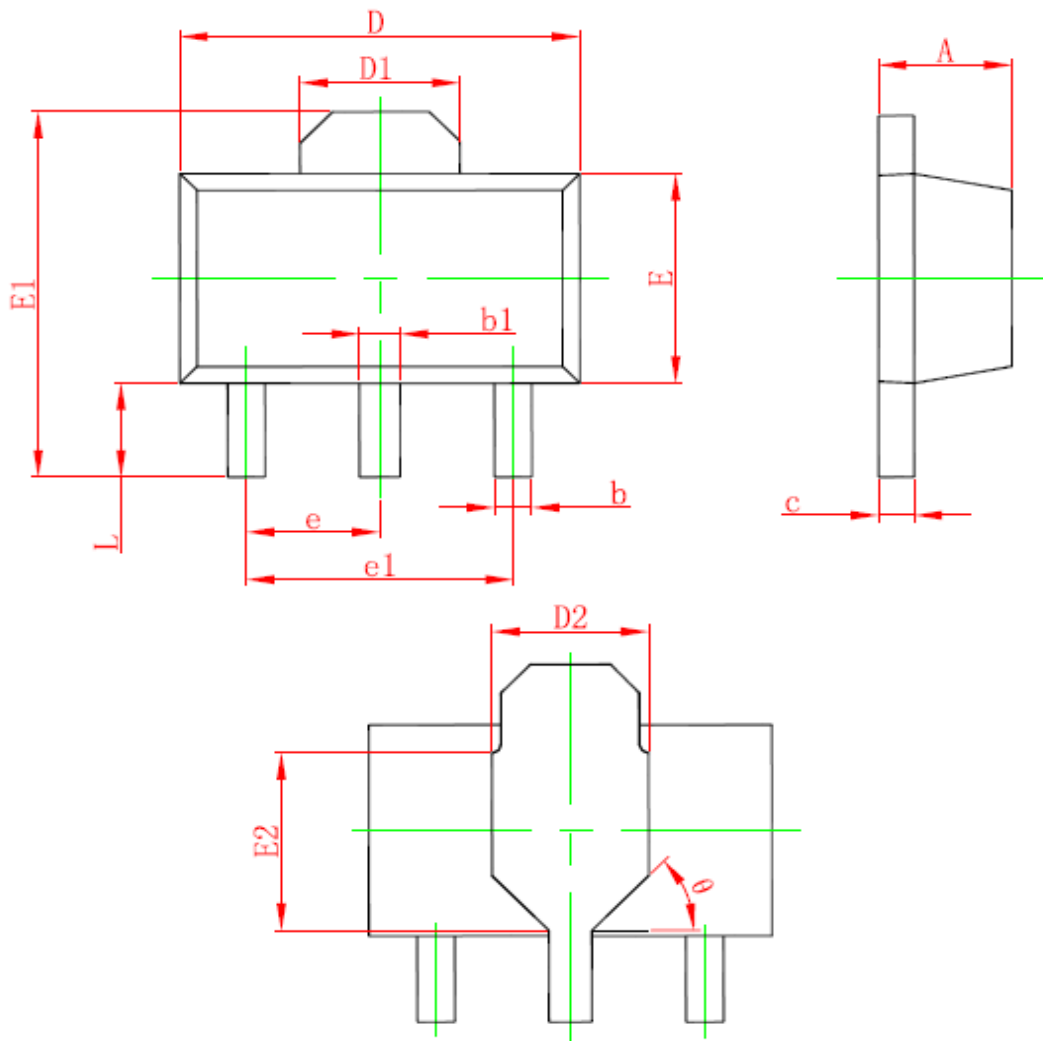

Symbol	Dimensions In Millimeters		Dimensions In Inches	
	Min.	Max.	Min.	Max.
A	1.400	1.600	0.055	0.063
b	0.320	0.520	0.013	0.020
b1	0.400	0.580	0.016	0.023
c	0.350	0.440	0.014	0.017
D	4.400	4.600	0.173	0.181
D1	1.550 REF.		0.061 REF.	
D2	1.750 REF.		0.069 REF.	
E	2.300	2.600	0.091	0.102
E1	3.940	4.250	0.155	0.167
E2	1.900 REF.		0.075 REF.	
e	1.500 TYP.		0.060 TYP.	
e1	3.000 TYP.		0.118 TYP.	
L	0.900	1.200	0.035	0.047
θ	45°		45°	

■ PACKAGING INFORMATION(Continued):

SOT-23-5L PACKAGE OUTLINE DIMENSIONS

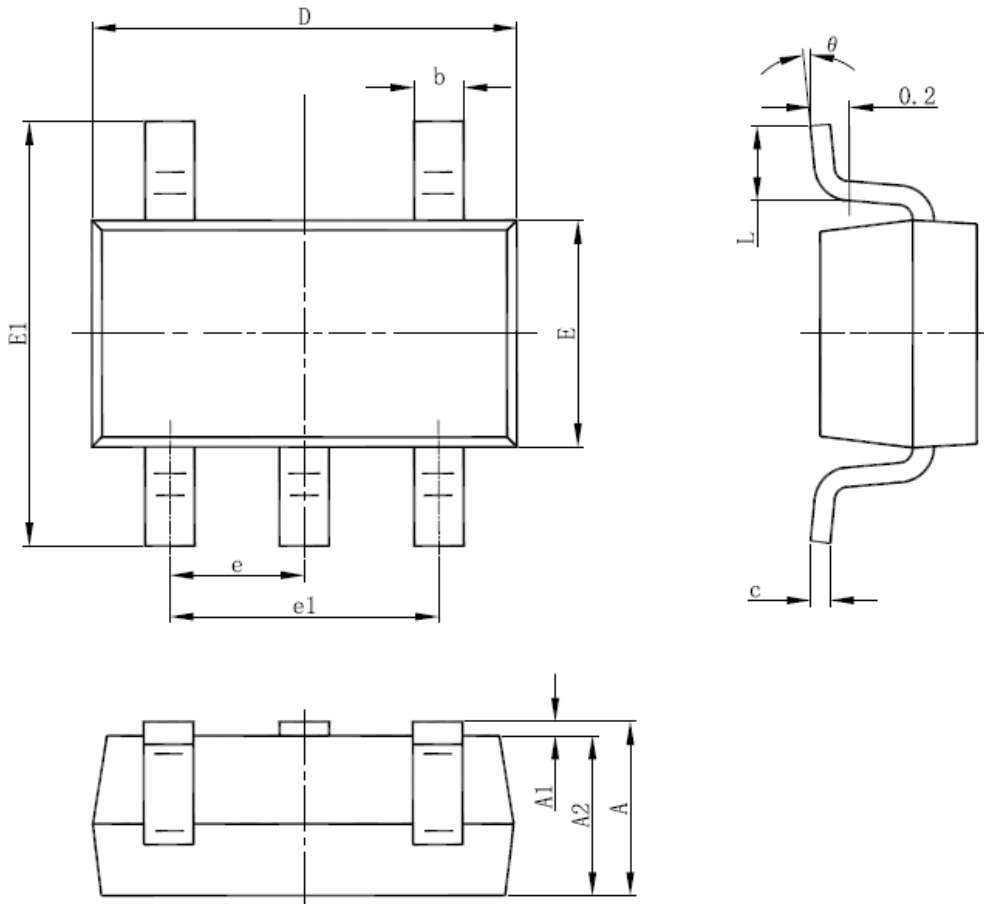

Symbol	Dimensions In Millimeters		Dimensions In Inches	
	Min	Max	Min	Max
A	1.050	1.250	0.041	0.049
A1	0.000	0.100	0.000	0.004
A2	1.050	1.150	0.041	0.045
b	0.300	0.500	0.012	0.020
c	0.100	0.200	0.004	0.008
D	2.820	3.020	0.111	0.119
E	1.500	1.700	0.059	0.067
E1	2.650	2.950	0.104	0.116
e	0.950(BSC)		0.037(BSC)	
e1	1.800	2.000	0.071	0.079
L	0.300	0.600	0.012	0.024
θ	0°	8°	0°	8°

■ PACKAGING INFORMATION(Continued):

SOT-23-3L PACKAGE OUTLINE DIMENSIONS

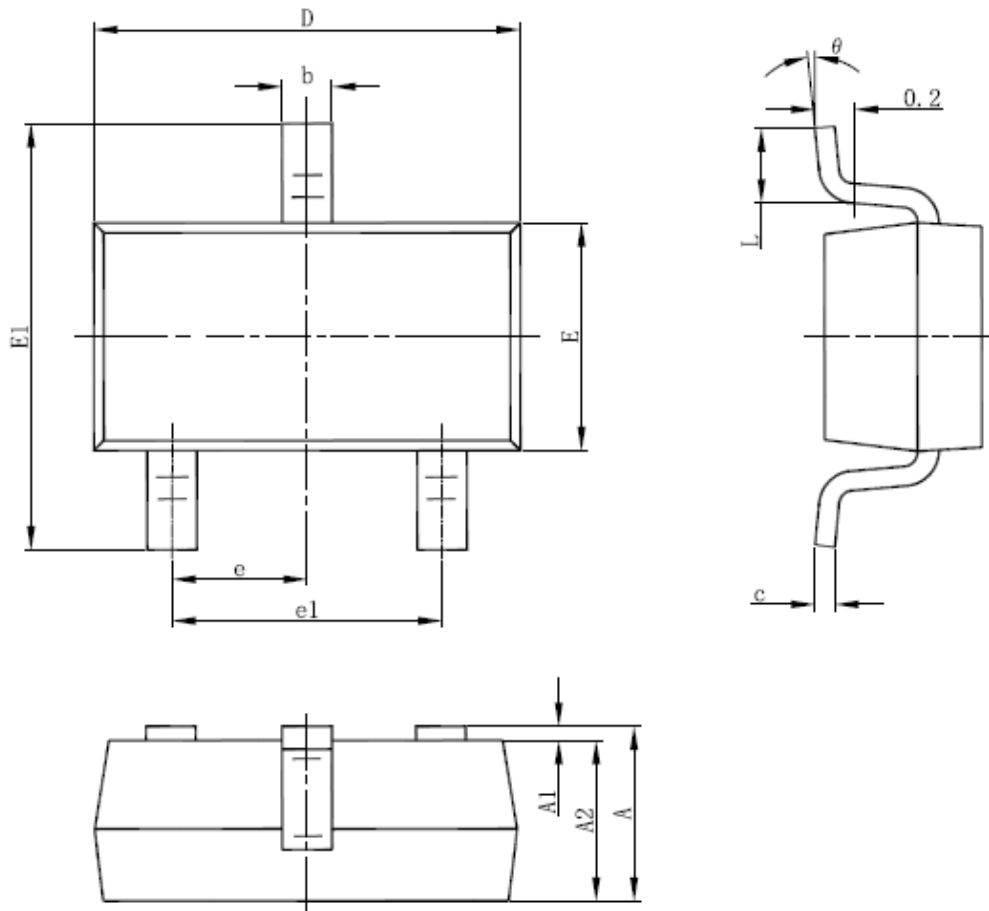

Symbol	Dimensions In Millimeters		Dimensions In Inches	
	Min	Max	Min	Max
A	1.050	1.250	0.041	0.049
A1	0.000	0.100	0.000	0.004
A2	1.050	1.150	0.041	0.045
b	0.300	0.500	0.012	0.020
c	0.100	0.200	0.004	0.008
D	2.820	3.020	0.111	0.119
E	1.500	1.700	0.059	0.067
E1	2.650	2.950	0.104	0.116
e	0.950(BSC)		0.037(BSC)	
e1	1.800	2.000	0.071	0.079
L	0.300	0.600	0.012	0.024
$\theta$	0°	8°	0°	8°

■ ORDER INFORMATION:

TYPE	PACKAGE	TEMPERATURE RANGE	
MD51XX	DFNWB-4L (1X1)	-40 to +85°C	10000 /Tape & Reel
	SOT89-3L	-40 to +85°C	1000/ Tape & Reel
	SOT23-5L	-40 to +85°C	3000/ Tape & Reel
	SOT23-3L	-40 to +85°C	3000/ Tape & Reel

For the newest datasheet, please see the website:

[www.md-ic.com.cn](http://www.md-ic.com.cn)

Version V1.1: 20190430

## X-ON Electronics

Largest Supplier of Electrical and Electronic Components

*Click to view similar products for [Linear Voltage Regulators](#) category:*

*Click to view products by [Mingda](#) manufacturer:*

Other Similar products are found below :

[LV56831P-E](#) [LV5684PVD-XH](#) [MCDTSA6-2R](#) [L7815ACV-DG](#) [PQ3DZ53U](#) [LV56801P-E](#) [TLE42794G](#) [L78L05CZ/1SX](#) [L78LR05DL-MA-E](#) [636416C](#) [714954EB](#) [BA033LBSG2-TR](#) [LV5680P-E](#) [L78M15CV-DG](#) [TLS202B1MBV33HTSA1](#) [L79M05T-E](#) [TLS202A1MBVHTSA1](#) [L78LR05D-MA-E](#) [NCV317MBTG](#) [NTE7227](#) [LV5680NPVC-XH](#) [LT1054CN8](#) [MP2018GZD-5-Z](#) [MP2018GZD-33-Z](#) [MIC5281-3.3YMM](#) [RT9078-28GQZ](#) [MC78L06BP-AP](#) [TA48LS05F\(TE85L,F\)](#) [TA78L12F\(TE12L,F\)](#) [TC47BR5003ECT](#) [TCR2LN12,LF\(S](#) [TCR2LN28,LF\(S](#) [TCR2LN30,LF\(S](#) [TCR3DF295,LM\(CT](#) [TCR3DF40,LM\(CT](#) [BA178M20CP-E2](#) [L78M12ABDT](#) [LM7812SX/NOPB](#) [LR645N3-G-P003](#) [LR645N3-G-P013](#) [ZXTR2005P5-13](#) [SCD7812BTG](#) [TCR3DF335,LM\(CT](#) [ZXTR2012K-13](#) [TLE42994E V33](#) [ZXTR2008K-13](#) [ZXTR2005K-13](#) [LA5693D-E](#) [L88R05DL-E](#) [ADP3300ARTZ-2.7RL7](#)