



MD7219 series is a high voltage (up to 18V) ultra-low quiescent current low dropout voltage regulator (LDO) manufactured in CMOS processes. It can deliver up to 1A of current while consuming 14uA of quiescent current. It consists of a reference voltage generator, an error amplifier, a current foldback circuit, and a phase compensation circuit plus a driver transistor. The MD7219 series is designed specifically for applications where very-low I_Q is a critical parameter. This

device maintains low quiescent current consumption even in dropout mode to further increase the battery life.

■ Features:

- Ultra-low Quiescent Current: 14uA
- Maximum Input Voltage: 18V
- Output Voltage Highly Accurate: $\pm 2\%$
- Maximum Output Current: 1A
- Dropout Voltage: 900mV@ $V_{OUT}=3.3V/1A$
- Temperature Stability: $\pm 50\text{ppm}/^\circ\text{C}$
- ON/OFF Logic = Enable High
- Protections Circuits: Current Limiter, Foldback, Thermal shutdown
- Output Capacitor: Low ESR Ceramic Capacitor Compatible

■ Applications:

- Smart wearer
- Long-life battery-powered devices
- Portable mobile devices, such as mobile phones, cameras, and so on
- Wireless communication equipment

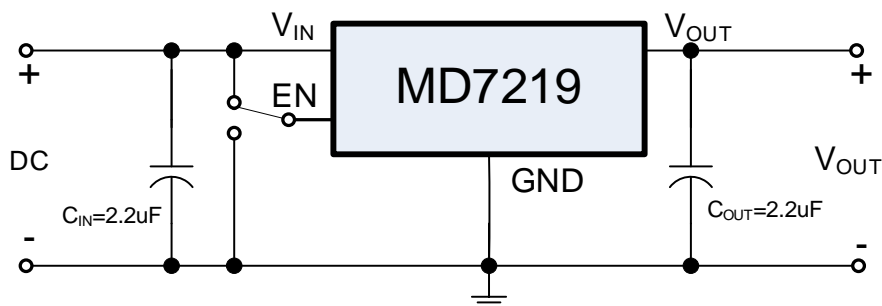
■ Typical Application:

■ Pin Configuration (Top View):

**SOT89-3L(A_Type)
Top View**

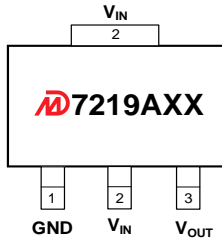

**SOT223-3L
Top View**

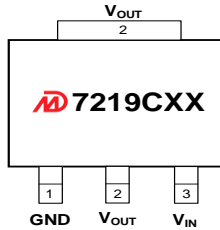

**TO252-2L
Top View**

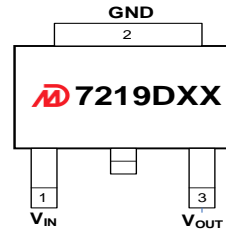

**ESOP8
Top View**

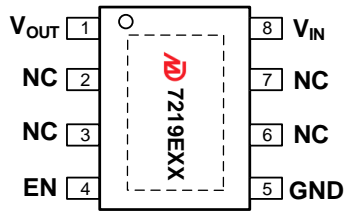

**SOT23-5L
Top View**



**SOT89-5L
Top View**

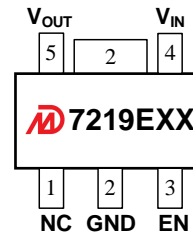



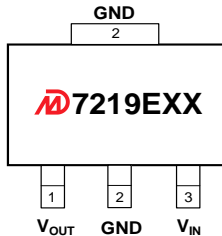













**SOT89-3L(E_Type)
Top View**



■ Product Selections

Product Name	V _{OUT} (V)	Package	Ordering Name	Marking	Package Information
MD7219A30	3.0	SOT89-3L	MD7219A30PA1	7219A30	Tape and Reel, 1000pcs
MD7219A33	3.3	SOT89-3L	MD7219A33PA1	7219A33	
MD7219A36	3.6	SOT89-3L	MD7219A36PA1	7219A36	
MD7219A40	4.0	SOT89-3L	MD7219A40PA1	7219A40	
MD7219A50	5.0	SOT89-3L	MD7219A50PA1	7219A50	
MD7219AC0	12.0	SOT89-3L	MD7219AC0PA1	7219AC0	
MD7219EC0	12.0	SOT89-3L	MD7219EC0PA1	7219EC0	
MD7219E33	3.3	SOT89-5L	MD7219E33PC1	7219E33	
MD7219E36	3.6	SOT89-5L	MD7219E36PC1	7219E36	Tape and Reel, 2500pcs
MD7219E50	5.0	SOT89-5L	MD7219E50PC1	7219E50	
MD7219C30	3.0	SOT223-3L	MD7219C30YA2	7219C30	
MD7219C33	3.3	SOT223-3L	MD7219C33YA2	7219C33	
MD7219C36	3.6	SOT223-3L	MD7219C36YA2	7219C36	
MD7219C40	4.0	SOT223-3L	MD7219C40YA2	7219C40	
MD7219C50	5.0	SOT223-3L	MD7219C50YA2	7219C50	Tape and Reel, 2500pcs
MD7219CC0	12.0	SOT223-3L	MD7219CC0YA2	7219CC0	
MD7219D30	3.0	TO252-2L	MD7219D30UA2	7219D30	
MD7219D33	3.3	TO252-2L	MD7219D33UA2	7219D33	
MD7219D36	3.6	TO252-2L	MD7219D36UA2	7219D36	

MD7219 Series
High Voltage Low Power Consumption LDO

MD7219D40	4.0	TO252-2L	MD7219D40UA2	 7219D40	
MD7219D50	5.0	TO252-2L	MD7219D50UA2	 7219D50	
MD7219DC0	12.0	TO252-2L	MD7219DC0UA2	 7219DC0	
MD7219E30	3.0	ESOP8	MD7219E30SF4	 7219E30	Tape and Reel, 4000pcs
MD7219E33	3.3	ESOP8	MD7219E33SF4	 7219E33	
MD7219E36	3.6	ESOP8	MD7219E36SF4	 7219E36	
MD7219E40	4.0	ESOP8	MD7219E40SF4	 7219E40	
MD7219E50	5.0	ESOP8	MD7219E50SF4	 7219E50	
MD7219EC0	12.0	ESOP8	MD7219EC0SF4	 7219EC0	
MD7219E18	1.8	SOT23-5L	MD7219E18QC3	 7219E18	Tape and Reel, 3000pcs
MD7219E25	2.5	SOT23-5L	MD7219E25QC3	 7219E25	
MD7219E30	3.0	SOT23-5L	MD7219E30QC3	 7219E30	
MD7219E33	3.3	SOT23-5L	MD7219E33QC3	 7219E33	
MD7219E36	3.6	SOT23-5L	MD7219E36QC3	 7219E36	
MD7219E40	4.0	SOT23-5L	MD7219E40QC3	 7219E40	
MD7219E44	4.4	SOT23-5L	MD7219E44QC3	 7219E44	
MD7219E50	5.0	SOT23-5L	MD7219E50QC3	 7219E50	

Notes:

- 1* Customer can request to customize the output voltage ranged from 1.8V to 12V, if desired voltage is not found in the selections.
- 2* Customer can request customization of package choice.
- 3* Please pay attention to the MARKING of the product package type.

■ Absolute Maximum Ratings (Unless otherwise indicated: T_a=25°C)

PARAMETER	SYMBOL	RATINGS		UNITS
Input Voltage	V _{IN}	-0.3 ~ 20		V
Output Voltage	V _{OUT}	V _{SS} -0.3 ~ V _{IN} +0.3V		
Power Dissipation	P _D	SOT89-3L	1000	mW
		SOT89-5L	1000	
		SOT223-3L	1500	
		TO252-2L	1800	
		ESOP8	800	
		SOT23-5L	250	
Thermal Resistance	R _{θJA}	SOT89-3L	100	°C/W
		SOT89-5L	100	
		SOT223-3L	66	
		TO252-2L	55	
		ESOP8	80	
		SOT23-5L	180	
Operating Ambient Temperature	T _{opr}	-40 ~ +85		°C
Storage Temperature	T _{stg}	-40 ~ +125		
ESD Protection	ESD HBM	4000		V

Note: Stresses above those listed under "Absolute Maximum Ratings" may cause permanent damage to the device.

■ Electrical Characteristics:

MD7219 Series (Unless otherwise indicated: $T_a=25^\circ\text{C}$)

PARAMETER	SYMBOL	CONDITIONS		MIN.	TYP.	MAX.	UNIT
Output Voltage ^{*1}	$V_{OUT(S)}$	$V_{IN} = V_{OUT(S)} + 2V, I_{OUT} = 1mA$		$V_{OUT(S)} \times 0.98$	$V_{OUT(S)}$	$V_{OUT(S)} \times 1.02$	V
Dropout Voltage ^{*2}	V_{DROP}	$V_{OUT(S)} = 3.3V$	$I_{OUT} = 1mA$		3	8	mV
			$I_{OUT} = 1A$		900	1300	
Line Regulation	$\frac{\Delta V_{OUT}}{\Delta V_{IN} \cdot V_{OUT(S)}}$	$V_{OUT(S)} + 2V \leq V_{IN} \leq 18V$ $I_{OUT} = 1mA$			0.01	0.02	%/V
Load Regulation	ΔV_{OUT2}	$V_{IN} = V_{OUT(S)} + 2V$ $1mA \leq I_{OUT} \leq 1A$	$V_{OUT(S)} \leq 5.0V$		80		mV
			$V_{OUT(S)} > 5.0V$		90		
Temperature Stability	$\frac{\Delta V_{OUT}}{\Delta T_a \cdot V_{OUT(S)}}$	$V_{IN} = V_{OUT(S)} + 2V, I_{OUT} = 1mA$ $-40^\circ\text{C} \leq T_a \leq 125^\circ\text{C}$			± 50		ppm/ $^\circ\text{C}$
GND Current	I_{GND}	no load	$V_{OUT(S)} \leq 5.0V$		14	30	μA
			$V_{OUT(S)} > 5.0V$		20	40	
			$I_{OUT} = 100mA$		420		
Shutdown Current	I_{SHUT}	$V_{IN} = 18V, V_{EN} = 0$			0.1	1	
Input Voltage	V_{IN}	---		2.2		18	V
Maximum Output Current	I_{OUTMAX}			1			A
Current Limit ^{*3}	I_{LIM}	$V_{IN} = V_{OUT(S)} + 2V,$ $V_{OUT} = 0.95 \times V_{OUT(S)}$			1.35		
Power Supply Rejection Ratio ^{*4}	PSRR	$f = 10\text{Hz}, I_{OUT} = 10mA$			72		dB
		$f = 100\text{Hz}, I_{OUT} = 10mA$			80		
		$f = 1\text{kHz}, I_{OUT} = 10mA$			75		
Short Circuit Current ^{*5}	I_{SHORT}	$V_{IN} = V_{EN} = V_{OUT(S)} + 2.0V$ $V_{OUT} = 0V$			40		mA
EN 'H' Level Voltage	V_{ENH}			1.6		18	V
EN 'L' Level Voltage	V_{ENL}			0		0.5	
EN 'H' Level Current	I_{ENH}	$V_{IN} = 18V, V_{EN} = V_{IN}$		-0.1		0.1	μA
EN 'L' Level Current	I_{ENL}	$V_{IN} = 18V, V_{EN} = 0$		-0.1		0.1	
Over Temperature Protection	OTP	$I_{OUT} = 1mA$			150		$^\circ\text{C}$

Notes:

- $V_{OUT(S)}$: Output voltage when $V_{IN} = V_{OUT} + 2V, I_{OUT} = 1\text{mA}$.
- $V_{DROP} = V_{IN1} - (V_{OUT(S)} \times 0.98)$ where V_{IN1} is the input voltage when $V_{OUT} = V_{OUT(S)} \times 0.98$.
- I_{LIM} : Output current when $V_{IN} = V_{OUT(S)} + 2V$ and $V_{OUT} = 0.95 \times V_{OUT(S)}$.
- PSRR was measured for $V_{OUT(S)} = 3.3V$ and $V_{IN} = 5.3V$.
- V_{OUT} pin should be shorted to GND pin, and the impedance between them is less than 0.1 ohm.

■ **Typical Performance Characteristics:**

Test Conditions: $V_{IN}=V_{OUT}+2.0V$, $C_{IN}=2.2\mu F$, $C_{OUT}=2.2\mu F$, unless otherwise indicated.

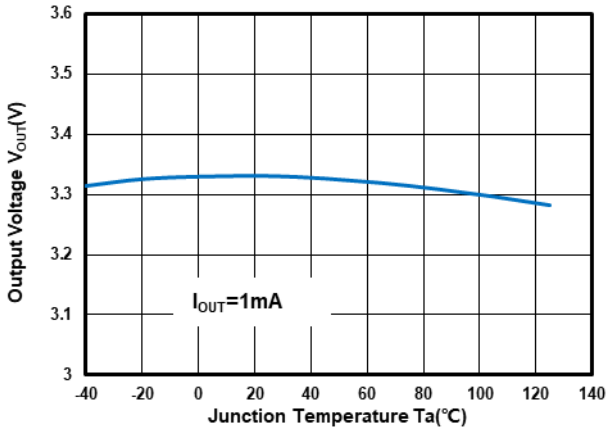

Output Voltage vs Temperature at $V_{OUT}=3.3V$

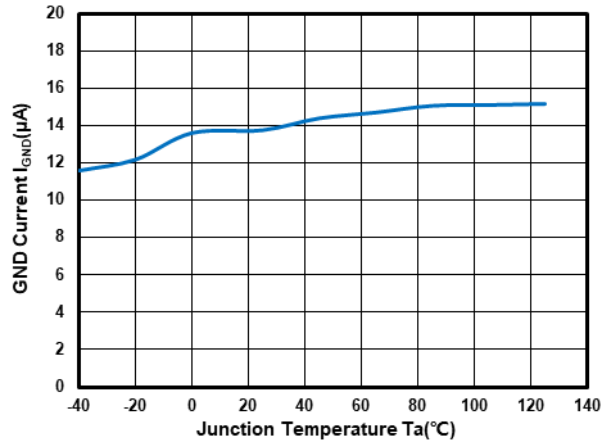

GND Current vs Temperature at $V_{OUT}=3.3V$

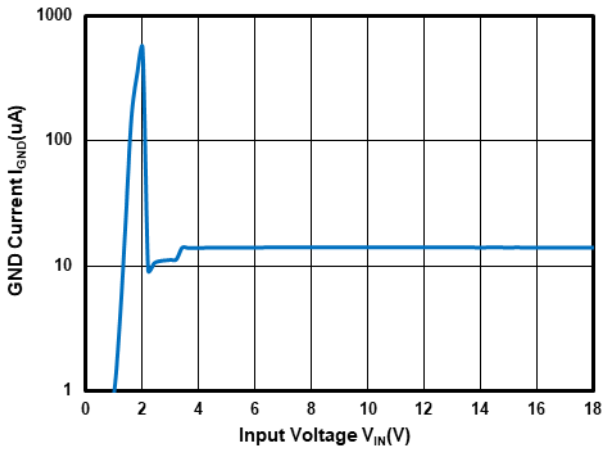

GND Current vs Input Voltage at $V_{OUT}=3.3V$

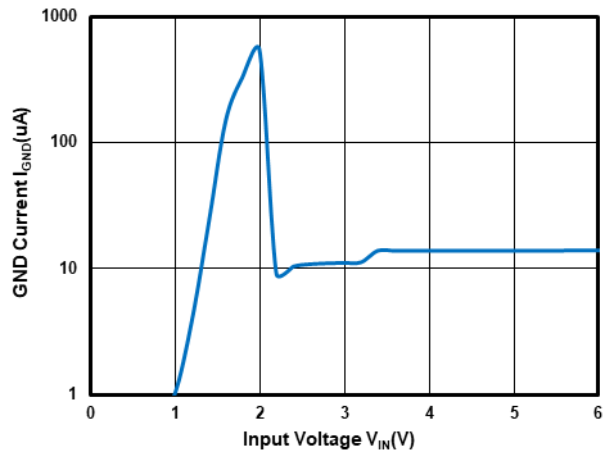

GND Current vs Input Voltage at $V_{OUT}=3.3V$

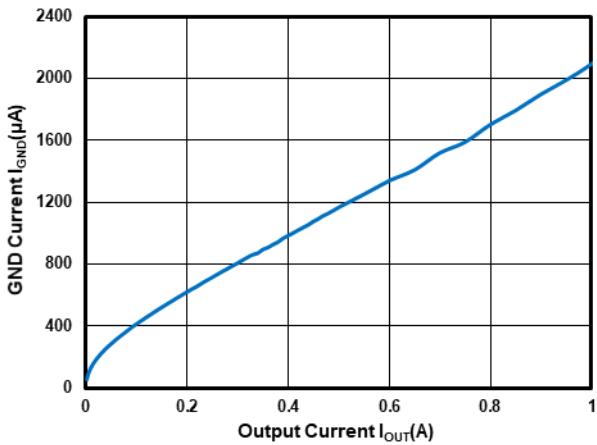

GND Current vs Output Current at $V_{OUT}=3.3V$

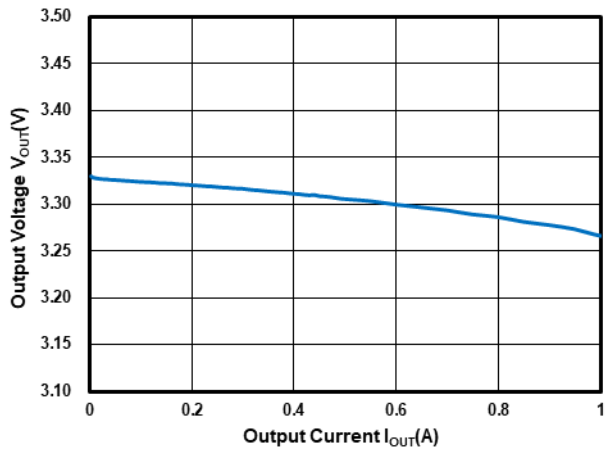

Output Voltage vs Output Current at $V_{OUT}=3.3V$

■ Typical Performance Characteristics (Continued):

Test Conditions: $V_{IN}=V_{OUT}+2.0V$, $C_{IN}=2.2\mu F$, $C_{OUT}=2.2\mu F$, unless otherwise indicated.

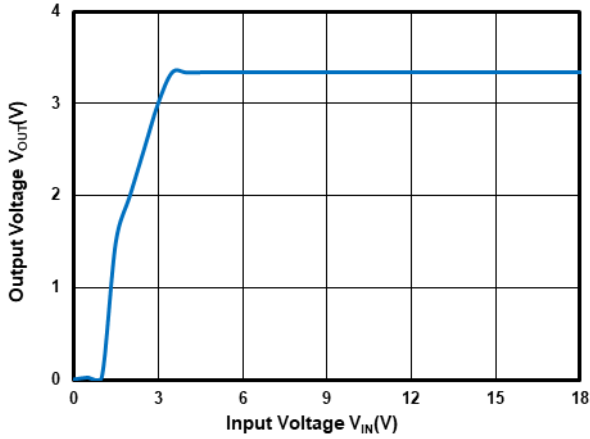

Output Voltage vs Input Voltage at $V_{OUT}=3.3V$

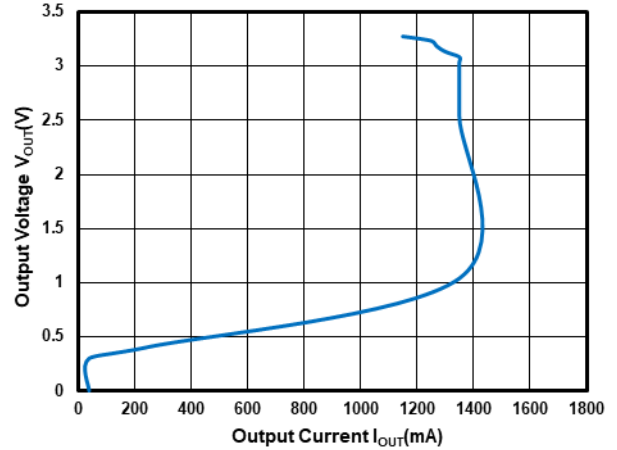

Output Current Fold-back at $V_{OUT}=3.3V$

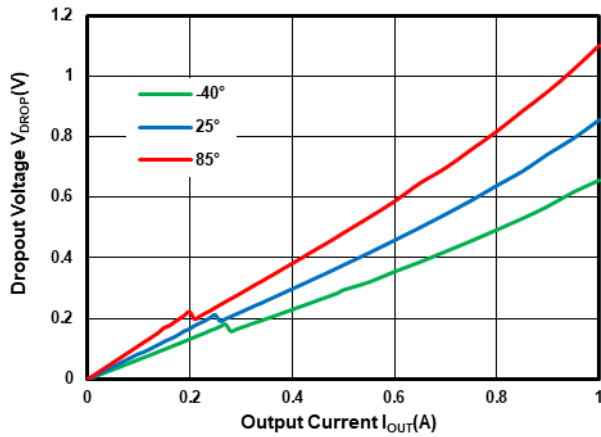

Dropout Voltage vs Temperature at $V_{OUT}=3.3V$

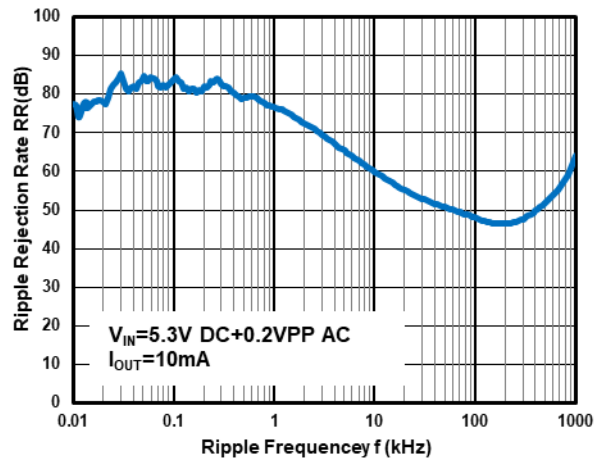

Power Supply Rejection Ratio at $V_{OUT}=3.3V$

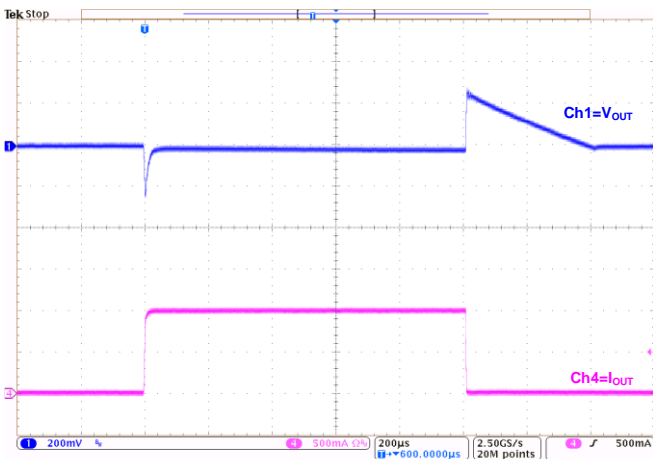

Load Transient at $V_{OUT}=3.3V$
($I_{OUT}=1mA\sim 1A\sim 1mA$)

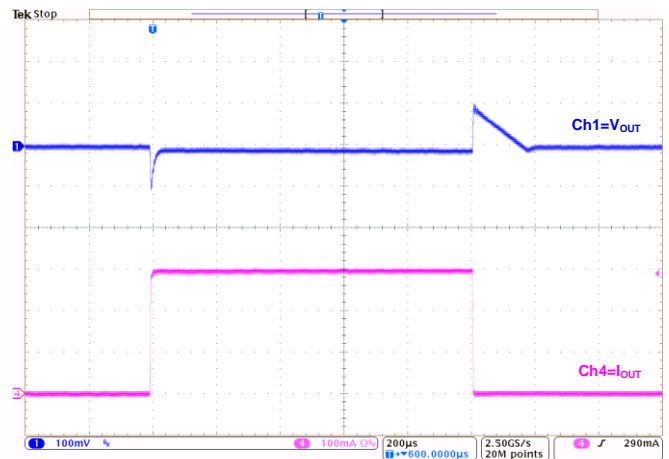

Load Transient at $V_{OUT}=3.3V$
($I_{OUT}=1mA\sim 300mA\sim 1mA$)

■ Typical Performance Characteristics (Continued):

Test Conditions: $V_{IN}=V_{OUT}+2.0V$, $C_{IN}=2.2\mu F$, $C_{OUT}=2.2\mu F$, unless otherwise indicated.

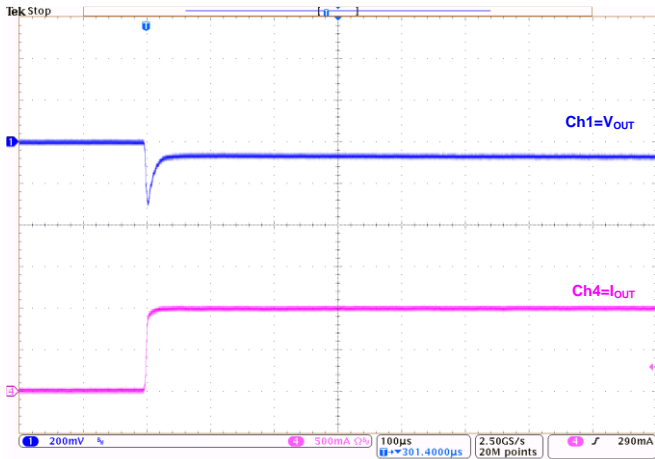

Load Transient at $V_{OUT}=3.3V$
($I_{OUT}=0mA\sim 1A$)

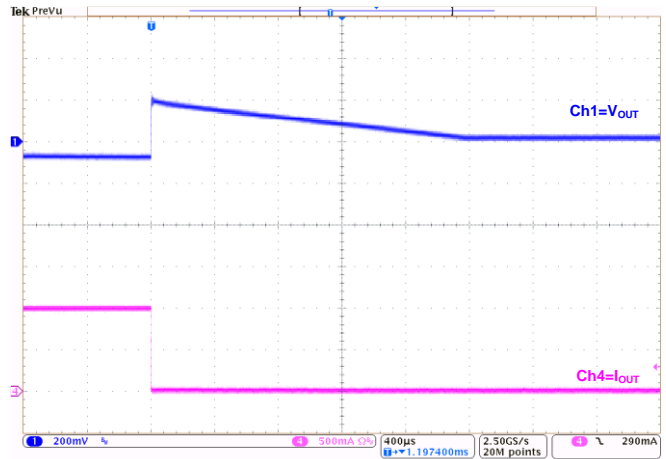

Load Transient at $V_{OUT}=3.3V$
($I_{OUT}=1A\sim 0mA$)

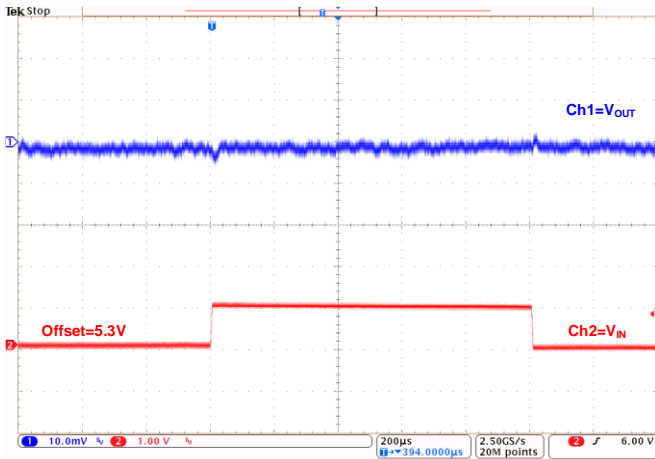

Line Transient at $V_{OUT}=3.3V$
($I_{OUT}=1mA$)

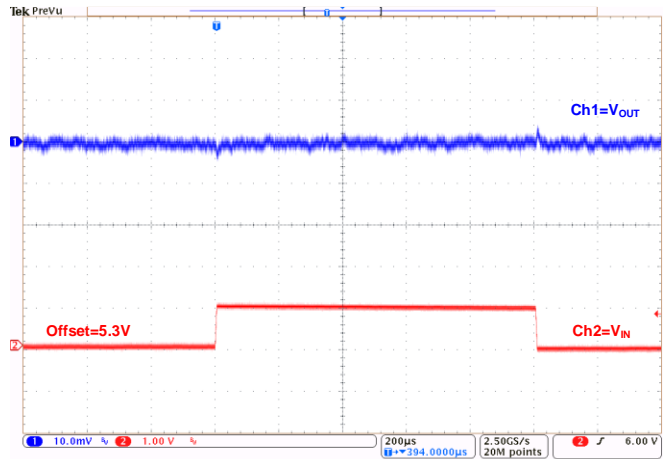

Line Transient at $V_{OUT}=3.3V$
($I_{OUT}=10mA$)

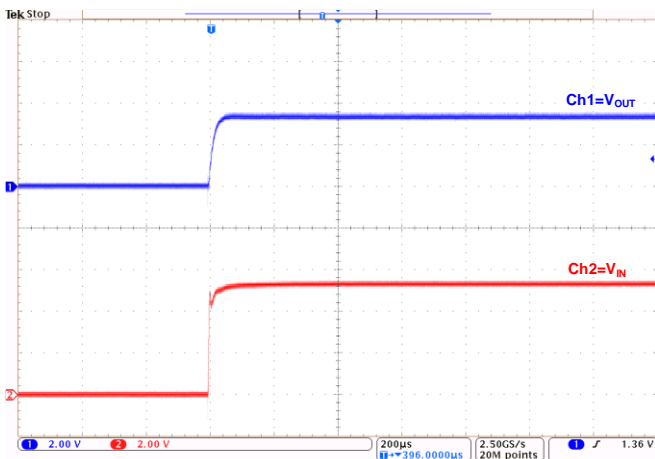

Power-Up at $V_{OUT}=3.3V$:
($I_{OUT}=1mA$)

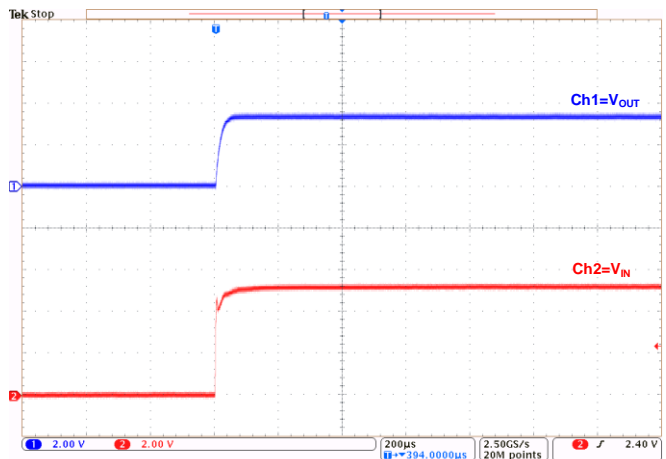

Power-Up at $V_{OUT}=3.3V$:
($I_{OUT}=1A$)

■ Typical Performance Characteristics (Continued):

Test Conditions: $V_{IN}=V_{OUT}+2.0V$, $C_{IN}=2.2\mu F$, $C_{OUT}=2.2\mu F$, unless otherwise indicated.

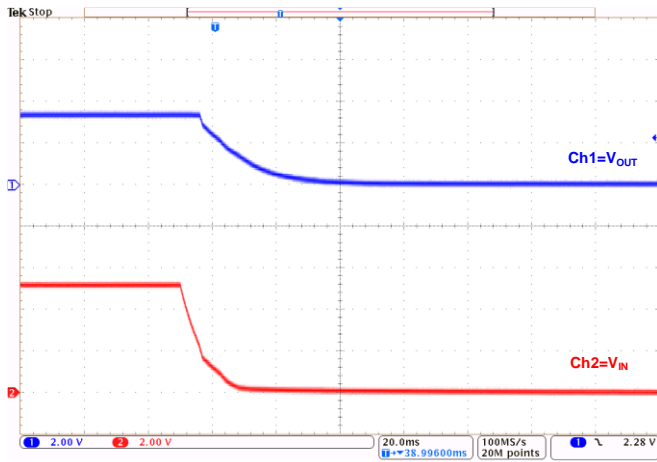

Power-Down at $V_{OUT}=3.3V$:
($I_{OUT}=1mA$)

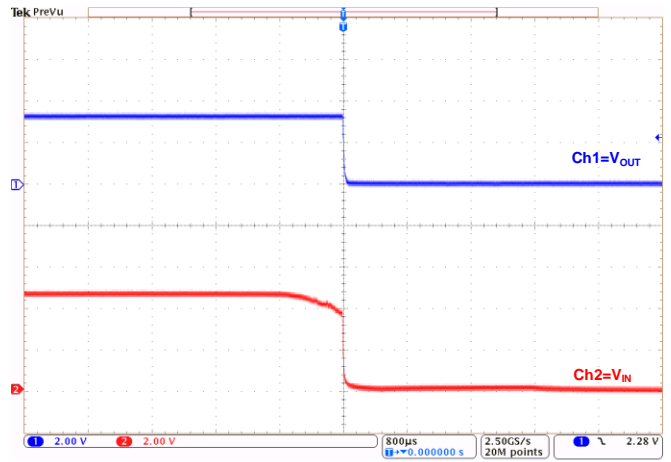

Power-Down at $V_{OUT}=3.3V$:
($I_{OUT}=1A$)

■ **Operational Explanation**

■ **Output voltage control**

The voltage divided by resistors R1 and R2 is compared with the internal reference voltage by the error amplifier. The amplifier output then drives the P-channel MOSFET connected to the V_{OUT} pin. The output voltage at the V_{OUT} pin is regulated by this negative feedback system. The current limit circuit and short protect circuit operate in relation to output current level. Further, the IC's internal circuitry can be in operation or shutdown modes controlled by the CE pin's signal.

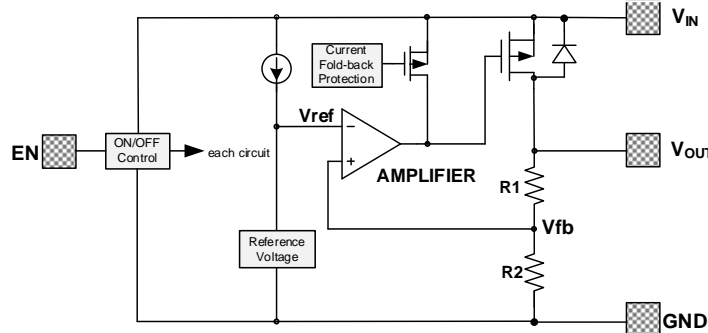

■ **Pass transistor**

The pass transistor with low turn-on resistance used in MD7219 is a P-channel MOSFET. If the potential on V_{OUT} pin is higher than V_{IN} , it is possible that IC will be destroyed due to reverse current which is caused by parasitic diodes between V_{IN} and V_{OUT} . Therefore, the V_{OUT} pin potential exceeds $V_{IN}+0.3V$ is not allowed.

■ **Current limit, over temperature protection**

The MD7219 series includes a combination of a fixed current limiter circuit which aid the operations of the current limiter and circuit protection. When the load current reaches the current limit level, the fixed current limiter circuit operates and output voltage drops. As a result of this drop in output voltage, the foldback circuit operates, output voltage drops further and output current decreases.

Special attention should be paid to that the product of the dropout voltage on the chip and the output current must be smaller than the heat dissipation. If power consumption on the chip is more than the heat dissipation, OTP will protect the chip from damaging due to over temperature.

■ **Notes:**

1. The input and output capacitors should be placed as close as possible to the IC.
2. If the impedance of the power supply is high, which is caused by forgetting installing input capacitor or installing too small value capacitor, the oscillation may occur.
3. Pay attention to the operation conditions of input and output voltage and load current, such that the power consumption in the IC should not exceed the allowable power consumption of the package even though the chip has short circuit protection.
4. IC has a built-in anti-static protection (ESD) circuit, but please do not add excessive stress to the IC.

■ Packaging Information

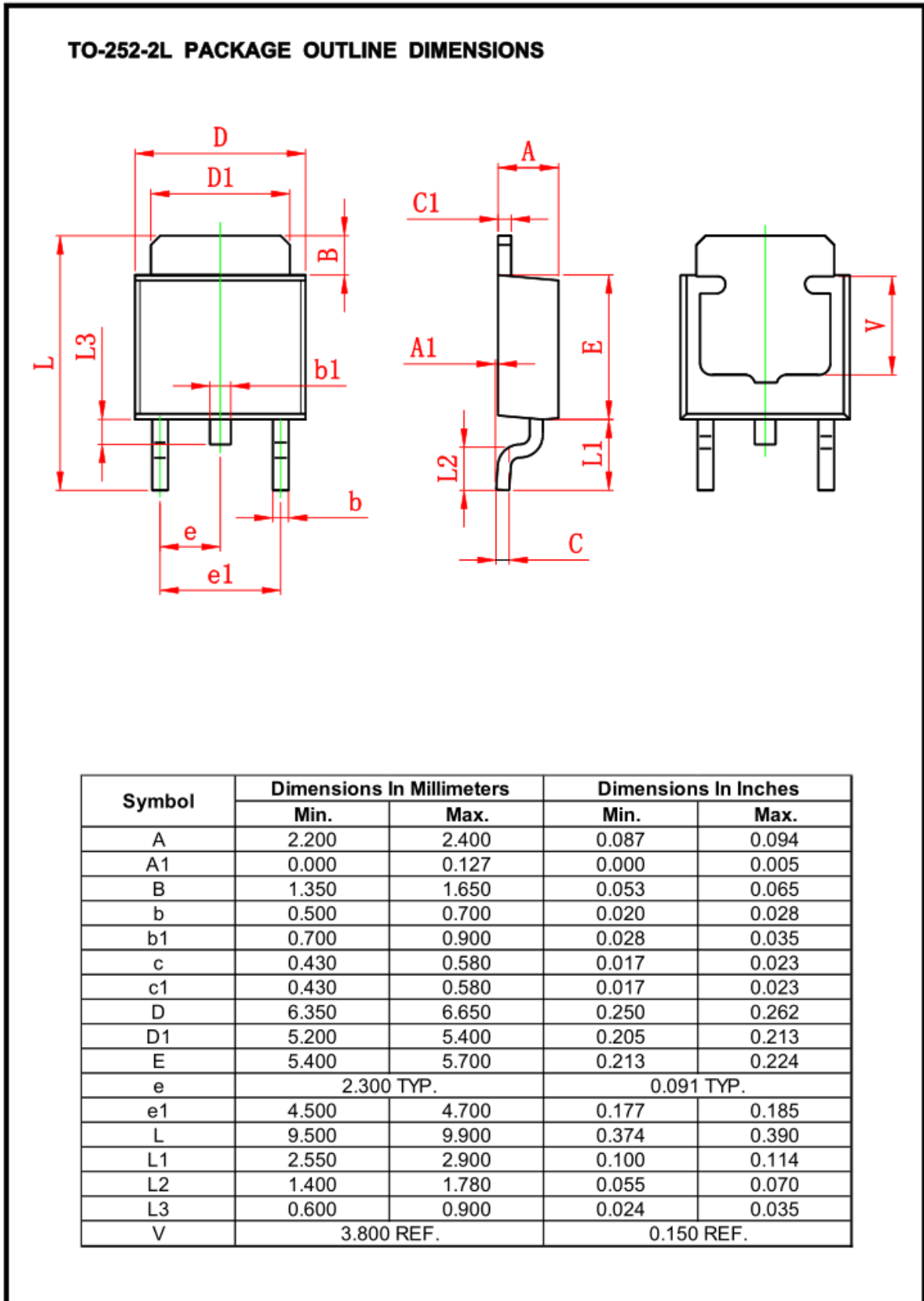

■ Packaging Information (Continued)

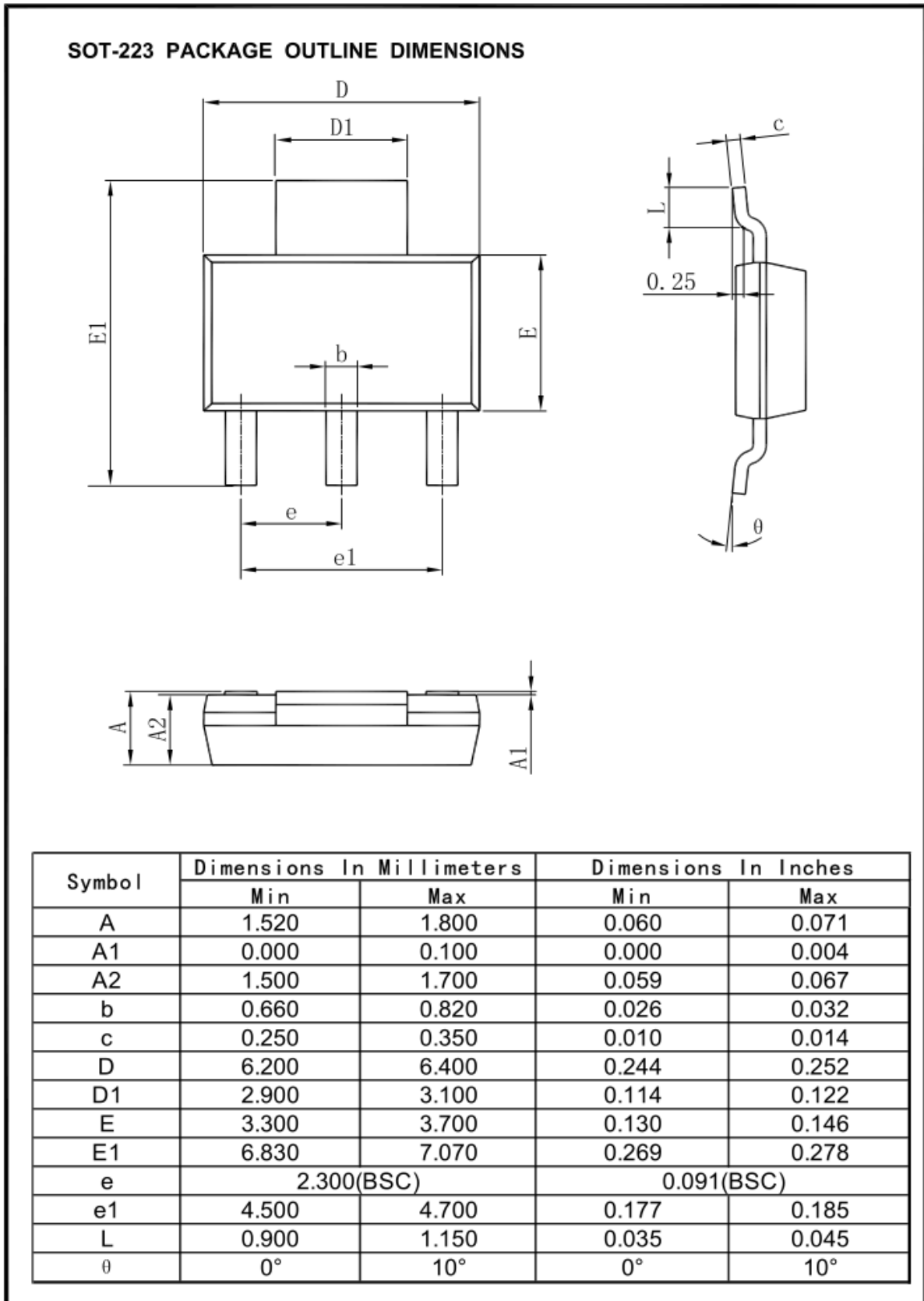

■ Packaging Information (Continued)

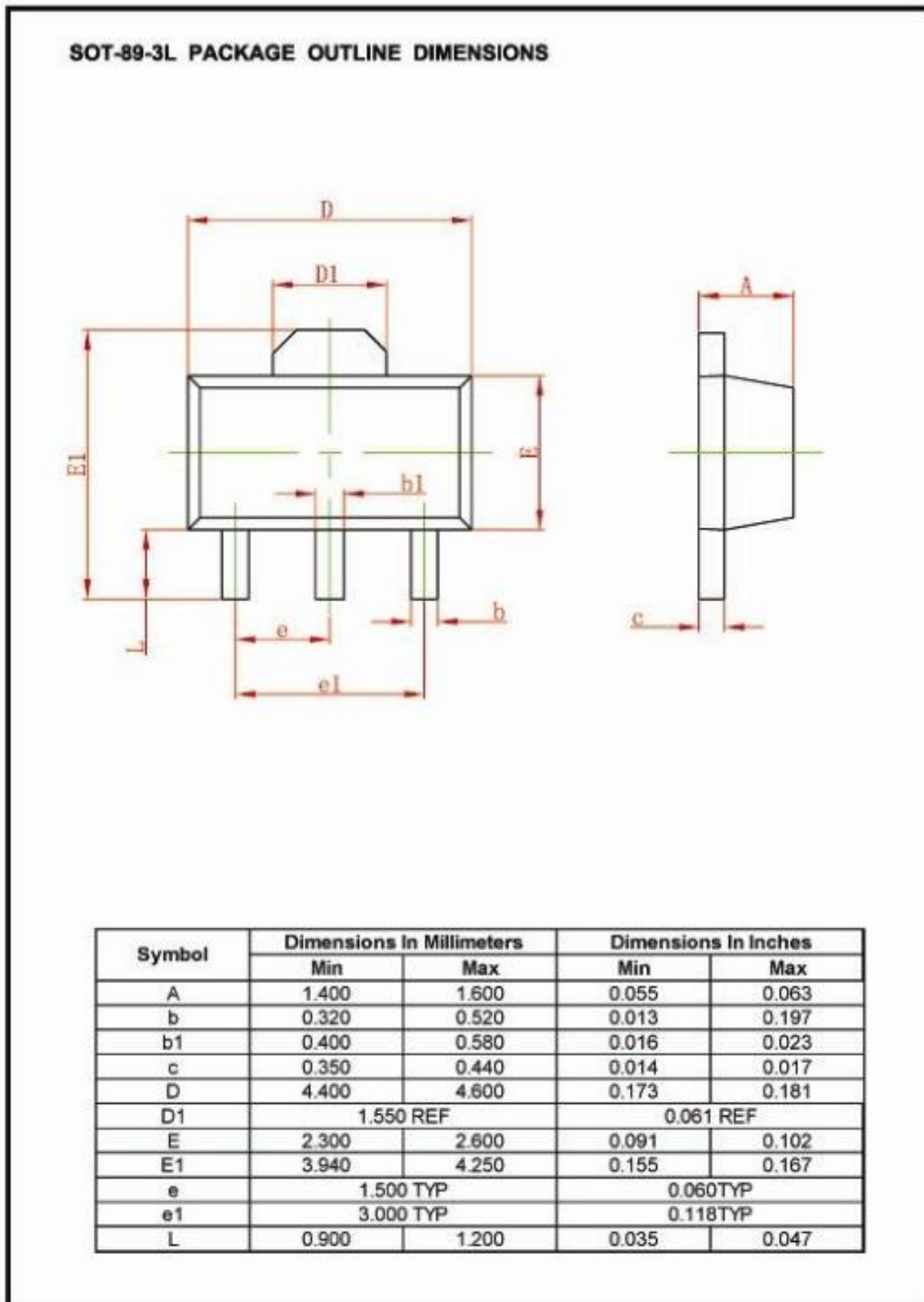

■ Packaging Information (Continued)

ESOP8 PACKAGE OUTLINE DIMENSIONS

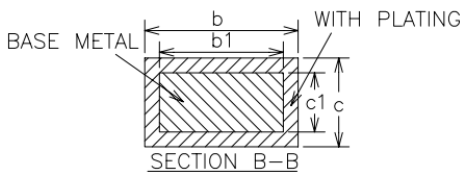
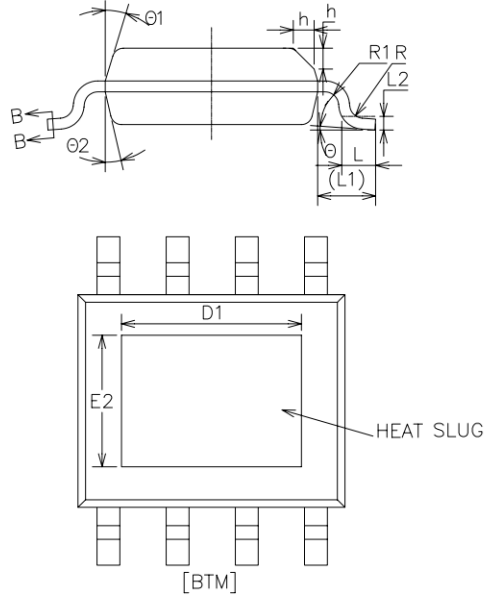
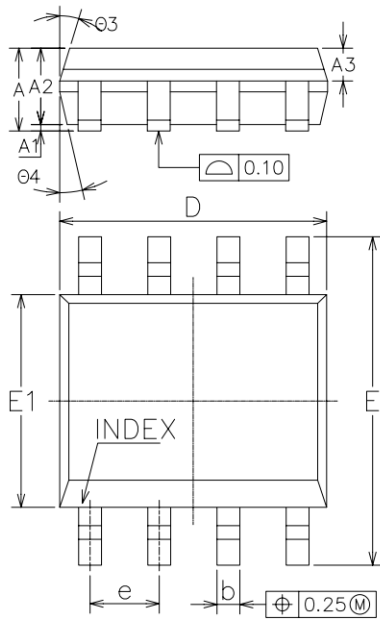

COMMON DIMENSIONS
(UNITS OF MEASURE=MILLIMETER)

SYMBOL	MIN	NOM	MAX
A	1.35	1.55	1.70
A1	0	0.10	0.15
A2	1.25	1.40	1.65
A3	0.50	0.60	0.70
b	0.38	-	0.51
b1	0.37	0.42	0.47
c	0.17	-	0.25
c1	0.17	0.20	0.23
D	4.80	4.90	5.00
D1	Option 1 3.10	3.30	3.50
	Option 2 2.09	2.29	2.49
E	5.80	6.00	6.20
E1	3.80	3.90	4.00
E2	Option 1 2.20	2.40	2.60
	Option 2 2.09	2.29	2.49
e	1.17	1.27	1.37
L	0.45	0.60	0.80
L1	1.04REF		
L2	0.25BSC		
R	0.07	-	-
R1	0.07	-	-
h	0.30	0.40	0.50
θ	0°	-	8°
$\theta 1$	15°	17°	19°
$\theta 2$	11°	13°	15°
$\theta 3$	15°	17°	19°
$\theta 4$	11°	13°	15°

■ Packaging Information (Continued)

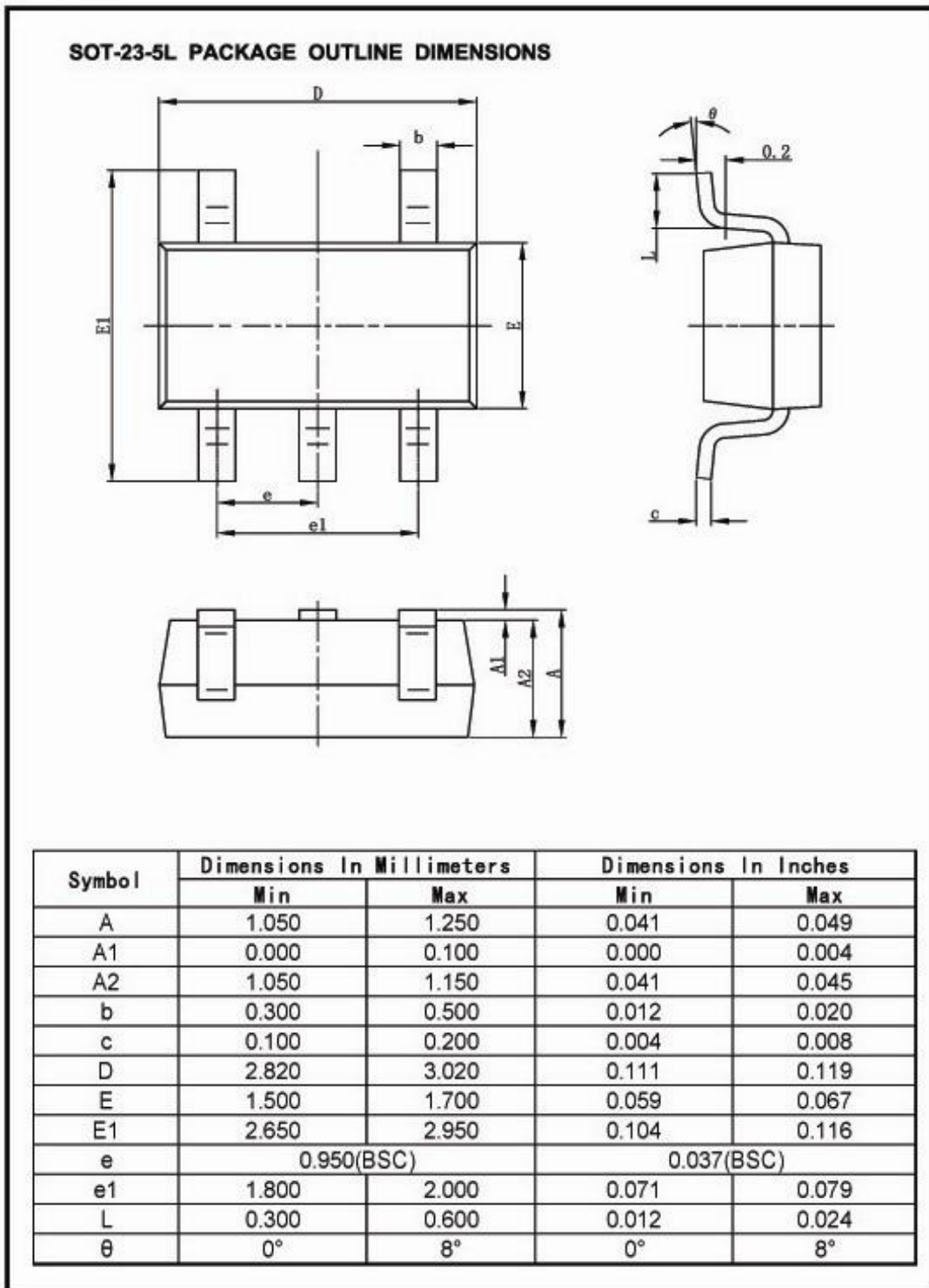

■ Packaging Information (Continued)

SOT-89-5L PACKAGE OUTLINE DIMENSIONS

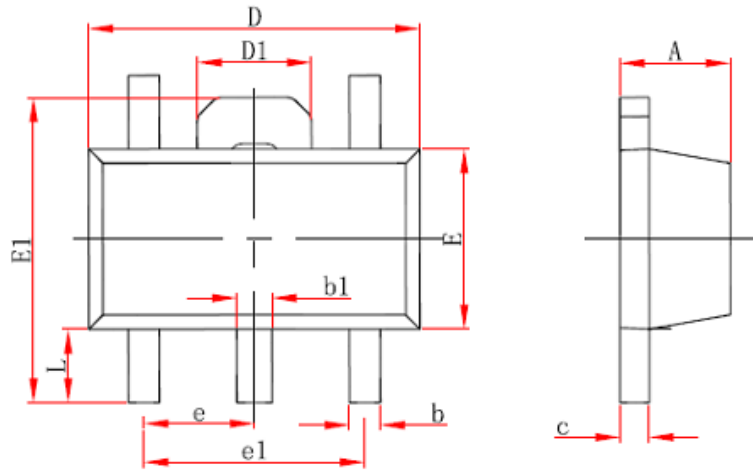

Symbol	Dimensions In Millimeters		Dimensions In Inches	
	Min.	Max.	Min.	Max.
A	1.400	1.600	0.055	0.063
b	0.320	0.520	0.013	0.020
b1	0.380	0.580	0.015	0.023
c	0.350	0.440	0.014	0.017
D	4.400	4.600	0.173	0.181
D1	1.550 REF.		0.061 REF.	
E	2.300	2.600	0.091	0.102
E1	3.940	4.250	0.155	0.167
e	1.500 TYP.		0.060 TYP.	
e1	3.000 TYP.		0.118 TYP.	
L	0.900	1.200	0.035	0.047

For the newest datasheet, please see the website:

www.md-ic.com.cn

Version V1.1:20220302

X-ON Electronics

Largest Supplier of Electrical and Electronic Components

Click to view similar products for [Linear Voltage Regulators](#) category:

Click to view products by [Mingda](#) manufacturer:

Other Similar products are found below :

[LV5684PVD-XH](#) [MCDTSA6-2R](#) [L7815ACV-DG](#) [714954EB](#) [ZMR500QFTA](#) [BA033LBSG2-TR](#) [LV5680P-E](#) [L79M05T-E](#) [L78LR05D-MA-E](#) [NCV317MBTG](#) [NTE7227](#) [MP2018GZD-33-P](#) [MP2018GZD-5-P](#) [LV5680NPVC-XH](#) [LT1054CN8](#) [ZTS6538SE](#) [UA78L09CLP](#) [UA78L09CLPR](#) [CAT6221-PPTD-GT3](#) [MC78M09CDTRK](#) [NCV51190MNTAG](#) [78M05](#) [HT7150-1](#) [UM1540DB-18](#) [XC6234H281VR-G](#) [WL2834CA-6/TR](#) [TPL730F33-5TR](#) [TLS850F1TA](#) [V50](#) [TPS549B22RVFR](#) [UM1540DB-33](#) [WL9200P3-50B](#) [WL9100P3-33B](#) [WL9005D4-33](#) [XC6219B152MR](#) [WL2855K33-3/TR](#) [PJ54BM33SE](#) [PJ9500M25SA](#) [MD7218E33PC1](#) [H7533-2PR](#) [SK7812AU](#) [SD1A30](#) [78L33](#) [TP78L33T3](#) [L78L33ACUTR](#) [SK6513ST3A-50](#) [SK6054D4-09](#) [SK6054D4-18](#) [SK6054D4-11](#) [SK6054D4-10](#) [LM79L12F](#)