

---

---

## High Voltage Low Power Consumption LDO

MD73XXH

## CMOS Voltage Regulator

300mA

---

---



MD73XXH is a high voltage low power low dropout voltage regulator (LDO) manufactured in CMOS processes. It can deliver up to 300mA of current while consuming only 2.4uA of quiescent current, at the same time with high input voltage capacity it can be up to 40V, suitable for applications which requires higher voltage circuit.

### ■ FEATURES:

- Output Voltage Highly Accurate:  $\pm 2\%$
- Dropout Voltage: 3mV@ $I_{OUT}=1mA$
- Low Quiescent Current: 2.4uA
- Temperature Stability:  $\pm 30ppm/^{\circ}C$
- Maximum Input Voltage: 40V
- Current Limit Protection

### ■ APPLICATIONS:

- Automotive electronics
- Intelligent meters and instruments
- Industrial control
- And so on

### ■ TYPICAL APPLICATIONS:

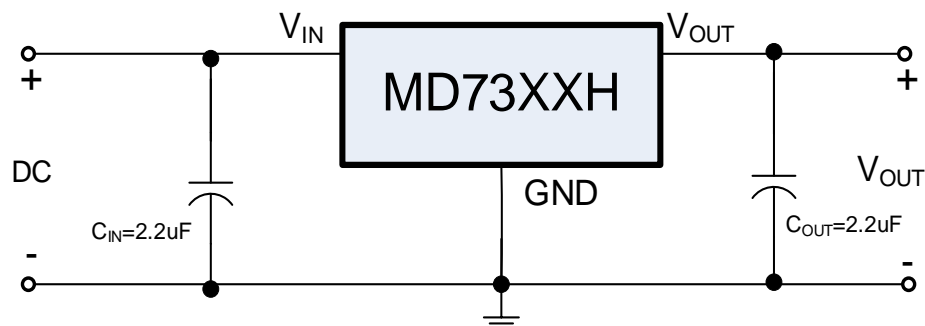

### ■ Notes on Use

- 1.Input Capacitor ( $C_{IN}$ ): 2.2 $\mu F$  above.
- 2.Output Capacitor ( $C_{OUT}$ ): 2.2 $\mu F$  above.

## ■ Pin Configuration and Functions

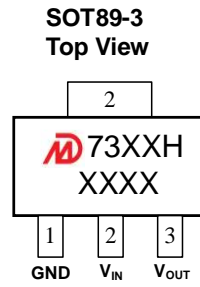
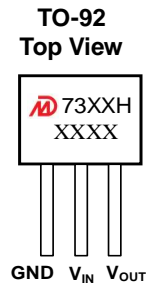

## ■ Product Selections

Product Name	$V_{OUT}$ (V)	Package	Ordering Name	Marking	Package Information
MD7330H	3.0	SOT89-3L	MD73HA30PA1	7330H XXXX	Tape and Reel, 1000pcs
MD7333H	3.3	SOT89-3L	MD73HA33PA1	7333H XXXX	
MD7336H	3.6	SOT89-3L	MD73HA36PA1	7336H XXXX	
MD7340H	4.0	SOT89-3L	MD73HA40PA1	7340H XXXX	
MD7350H	5.0	SOT89-3L	MD73HA50PA1	7350H XXXX	
MD7330H	3.0	TO-92	MD73HA30OA1	7330H XXXX	Bag, 1000pcs
MD7333H	3.3	TO-92	MD73HA33OA1	7333H XXXX	
MD7336H	3.6	TO-92	MD73HA36OA1	7336H XXXX	
MD7340H	4.0	TO-92	MD73HA40OA1	7340H XXXX	
MD7350H	5.0	TO-92	MD73HA50OA1	7350H XXXX	

### Notes:

1\* Customer can request to customize the output voltage ranged from 2.5V to 13V if desired voltage is not found in the selections.

2\* Customer can request customization of package choice.

3\* The characters "XXXX" in the second line of the Marking represents the internal lot number of MD.

## ■ Absolute Maximum Ratings

(Unless otherwise indicated:  $T_a=25^{\circ}\text{C}$ )

PARAMETER	SYMBOL	RATINGS	UNITS
Input Voltage	$V_{IN}$	-0.3 ~ 45	V
Output Voltage	$V_{OUT}$	$V_{SS}-0.3 \sim V_{IN}+0.3V$	
Power Dissipation	$P_D$	SOT89-3 1000	mW
		TO-92 300	
Thermal Resistance	$R_{\theta JA}$	SOT89-3 100	$^{\circ}\text{C}/\text{W}$
		TO-92 250	
Operating Ambient Temperature	$T_{opr}$	-40 ~ +85	$^{\circ}\text{C}$
Storage Temperature	$T_{stg}$	-40 ~ +125	
ESD Protection	ESD HBM	5500	V

**Note:** Stresses above those listed under "Absolute Maximum Ratings" may cause permanent damage to the device.

## ■ ELECTRICAL CHARACTERISTICS

MD73XXH Series

(Unless otherwise indicated: Ta=25°C)

PARAMETER	SYMBOL	CONDITIONS	MIN	TYP	MAX	UNIT
Output Voltage*1	$V_{OUT(S)}$	$V_{IN}=V_{OUT(S)}+2V$ , $I_{OUT}=1mA$	$V_{OUT(S)} \times 0.98$	$V_{OUT(S)}$	$V_{OUT(S)} \times 1.02$	V
Output Current	$I_{OUT}$	$V_{IN} = V_{OUT(S)} + 2V$	300			mA
Dropout Voltage*2	$V_{drop}$	$I_{OUT}=1mA$ $I_{OUT}=300mA$		3 1000	6 1600	mV
Line Regulation	$\frac{\Delta V_{OUT}}{\Delta V_{IN} \cdot V_{OUT(S)}}$	$V_{OUT(S)}+2V \leq V_{IN} \leq 40V$ $I_{OUT} = 1mA$		0.01	0.15	%/V
Load Regulation	$\Delta V_{OUT2}$	$V_{IN} = V_{OUT(S)}+2V$ $1mA \leq I_{OUT} \leq 300mA$		40	90	mV
Temperature Stability		$V_{IN} = V_{OUT(S)}+2V$ , $I_{OUT}=10mA$ $-40^{\circ}C \leq T_a \leq 85^{\circ}C$		±30		ppm/°C
Quiescent Current	$I_{SS}$	$V_{IN} = 40V$ , no load		2.4	4	uA
Input Voltage	$V_{INmax}$	---			40	V
Current Limit*3	$I_{LIM}$	$V_{IN} = V_{OUT(S)}+3V$ , $V_{OUT} = 0.9 \cdot V_{OUT(S)}$		630		mA
Power Supply Rejection Ratio	PSRR	f=100Hz, IOUT=10mA		73		dB
		f=1kHz, IOUT=10mA		83		
		f=10kHz, IOUT=10mA		80		
		f=100kHz, IOUT=10mA		60		

### Notes:

1.  $V_{OUT(S)}$ : Output voltage when  $V_{IN}=V_{OUT}+2V$ ,  $I_{OUT}=1 mA$ .
2.  $V_{DROP}=V_{IN1} - (V_{OUT(S)} \times 0.98)$  where  $V_{IN1}$  is the input voltage when  $V_{OUT} = V_{OUT(S)} \times 0.98$ .
3.  $I_{LIM}$ : Output current when  $V_{IN}=V_{OUT(S)}+3V$  and  $V_{OUT} = 0.9 \cdot V_{OUT(S)}$ .

■ **Typical Performance Characteristics:**

Test Conditions:  $V_{IN}=V_{OUT}+2.0V$ ,  $C_{IN}=2.2\mu F$ ,  $C_{OUT}=2.2\mu F$ ,  $T_a=25^\circ C$ , unless otherwise indicated.

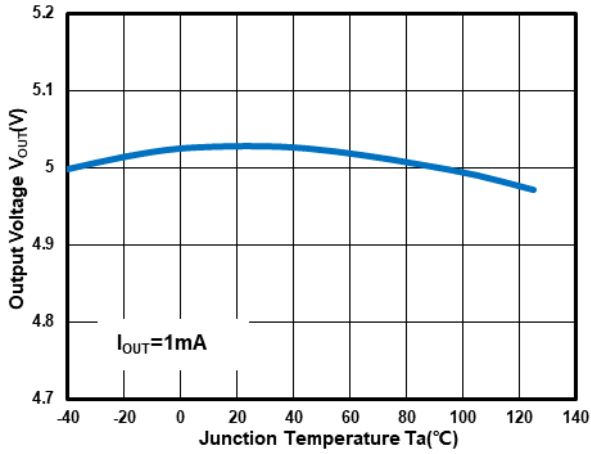

Output Voltage vs. Temperature at  $V_{OUT}=5V$

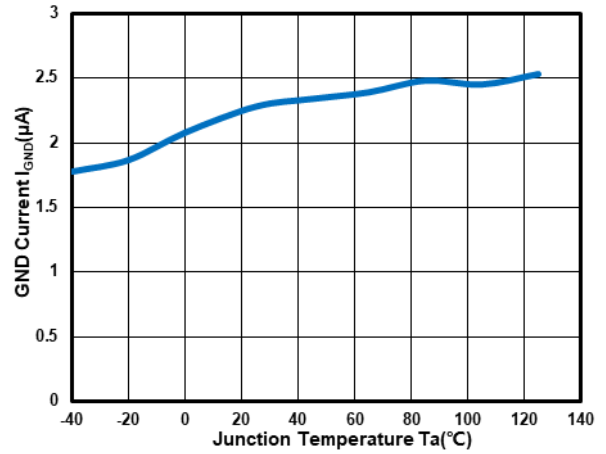

GND Current vs. Temperature at  $V_{OUT}=5V$

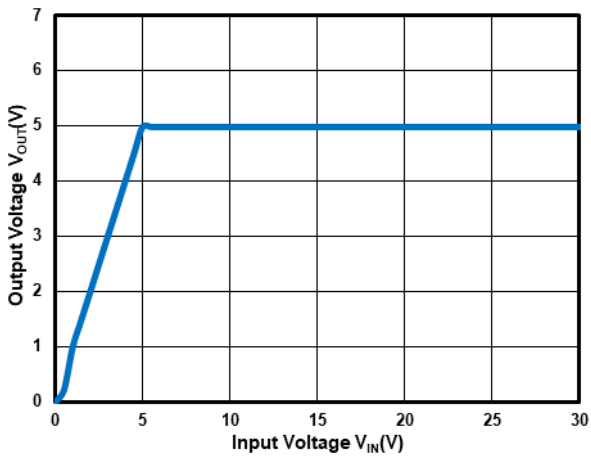

Output Voltage vs. Input Voltage at  $V_{OUT}=5V$

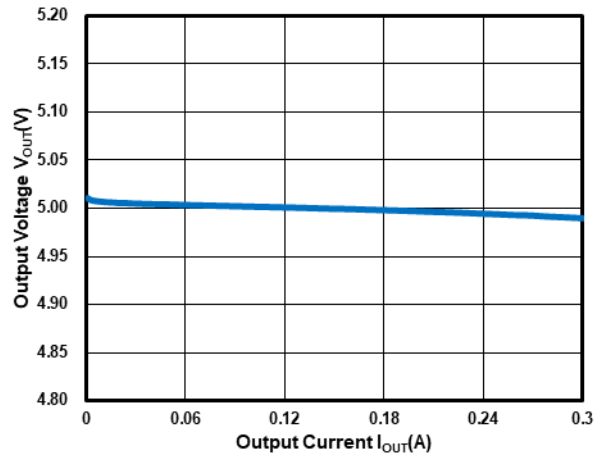

Output Current vs. Output Voltage at  $V_{OUT}=5V$

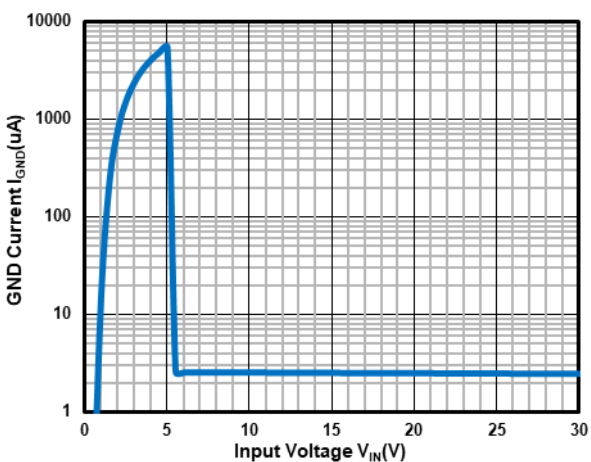

GND Current vs. Input Voltage at  $V_{OUT}=5V$

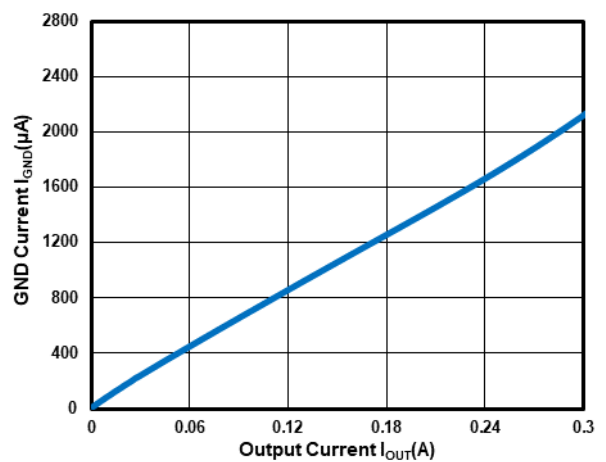

Output Current vs. GND Current at  $V_{OUT}=5V$

■ **Typical Performance Characteristics:**

Test Conditions:  $V_{IN}=V_{OUT}+2.0V$ ,  $C_{IN}=2.2\mu F$ ,  $C_{OUT}=2.2\mu F$ ,  $T_a=25^\circ C$ , unless otherwise indicated.

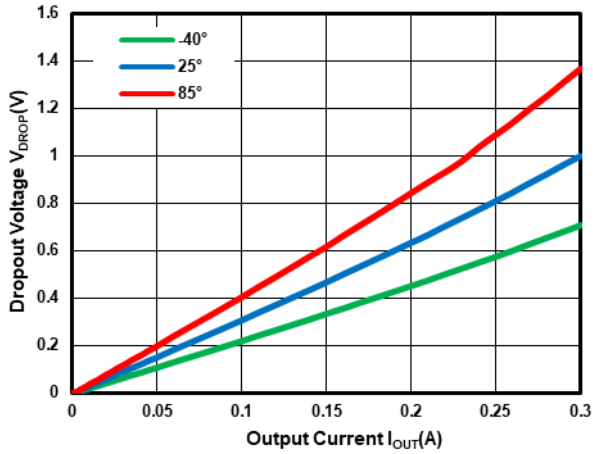

Output Voltage vs. Input Voltage at  $V_{OUT}=5V$

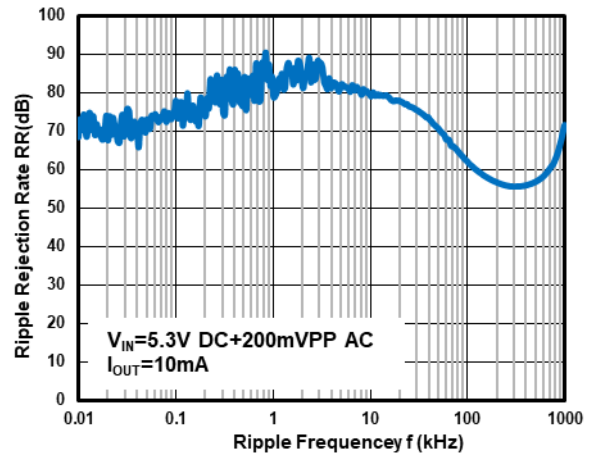

Power Supply Rejection Ratio at  $V_{OUT}=5V$

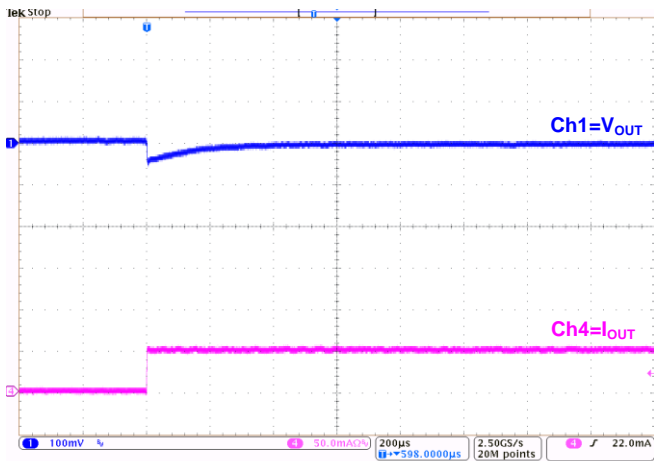

Load Transient at  $V_{OUT}=5V$ :  
( $I_{OUT}=0mA\sim 50mA$ )

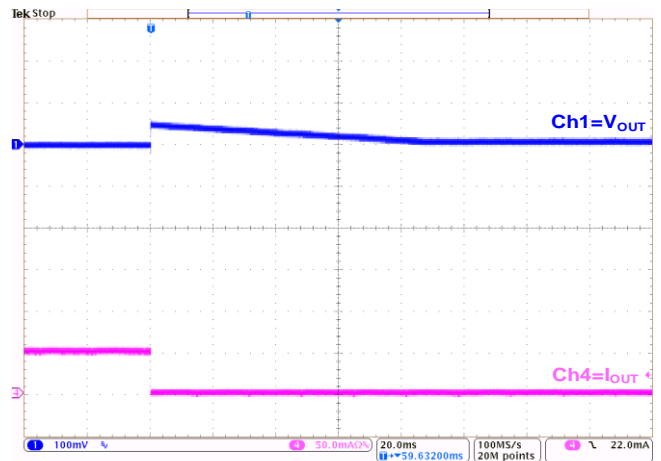

Load Transient at  $V_{OUT}=5V$ :  
( $I_{OUT}=50mA\sim 0mA$ )

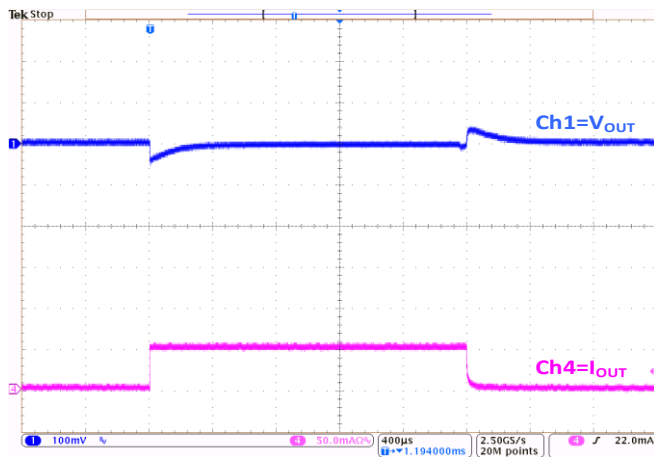

Load Transient at  $V_{OUT}=5V$ :  
( $I_{OUT}=1mA\sim 50mA\sim 1mA$ )

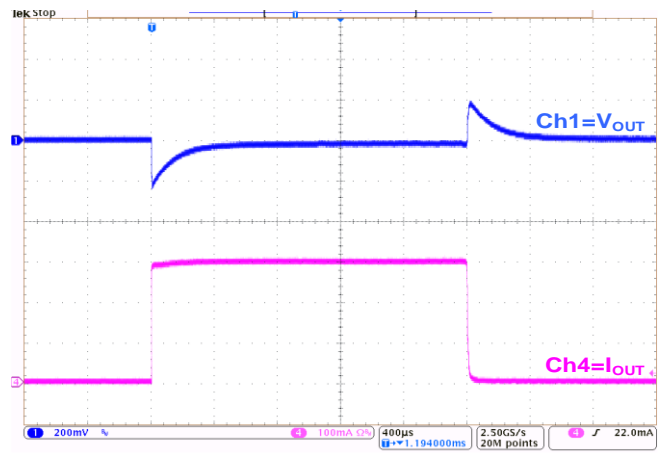

Load Transient at  $V_{OUT}=5V$ :  
( $I_{OUT}=1mA\sim 300mA\sim 1mA$ )

■ **Typical Performance Characteristics:**

Test Conditions:  $V_{IN}=V_{OUT}+2.0V$ ,  $C_{IN}=2.2\mu F$ ,  $C_{OUT}=2.2\mu F$ ,  $T_a=25^\circ C$ , unless otherwise indicated.

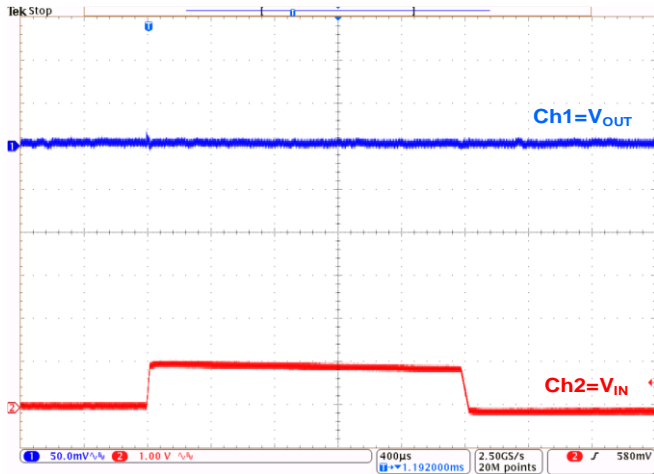

Line Transient at  $V_{OUT}=5V$ :  
( $I_{OUT}=1mA$ )

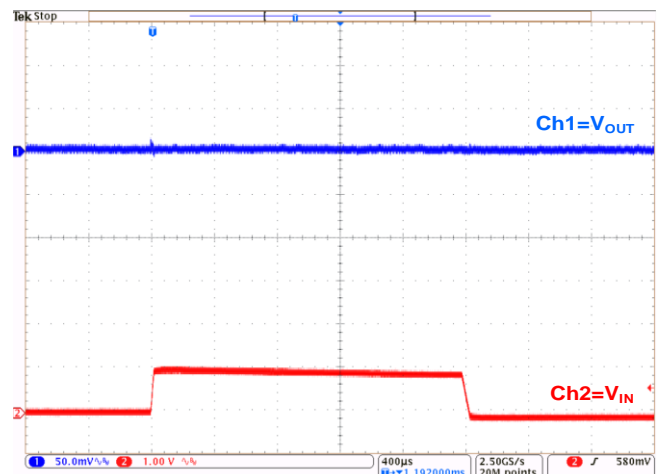

Line Transient at  $V_{OUT}=5V$ :  
( $I_{OUT}=10mA$ )

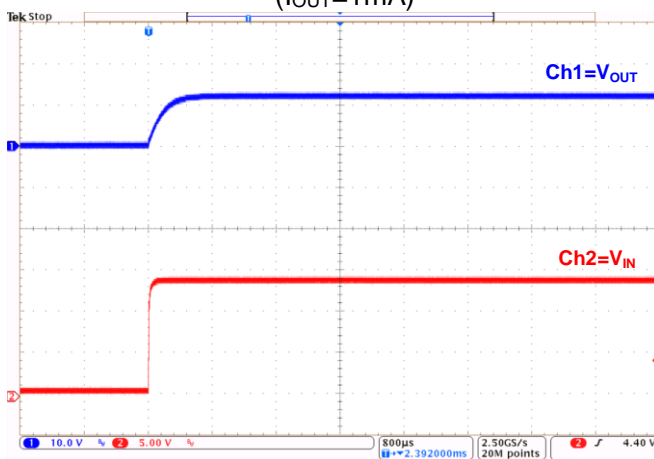

Power-Up at  $V_{OUT}=5V$ :  
( $I_{OUT}=1mA$ )

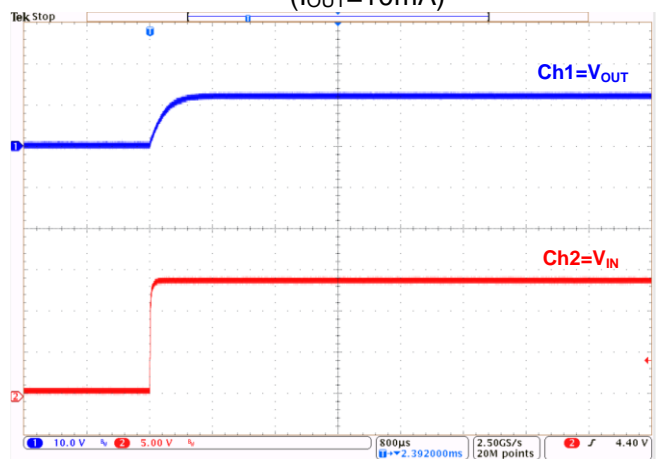

Power-Up at  $V_{OUT}=5V$ :  
( $I_{OUT}=300mA$ )

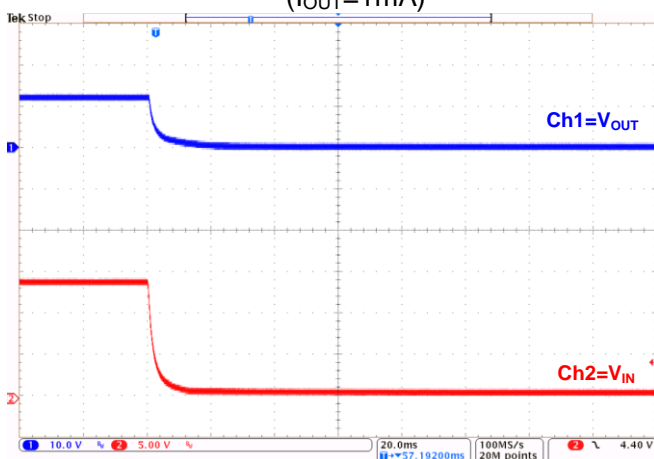

Power-Down at  $V_{OUT}=5V$ :  
( $I_{OUT}=1mA$ )

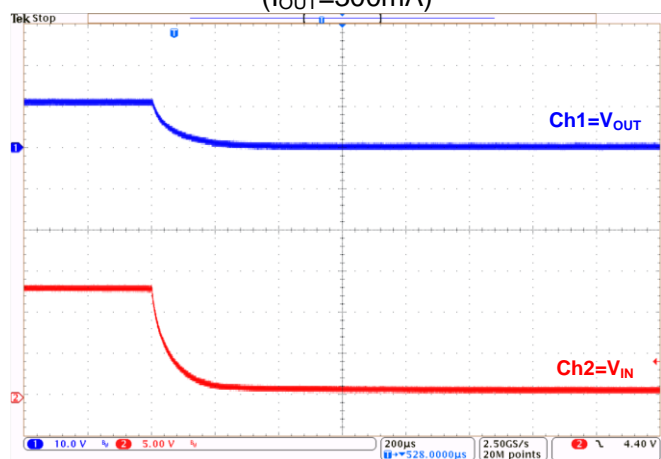

Power-Down at  $V_{OUT}=5V$ :  
( $I_{OUT}=300mA$ )

## ■ OPERATIONAL EXPLANATION:

### 1. Output voltage control

The voltage divided by resistors  $R_f$  and  $R_s$  is compared with the internal reference voltage by the error amplifier. The amplifier output then drives the P-channel MOSFET connected to the VOUT pin. The output voltage at the VOUT pin is regulated by this negative feedback system. The current limit circuit operates in relation to output current level.

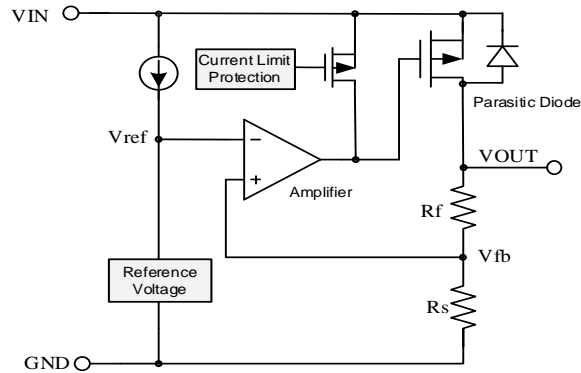

### 2. Pass transistor

The pass transistor with low turn-on resistance used in MD73HXX is a P-channel MOSFET. If the potential on VOUT pin is higher than VIN, it is possible that IC will be destroyed due to reverse current which is caused by parasitic diodes between VIN and VOUT. Therefore, the VOUT pin potential exceeds  $V_{IN} + 0.3V$  is not allowed.

### 3. Circuit limit protection

The MD73HXX includes current limit protection feature. If the output is overloaded or shorted to ground, it can inhibit the current of 630mA (typical value), therefore, the chip can avoid damage. Special attention should be paid to that the product of the dropout voltage on the chip and the output current must be smaller than the heat dissipation.

## ■ Notes:

1. The input and output capacitors should be placed as close as possible to the IC.
2. If the impedance of the power supply is high, which is caused by forgetting installing input capacitor or installing too small value capacitor, the oscillation may occur.

## ■ Packaging Information

### SOT-89-3L PACKAGE OUTLINE DIMENSIONS

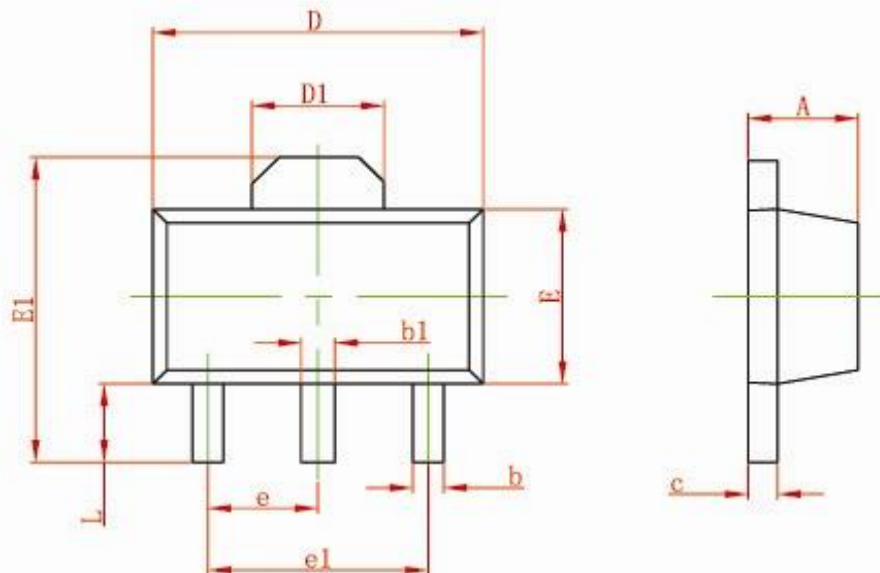

Symbol	Dimensions In Millimeters		Dimensions In Inches	
	Min	Max	Min	Max
A	1.400	1.600	0.055	0.063
b	0.320	0.520	0.013	0.197
b1	0.400	0.580	0.016	0.023
c	0.350	0.440	0.014	0.017
D	4.400	4.600	0.173	0.181
D1	1.550 REF		0.061 REF	
E	2.300	2.600	0.091	0.102
E1	3.940	4.250	0.155	0.167
e	1.500 TYP		0.060TYP	
e1	3.000 TYP		0.118TYP	
L	0.900	1.200	0.035	0.047



## ■ Packaging Information (Continued)

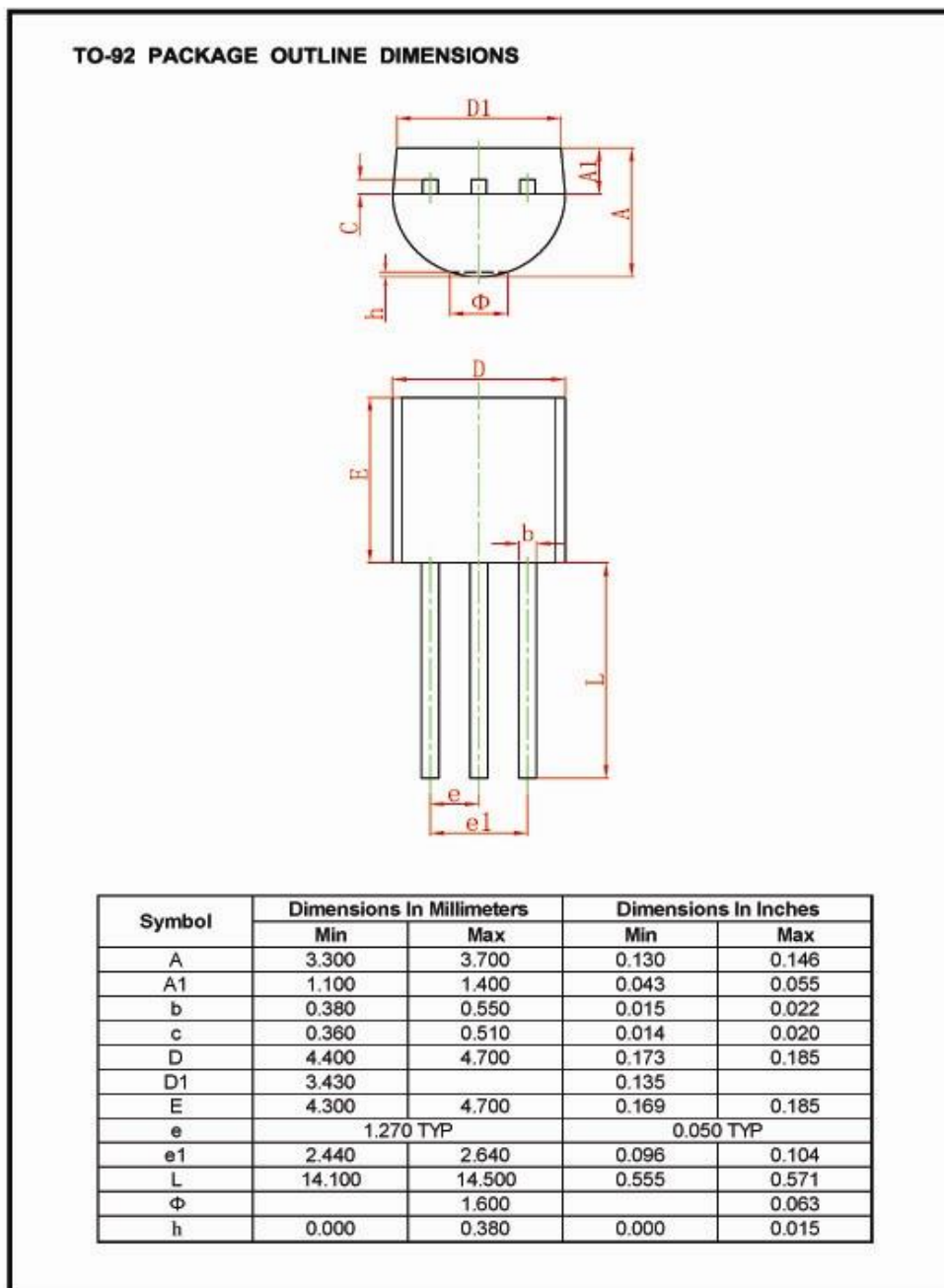

For the newest datasheet, please see the website:

[www.md-ic.com.cn](http://www.md-ic.com.cn)

Version V1.0 20230821

## X-ON Electronics

Largest Supplier of Electrical and Electronic Components

*Click to view similar products for [Linear Voltage Regulators](#) category:*

*Click to view products by [Mingda](#) manufacturer:*

Other Similar products are found below :

[LV5684PVD-XH](#) [MCDTSA6-2R](#) [L7815ACV-DG](#) [714954EB](#) [ZMR500QFTA](#) [BA033LBSG2-TR](#) [LV5680P-E](#) [L79M05T-E](#) [L78LR05D-MA-E](#) [NCV317MBTG](#) [NTE7227](#) [MP2018GZD-33-P](#) [MP2018GZD-5-P](#) [LV5680NPVC-XH](#) [LT1054CN8](#) [UA78L09CLP](#) [UA78L09CLPR](#) [CAT6221-PPTD-GT3](#) [MC78M09CDTRK](#) [NCV51190MNTAG](#) [78M05](#) [HT7150-1](#) [UM1540DB-18](#) [XC6234H281VR-G](#) [WL2834CA-6/TR](#) [TPL730F33-5TR](#) [TLS850F1TA](#) [V50](#) [TPS549B22RVFR](#) [UM1540DB-33](#) [WL9200P3-50B](#) [WL9100P3-33B](#) [WL9005D4-33](#) [XC6219B152MR](#) [WL2855K33-3/TR](#) [PJ54BM33SE](#) [PJ9500M25SA](#) [MD7218E33PC1](#) [H7533-2PR](#) [SK7812AU](#) [SD1A30](#) [78L33](#) [TP78L33T3](#) [L78L33ACUTR](#) [SK6513ST3A-50](#) [SK6054D4-09](#) [SK6054D4-18](#) [SK6054D4-11](#) [SK6054D4-10](#) [LM79L12F](#) [HLP2985AIM5X-5.0](#)