



MD84XX is a high voltage (up to 40V) low power low dropout voltage regulator (LDO) manufactured in CMOS processes. It can deliver up to 300mA of current while consuming only 1.5uA of quiescent current. It consists of a reference voltage generator, an error amplifier, a current foldback circuit, and a phase compensation circuit plus a driver transistor.

■ Features

- Ultra-low Quiescent Current: 1.5uA
- Maximum Input Voltage: 40V
- Output Voltage Highly Accurate: $\pm 2\%$
- Maximum Output Current: 300mA
- Dropout Voltage: 4mV@ $I_{OUT}=1mA$
- Temperature Stability: $\pm 50ppm/^{\circ}C$
- ON/OFF Logic = Enable High
- Protections Circuits: Current Limiter, Foldback, Thermal shutdown
- Output Capacitor: Low ESR Ceramic Capacitor Compatible

■ Applications

- Smart wearer
- Long-life battery-powered devices
- Portable mobile devices, such as mobile phones, cameras, and so on
- Wireless communication equipment

■ Product Selections

| Type | Output Voltage (note 1*) | Current Limit | Accuracy | Package (note 2*) | MARKING (note 3*) |
|--------|--------------------------|---------------|-----------|---|-----------------------------|
| MD8425 | 2.5V | 550mA | $\pm 2\%$ | SOT23-5\SOT23-3 | 8425 8425M |
| MD8427 | 2.7V | 550mA | $\pm 2\%$ | SOT23-5 | 8427M |
| MD8428 | 2.8V | 550mA | $\pm 2\%$ | SOT23-5\SOT23-3 | 8428 |
| MD8430 | 3.0V | 550mA | $\pm 2\%$ | SOT23-5\SOT23-3 | 8430 8430M |
| MD8433 | 3.3V | 550mA | $\pm 2\%$ | SOT23-5\SOT23-3 TO252-4 | 8433 8433S 8433M 8433Q |
| MD8436 | 3.6V | 550mA | $\pm 2\%$ | SOT23-5\SOT23-3 | 8436 8436M |
| MD8440 | 4.0V | 550mA | $\pm 2\%$ | SOT23-5\SOT23-3 | 8440 8440M |
| MD8445 | 4.5V | 550mA | $\pm 2\%$ | SOT23-5 | 8445Q |
| MD8450 | 5.0V | 550mA | $\pm 2\%$ | SOT23-5\SOT23-3 DFN(2*2)-6\ESOP8 DFN(1.6*1.6)-6 | 8450 8450M |
| MD8465 | 6.5V | 550mA | $\pm 2\%$ | SOT23-3 | 8465 |
| MD8410 | 10V | 550mA | $\pm 2\%$ | SOT23-5 | 8410 |
| MD8412 | 12V | 550mA | $\pm 2\%$ | SOT23-5\ESOP8 | 8412 |

Notes:

1* Customer can request to customize the output voltage ranged from 1.2V to 15V if desired voltage is not found in the selections.

2* Customer can request customization of package choice.

3* Please pay attention to the MARKING of the product package type.

Pin Configuration and Functions

**SOT23-5
Top View**

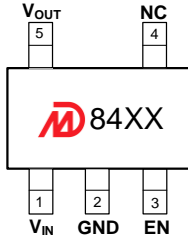

**SOT23-5(S_Type)
Top View**

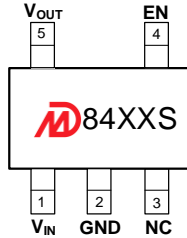

**SOT23-5(M_Type)
Top View**

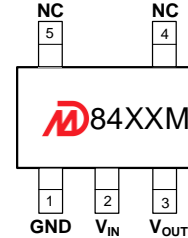

**SOT23-5(Q_Type)
Top View**



**SOT23-3
Top View**

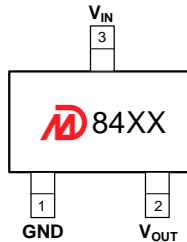

**TO252-4
Top View**



**ESOP8
Top View**

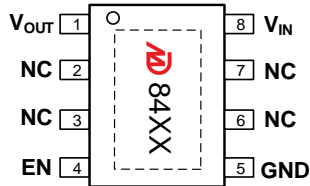

**DFN(1.6*1.6)-6
Top View**

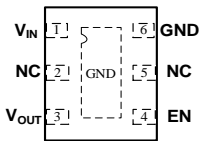

**DFN(2*2)-6
Top View**

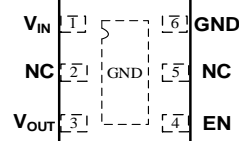

Pin Functions

| NAME | DESCRIPTION |
|------------------|--|
| V _{IN} | Power Input Pin. |
| EN | Enable pin. Drive this pin high to enable the device. Drive this pin low to put the device into low current shutdown. |
| V _{OUT} | Regulated output voltage pin |
| GND | Ground |
| Thermal pad | The thermal pad is electrically connected to the GND node. Connect this pad to the GND plane for improved thermal performance. |
| NC | No internal connection |

■ Absolute Maximum Ratings (Unless otherwise indicated: $T_a=25^\circ\text{C}$)

| PARAMETER | SYMBOL | RATINGS | | UNITS |
|-------------------------------|-----------------------|-------------------------------|------|--------------------|
| Input Voltage | V_{IN} | -0.3 ~ 45 | | V |
| Output Voltage | V_{OUT} | $V_{SS}-0.3 \sim V_{IN}+0.3V$ | | |
| Power Dissipation | P_D | SOT23-5 | 250 | mW |
| | | SOT23-3 | 250 | |
| | | ESOP8 | 1800 | |
| | | TO-252 | 1800 | |
| Thermal Resistance | $R_{\theta JB}^{(1)}$ | SOT23-5 | 180 | $^\circ\text{C/W}$ |
| | | SOT23-3 | 200 | |
| | | ESOP8 | 80 | |
| | | TO-252 | 60 | |
| Operating Ambient Temperature | T_{opr} | -40 ~ +85 | | $^\circ\text{C}$ |
| Storage Temperature | T_{stg} | -40 ~ +125 | | |
| ESD Protection | ESD HBM | 2000 | | V |
| Moisture Sensitivity Level | MSL | 3 | | |

Note: Stresses above those listed under "Absolute Maximum Ratings" may cause permanent damage to the device.

⁽¹⁾ Mounted on JEDEC standard 4layer (2s2p) PCB test board

■ Typical Applications

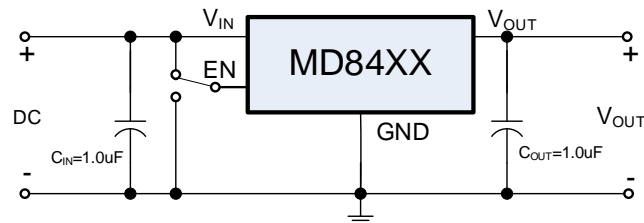

■ Notes on Use

Input Capacitor (C_{IN}): 1.0 μF above

Output Capacitor (C_{OUT}): 1.0 μF above

■ Electrical Characteristics

MD84XX Series (Unless otherwise indicated: $T_a=25^\circ\text{C}$)

| PARAMETER | SYMBOL | CONDITIONS | MIN. | TYP. | MAX. | UNIT |
|------------------------------------|---|--|---------------------------------|--------------|-------------------------|-----------------------|
| Output Voltage*1 | $V_{OUT(S)}$ | $V_{IN}=V_{OUT(S)}+2V, I_{OUT}=10\text{mA}$ | $V_{OUT(S)}\times 0.98$ | $V_{OUT(S)}$ | $V_{OUT(S)}\times 1.02$ | V |
| Dropout Voltage*2 | V_{DROP} | $V_{EN}=V_{IN}, V_{OUT(S)}=3.3V$ $I_{OUT}=1\text{mA}$ | | 4 | 8 | mV |
| | | $V_{EN}=V_{IN}, V_{OUT(S)}=3.3V$ $I_{OUT}=300\text{mA}$ | | 1300 | 1950 | |
| Line Regulation | $\frac{\Delta V_{OUT}}{\Delta V_{IN} \cdot V_{OUT(S)}}$ | $V_{OUT(S)}+2V \leq V_{IN} \leq 40V$ $I_{OUT}=1\text{mA}$ | | 0.01 | 0.02 | %/V |
| Load Regulation | ΔV_{OUT2} | $V_{IN}=V_{OUT(S)}+2V$ $1\text{mA} \leq I_{OUT} \leq 300\text{mA}$ | $V_{OUT(S)} \leq 5.3V$ | 20 | 40 | mV |
| | | | $V_{OUT(S)} > 5.3V$ | 50 | 80 | |
| Temperature Stability | $\frac{\Delta V_{OUT}}{\Delta T_a \cdot V_{OUT(S)}}$ | $V_{IN}=V_{OUT(S)}+2V, I_{OUT}=10\text{mA}$ $-40^\circ\text{C} \leq T_a \leq 125^\circ\text{C}$ | | ± 50 | | ppm/ $^\circ\text{C}$ |
| GND Current ($V_{EN}=V_{IN}$) | I_{GND} | no load | $V_{OUT(S)} < 3.0V$ | 0.8 | 1.2 | 2 |
| | | | $3.0 \leq V_{OUT(S)} \leq 5.3V$ | 1 | 1.5 | 2.5 |
| | | | $V_{OUT(S)} > 5.3V$ | 1.5 | 2.3 | 3.5 |
| | | | $I_{OUT}=100\text{mA}$ | | 460 | |
| Shutdown Current ($V_{EN}=0$) | I_{SHUT} | $V_{IN}=30.0V, V_{EN}=0$ | | 0.01 | 0.1 | |
| Input Voltage | V_{IN} | --- | 2.2 | | 40 | V |
| Maximum Output Current | I_{OUTMAX} | | 300 | 350 | | mA |
| Current Limit*3 | I_{LIM} | $V_{IN}=V_{OUT(S)}+2V,$ $V_{OUT}=0.95 \times V_{OUT(S)}$ | 350 | 550 | | |
| Short Circuit Current*4 | I_{SHORT} | $V_{IN}=V_{EN}=V_{OUT(S)}+2.0V$ $V_{OUT}=0V$ | | 65 | | |
| Power Supply Rejection Ratio | PSRR | $f=10\text{Hz}, V_{OUT(S)}=3.3V$ | | 74 | | dB |
| | | $f=100\text{Hz}, V_{OUT(S)}=3.3V$ | | 63 | | |
| | | $f=1\text{kHz}, V_{OUT(S)}=3.3V$ | | 42 | | |
| EN 'H' Level Voltage | V_{ENH} | | 1.5 | | 40.0 | V |
| EN 'L' Level Voltage | V_{ENL} | | 0 | | 0.6 | |
| EN 'H' Level Current | I_{ENH} | $V_{IN}=40V, V_{EN}=V_{IN}$ | -0.1 | | 0.1 | uA |
| EN 'L' Level Voltage | I_{ENL} | $V_{IN}=40V, V_{EN}=0$ | -0.1 | | 0.1 | |
| Over Temperature Protection | OTP | $I_{OUT}=1\text{mA}$ | | 170 | | $^\circ\text{C}$ |

Notes:

- $V_{OUT(S)}$: Output voltage when $V_{IN}=V_{OUT}+2V, I_{OUT}=1\text{mA}$.
- $V_{DROP}=V_{IN1} - (V_{OUT(S)} \times 0.98)$ where V_{IN1} is the input voltage when $V_{OUT} = V_{OUT(S)} \times 0.98$.
- I_{LIM} : Output current when $V_{IN}=V_{OUT(S)}+2V$ and $V_{OUT} = 0.95 \times V_{OUT(S)}$.
- V_{OUT} pin should be shorted to GND pin, and the impedance between them is less than 0.1 ohm.

■ Typical Performance Characteristics

Test Conditions: $V_{IN}=V_{OUT}+2.0V$, $C_{IN}=1.0\mu F$, $C_{OUT}=1.0\mu F$, $T_a=25^\circ C$, unless otherwise indicated.

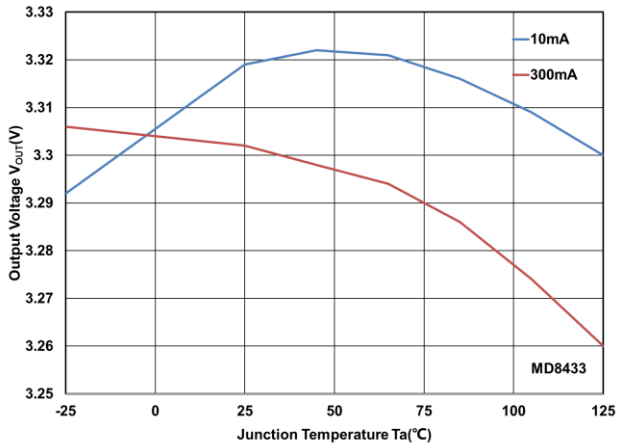

V_{OUT} vs Temperature

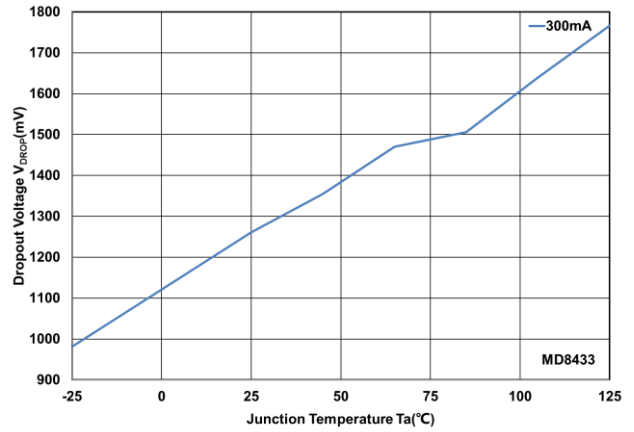

V_{DROP} vs Temperature

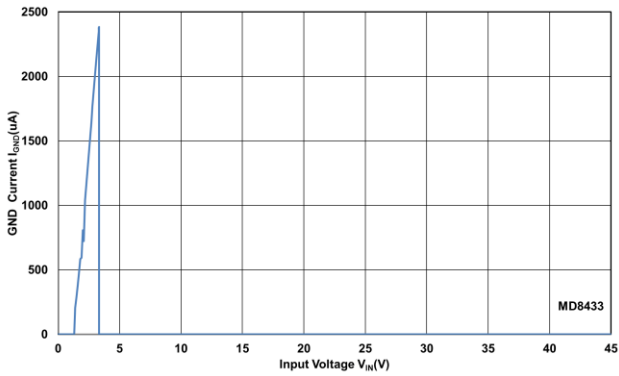

GND Current vs Input Voltage

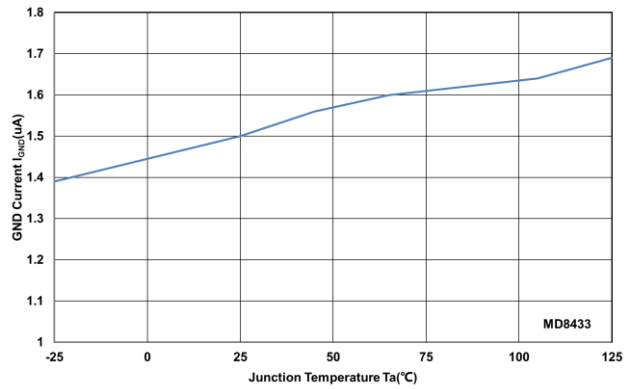

GND Current vs Temperature

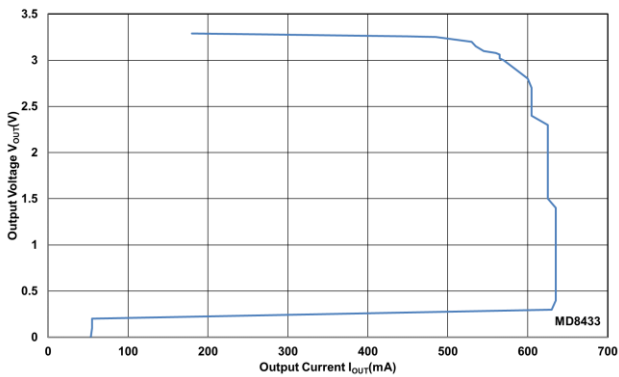

Output Current Fold-back

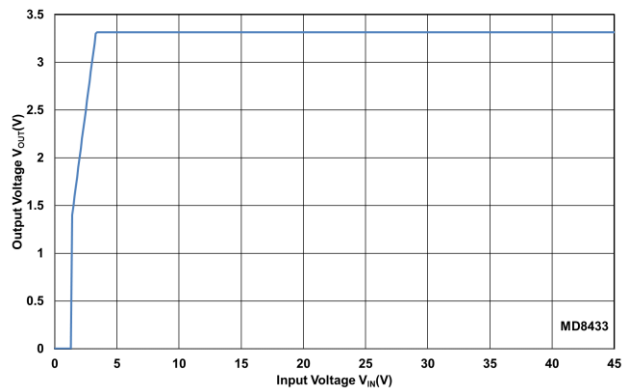

Output Voltage vs Input Voltage

■ Typical Performance Characteristics (Continued)

Test Conditions: $V_{IN}=V_{OUT}+2.0V$, $C_{IN}=1.0\mu F$, $C_{OUT}=1.0\mu F$, unless otherwise indicated.

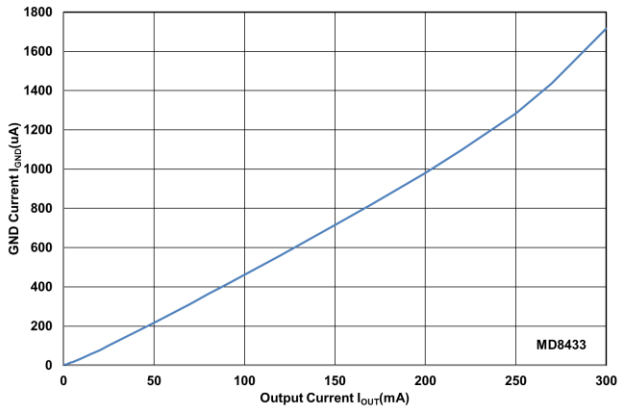

GND Current vs Output Current

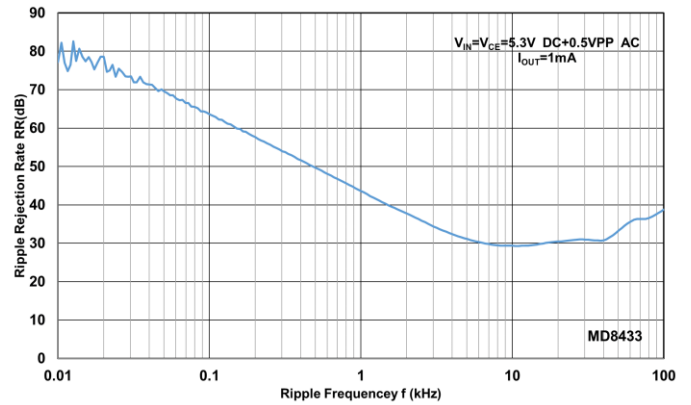

Power Supply Rejection Ratio

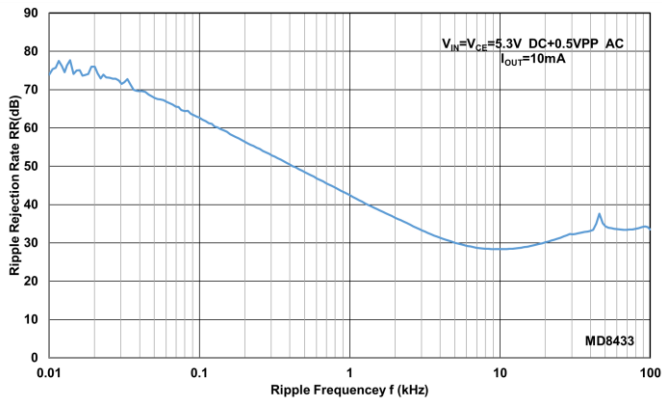

Power Supply Rejection Ratio

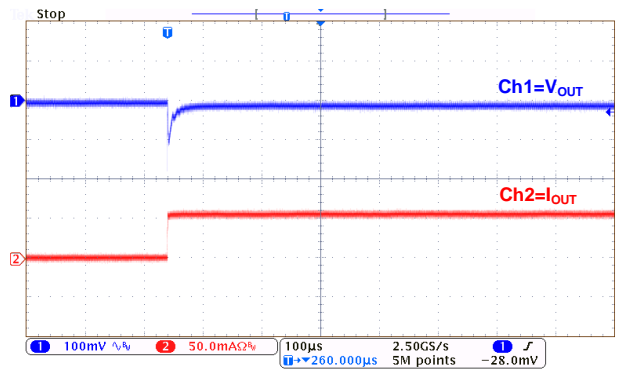

Load Transient:
MD8433($I_{OUT}=0mA\sim 50mA$)

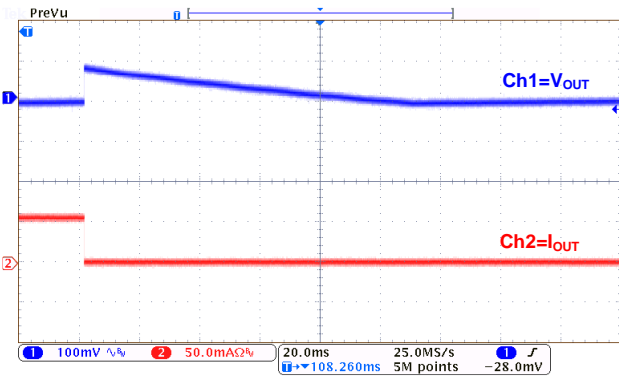

Load Transient:
MD8433($I_{OUT}=50mA\sim 0mA$)

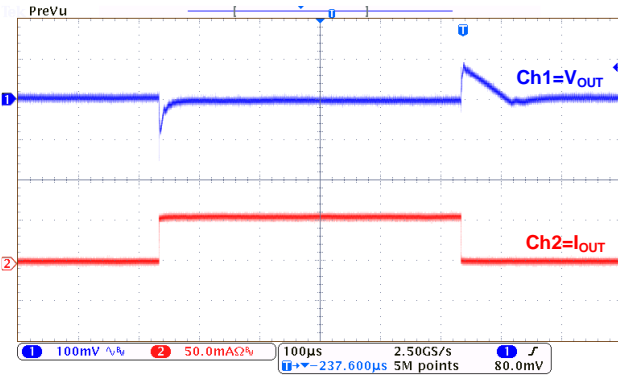

Load Transient:
MD8433($I_{OUT}=1mA\sim 50mA\sim 1mA$)

■ Typical Performance Characteristics (Continued)

Test Conditions: $V_{IN}=V_{OUT}+2.0V$, $C_{IN}=1.0\mu F$, $C_{OUT}=1.0\mu F$, $T_a=25^\circ C$, unless otherwise indicated.

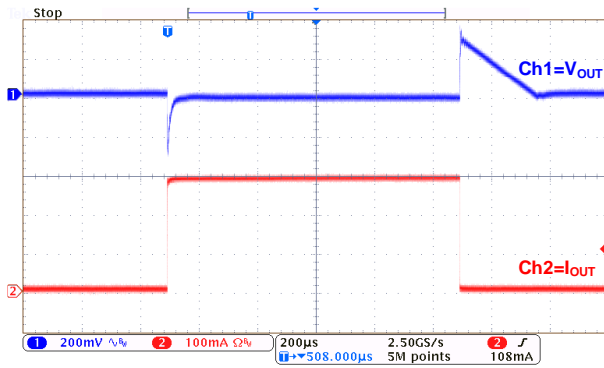

Load Transient:
MD8433($I_{OUT}=1mA \sim 300mA \sim 1mA$)

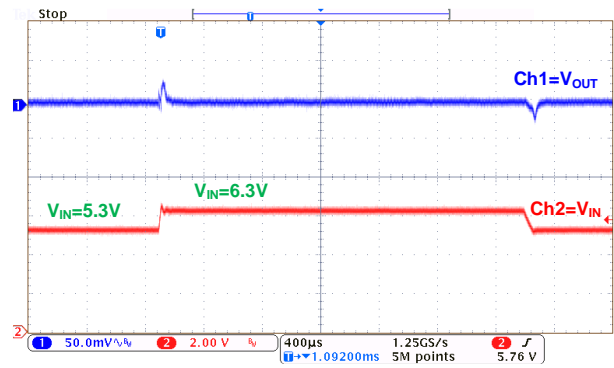

Line Transient:
MD8433($I_{OUT}=1mA$)

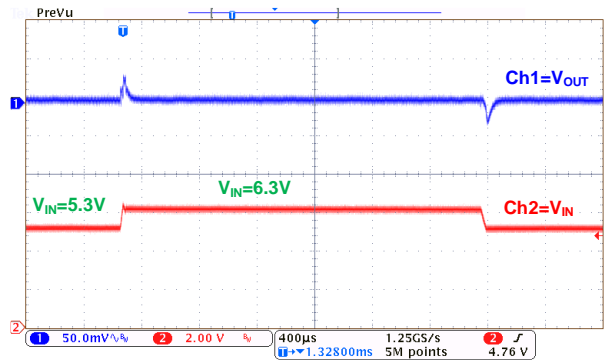

Line Transient:
MD8433($I_{OUT}=10mA$)

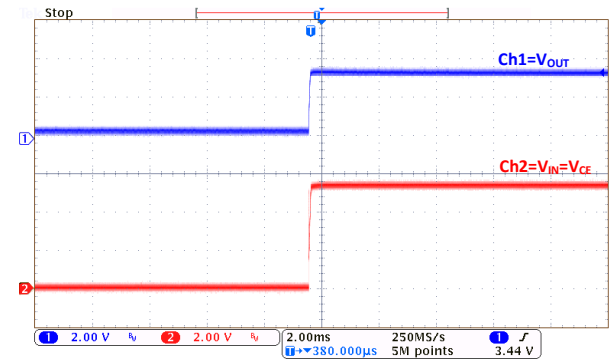

Power-Up:
MD8433($I_{OUT}=0mA$)

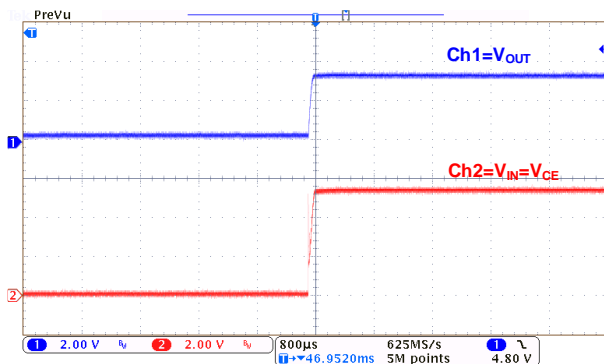

Power-Up:
MD8433($I_{OUT}=300mA$)

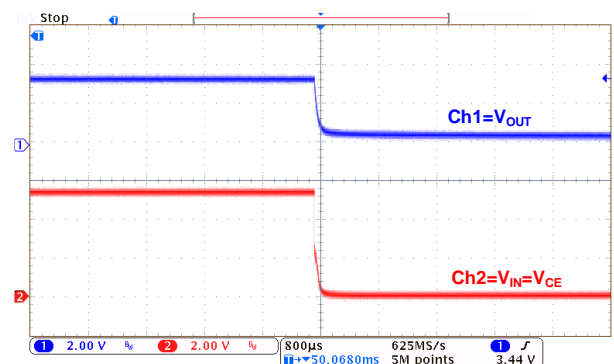

Power-Down:
MD8433($I_{OUT}=0mA$)

■ Typical Performance Characteristics (Continued)

Test Conditions: $V_{IN}=V_{OUT}+2.0V$, $C_{IN}=1.0\mu F$, $C_{OUT}=1.0\mu F$, $T_a=25^\circ C$, unless otherwise indicated.

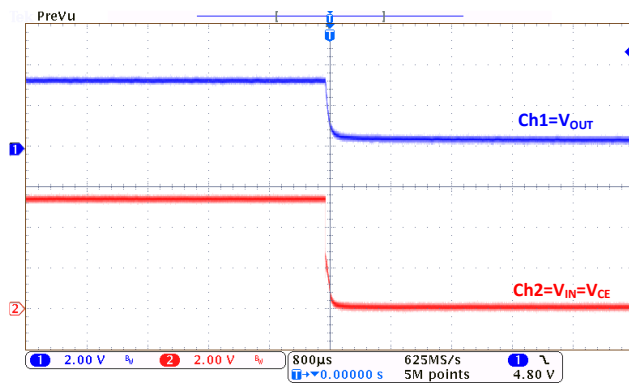

Power-Down:
MD8433($I_{OUT}=300mA$)

■ Operational Explanation

1. Output voltage control

The voltage divided by resistors R1 and R2 is compared with the internal reference voltage by the error amplifier. The amplifier output then drives the P-channel MOSFET connected to the V_{OUT} pin. The output voltage at the V_{OUT} pin is regulated by this negative feedback system. The current limit circuit and short protect circuit operate in relation to output current level. Further, the IC's internal circuitry can be in operation or shutdown modes controlled by the EN pin's signal.

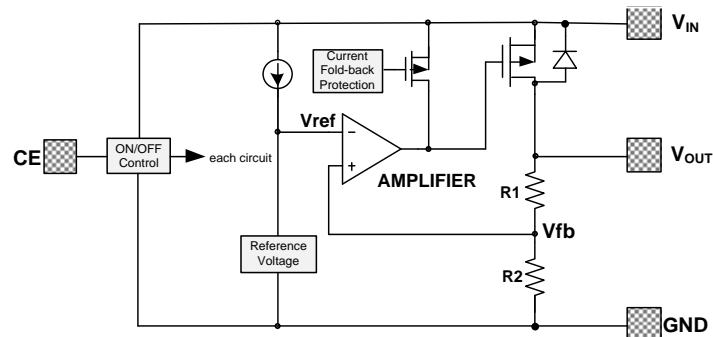

2. Pass transistor

The pass transistor with low turn-on resistance used in MD84XX is a P-channel MOSFET. If the potential on V_{OUT} pin is higher than V_{IN} , it is possible that IC will be destroyed due to reverse current which is caused by parasitic diodes between V_{IN} and V_{OUT} . Therefore, the V_{OUT} pin potential exceeds $V_{IN}+0.3V$ is not allowed.

3. Current foldback and over temperature protection

The MD84XX series includes a combination of a fixed current limiter circuit and a foldback circuit, which aid the operations of the current limiter and circuit protection. When the load current reaches the current limit level, the fixed current limiter circuit operates and output voltage drops. As a result of this drop in output voltage, the foldback circuit operates, output voltage drops further and output current decreases. This design can prevent the chip be damaged due to over temperature, moreover, the heat dissipation is limited by the package type.

Special attention should be paid to that the product of the dropout voltage on the chip and the output current must be smaller than the heat dissipation. If power consumption on the chip is more than the heat dissipation, OTP will protect the chip from damaging due to over temperature.

■ Notes:

1. The input and output capacitors should be placed as close as possible to the IC.
2. If the impedance of the power supply is high, which is caused by forgetting installing input capacitor or installing too small value capacitor, the oscillation may occur.
3. Pay attention to the operation conditions of input and output voltage and load current, such that the power consumption in the IC should not exceed the allowable power consumption of the package even though the chip has short circuit protection.
4. IC has a built-in anti-static protection (ESD) circuit, but please do not add excessive stress to the IC.

■ Packaging Information

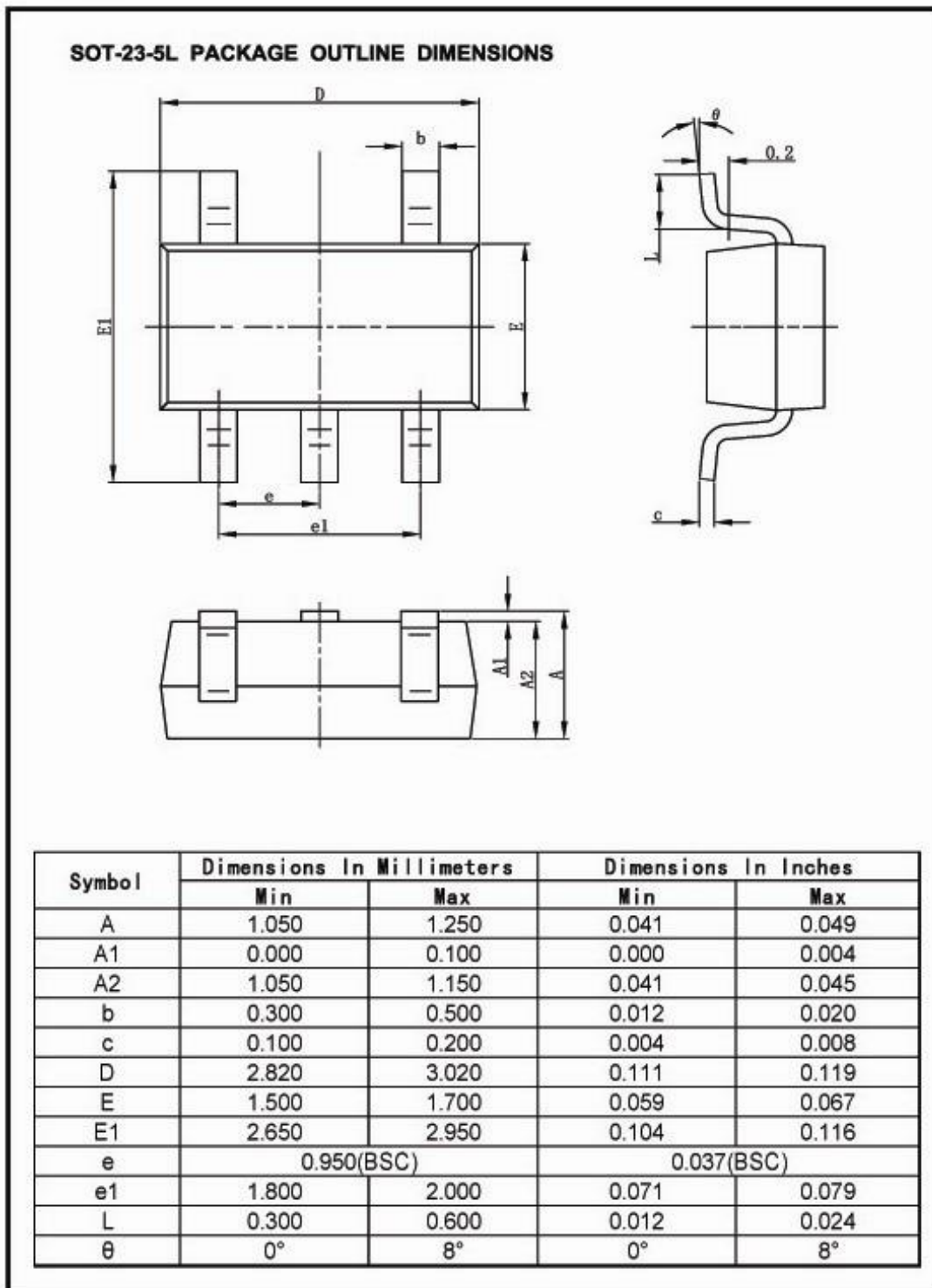

■ Packaging Information (Continued)

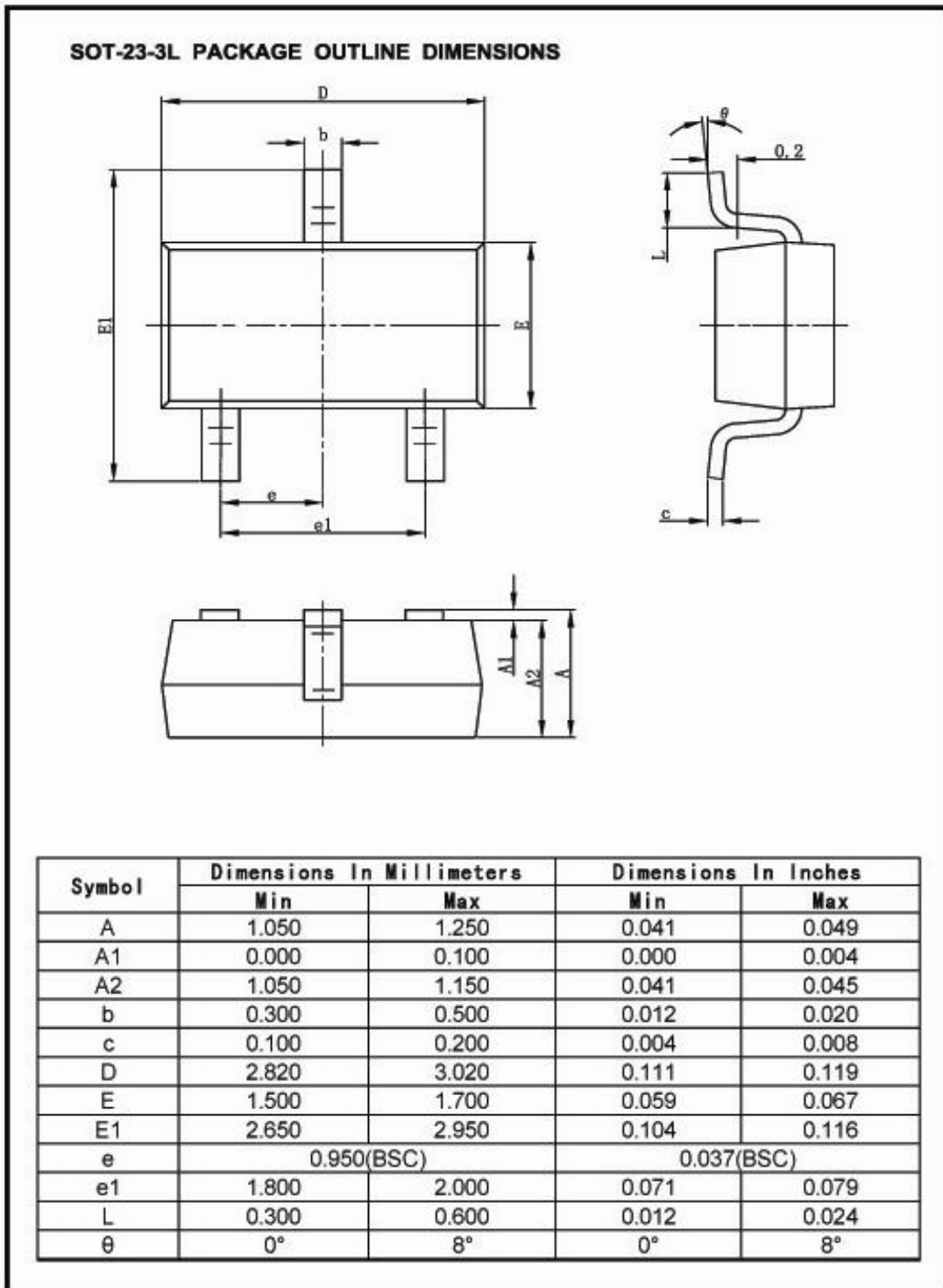

■ Packaging Information (Continued)

DFN(2*2)-6L PACKAGE OUTLINE DIMENSIONS

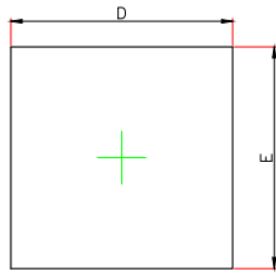

TOP VIEW

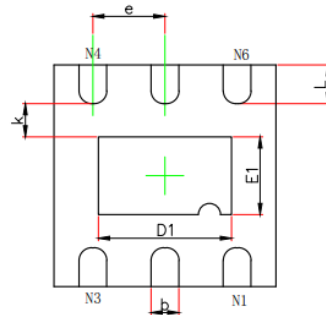

BOTTOM VIEW

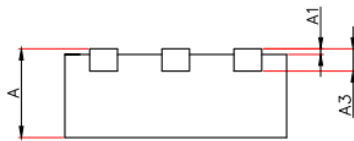

SIDE VIEW

| Symbol | Dimensions In Millimeters | | Dimensions In Inches | |
|--------|---------------------------|-------------|----------------------|-------------|
| | Min. | Max. | Min. | Max. |
| A | 0.700/0.800 | 0.800/0.900 | 0.028/0.031 | 0.031/0.035 |
| A1 | 0.000 | 0.050 | 0.000 | 0.002 |
| A3 | 0.203REF. | | 0.008REF. | |
| D | 1.924 | 2.076 | 0.076 | 0.082 |
| E | 1.924 | 2.076 | 0.075 | 0.083 |
| D1 | 1.100 | 1.300 | 0.043 | 0.051 |
| E1 | 0.600 | 0.800 | 0.024 | 0.031 |
| k | 0.200MIN. | | 0.008MIN. | |
| b | 0.200 | 0.300 | 0.007 | 0.012 |
| e | 0.650TYP. | | 0.026TYP. | |
| L | 0.274 | 0.426 | 0.011 | 0.017 |

■ Packaging Information (Continued)

DFN(1.6*1.6)-6L PACKAGE OUTLINE DIMENSIONS

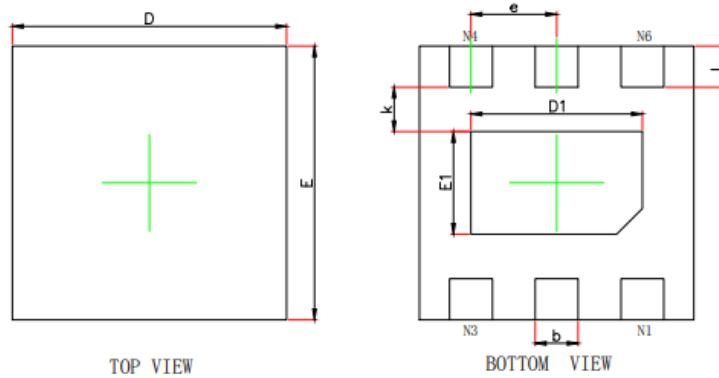

| Symbol | Dimensions In Millimeters | | Dimensions In Inches | |
|--------|---------------------------|-------------|----------------------|-------------|
| | Min. | Max. | Min. | Max. |
| A | 0.450/0.550 | 0.550/0.650 | 0.018/0.022 | 0.022/0.026 |
| A1 | 0.000 | 0.050 | 0.000 | 0.002 |
| A3 | 0.152REF. | | 0.006REF. | |
| D | 1.550 | 1.650 | 0.061 | 0.065 |
| E | 1.550 | 1.650 | 0.061 | 0.065 |
| E1 | 0.500 | 0.700 | 0.020 | 0.028 |
| D1 | 0.900 | 1.100 | 0.035 | 0.043 |
| k | 0.200MIN. | | 0.008REF. | |
| b | 0.200 | 0.300 | 0.008 | 0.012 |
| e | 0.500BSC. | | 0.020BSC. | |
| L | 0.164 | 0.316 | 0.006 | 0.012 |

■ Packaging Information (Continued)

TO252-4L PACKAGE OUTLINE DIMENSIONS

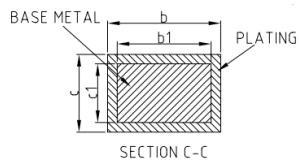
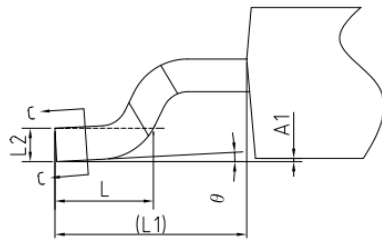
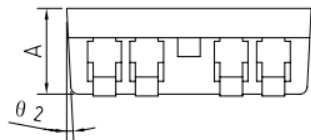
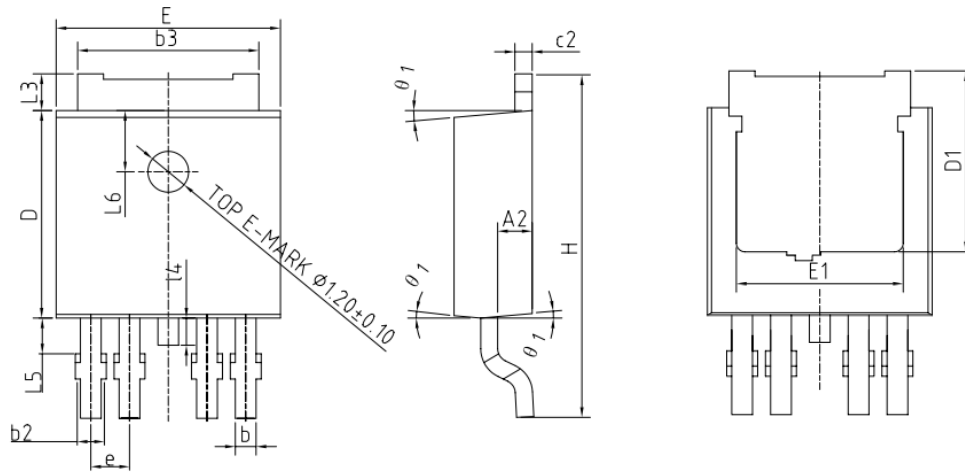

COMMON DIMENSIONS
(UNITS OF MEASURE=MILLIMETER)

| SYMBOL | MIN | NOM | MAX |
|------------|---------|-------|-------|
| A | 2.20 | 2.30 | 2.38 |
| A1 | 0 | — | 0.10 |
| A2 | 0.90 | 1.00 | 1.10 |
| b | 0.57 | — | 0.70 |
| b1 | 0.56 | 0.61 | 0.66 |
| b2 | 0.57 | — | 0.86 |
| b3 | 5.23 | 5.33 | 5.44 |
| c | 0.50 | — | 0.56 |
| c1 | 0.50 | 0.51 | 0.52 |
| c2 | 0.50 | — | 0.56 |
| D | 6.00 | 6.10 | 6.20 |
| D1 | 5.00 | — | — |
| E | 6.50 | 6.60 | 6.70 |
| E1 | 4.70 | — | — |
| e | 1.14BSC | | |
| H | 9.80 | 10.10 | 10.40 |
| L | 1.40 | 1.50 | 1.70 |
| L1 | 2.90REF | | |
| L2 | 0.51BSC | | |
| L3 | 0.90 | — | 1.25 |
| L4 | 0.60 | 0.80 | 1.00 |
| L5 | 0.90 | — | 1.50 |
| L6 | 1.80REF | | |
| θ | 0° | — | 8° |
| $\theta 1$ | 3° | 5° | 7° |
| $\theta 2$ | 1° | 3° | 5° |

■ Packaging Information (Continued)

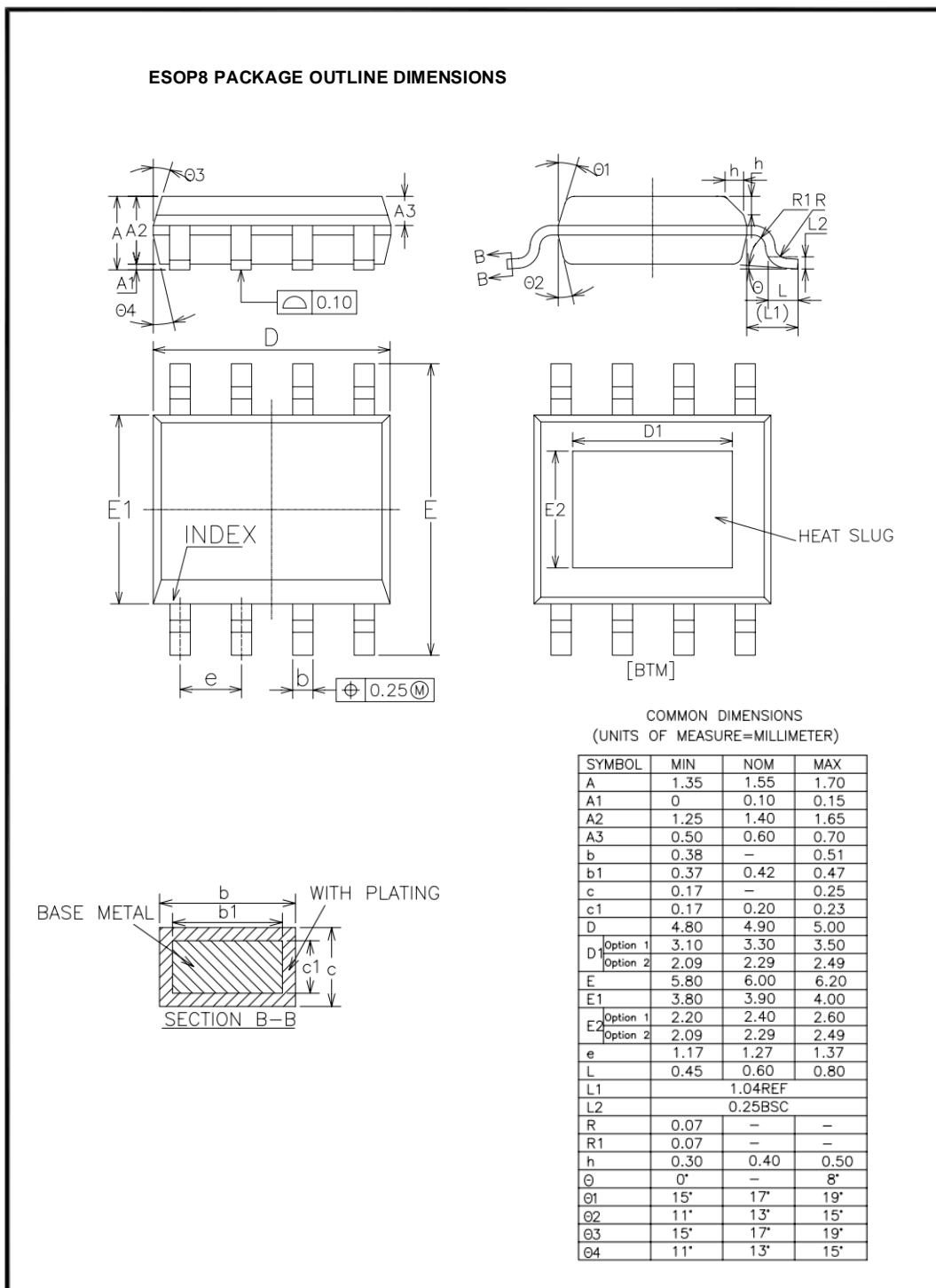

For the newest datasheet, please see the website:

www.md-ic.com.cn

Version V1.8: 20210930

X-ON Electronics

Largest Supplier of Electrical and Electronic Components

Click to view similar products for [Linear Voltage Regulators](#) category:

Click to view products by [Mingda](#) manufacturer:

Other Similar products are found below :

[LV5684PVD-XH](#) [MCDTSA6-2R](#) [L7815ACV-DG](#) [714954EB](#) [ZMR500QFTA](#) [BA033LBSG2-TR](#) [LV5680P-E](#) [L79M05T-E](#) [L78LR05D-MA-E](#) [NCV317MBTG](#) [NTE7227](#) [MP2018GZD-33-P](#) [MP2018GZD-5-P](#) [LV5680NPVC-XH](#) [LT1054CN8](#) [ZTS6538SE](#) [UA78L09CLP](#) [UA78L09CLPR](#) [CAT6221-PPTD-GT3](#) [MC78M09CDTRK](#) [NCV51190MNTAG](#) [78M05](#) [HT7150-1](#) [UM1540DB-18](#) [XC6234H281VR-G](#) [WL2834CA-6/TR](#) [TPL730F33-5TR](#) [TLS850F1TA](#) [V50](#) [TPS549B22RVFR](#) [UM1540DB-33](#) [WL9200P3-50B](#) [WL9100P3-33B](#) [WL9005D4-33](#) [XC6219B152MR](#) [WL2855K33-3/TR](#) [PJ54BM33SE](#) [PJ9500M25SA](#) [MD7218E33PC1](#) [H7533-2PR](#) [SK7812AU](#) [SD1A30](#) [78L33](#) [TP78L33T3](#) [L78L33ACUTR](#) [SK6513ST3A-50](#) [SK6054D4-09](#) [SK6054D4-18](#) [SK6054D4-11](#) [SK6054D4-10](#) [LM79L12F](#)