



MD84XX is a high voltage (up to 40V) low power low dropout voltage regulator (LDO) manufactured in CMOS processes. It can deliver up to 300mA of current while consuming only 1.5uA of quiescent current. It consists of a reference voltage generator, an error amplifier, a current foldback circuit, and a phase compensation circuit plus a driver transistor.

■ Features

- Ultra-low Quiescent Current: 1.5uA
- Maximum Input Voltage: 40V
- Output Voltage Highly Accurate: $\pm 2\%$
- Maximum Output Current: 300mA
- Dropout Voltage: 4mV@I_{OUT}=1mA
- Temperature Stability: ± 50 ppm/°C
- ON/OFF Logic = Enable High
- Protections Circuits: Current Limiter, Foldback, Thermal shutdown
- Output Capacitor: Low ESR Ceramic Capacitor Compatible

■ Applications

- Smart wearer
- Long-life battery-powered devices
- Portable mobile devices, such as mobile phones, cameras, and so on
- Wireless communication equipment

■ Product Selections

Type	Output Voltage (note 1*)	Current Limit	Accuracy	Package (note 2*)	MARKING (note 3*)
MD8425	2.5V	550mA	$\pm 2\%$	SOT23-5\SOT23-3	8425 8425M
MD8427	2.7V	550mA	$\pm 2\%$	SOT23-5	8427M
MD8428	2.8V	550mA	$\pm 2\%$	SOT23-5\SOT23-3	8428
MD8430	3.0V	550mA	$\pm 2\%$	SOT23-5\SOT23-3	8430 8430M
MD8433	3.3V	550mA	$\pm 2\%$	SOT23-5\SOT23-3 TO252-4	8433 8433S 8433M 8433Q
MD8436	3.6V	550mA	$\pm 2\%$	SOT23-5\SOT23-3	8436 8436M
MD8440	4.0V	550mA	$\pm 2\%$	SOT23-5\SOT23-3	8440 8440M
MD8445	4.5V	550mA	$\pm 2\%$	SOT23-5	8445Q
MD8450	5.0V	550mA	$\pm 2\%$	SOT23-5\SOT23-3 DFN(2*2)-6\ESOP8 DFN(1.6*1.6)-6	8450 8450M
MD8465	6.5V	550mA	$\pm 2\%$	SOT23-3	8465
MD8410	10V	550mA	$\pm 2\%$	SOT23-5	8410
MD8412	12V	550mA	$\pm 2\%$	SOT23-5\ESOP8	8412

Notes:

1* Customer can request to customize the output voltage ranged from 1.2V to 15V if desired voltage is not found in the selections.

2* Customer can request customization of package choice.

3* Please pay attention to the MARKING of the product package type.

Pin Configuration and Functions

**SOT23-5
Top View**

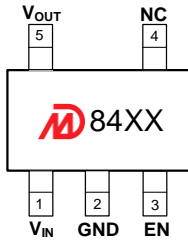

**SOT23-5(S_Type)
Top View**

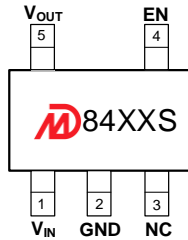

**SOT23-5(M_Type)
Top View**

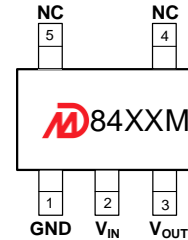

**SOT23-5(Q_Type)
Top View**



**SOT23-3
Top View**

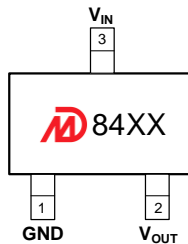

**TO252-4
Top View**



**ESOP8
Top View**

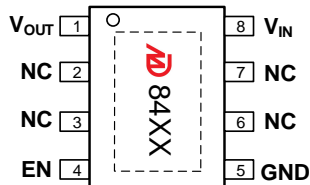

**DFN(1.6*1.6)-6
Top View**

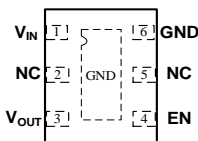

**DFN(2*2)-6
Top View**

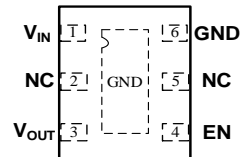

Pin Functions

NAME	DESCRIPTION
V _{IN}	Power Input Pin.
EN	Enable pin. Drive this pin high to enable the device. Drive this pin low to put the device into low current shutdown.
V _{OUT}	Regulated output voltage pin
GND	Ground
Thermal pad	The thermal pad is electrically connected to the GND node. Connect this pad to the GND plane for improved thermal performance.
NC	No internal connection

■ Absolute Maximum Ratings (Unless otherwise indicated: $T_a=25^\circ\text{C}$)

PARAMETER	SYMBOL	RATINGS		UNITS
Input Voltage	V_{IN}	-0.3 ~ 45		V
Output Voltage	V_{OUT}	$V_{SS}-0.3 \sim V_{IN}+0.3V$		
Power Dissipation	P_D	SOT23-5	250	mW
		SOT23-3	250	
		ESOP8	1800	
		TO-252	1800	
Thermal Resistance	$R_{\theta JB}^{(1)}$	SOT23-5	180	$^\circ\text{C/W}$
		SOT23-3	200	
		ESOP8	80	
		TO-252	60	
Operating Ambient Temperature	T_{opr}	-40 ~ +85		$^\circ\text{C}$
Storage Temperature	T_{stg}	-40 ~ +125		
ESD Protection	ESD HBM	2000		V
Moisture Sensitivity Level	MSL	3		

Note: Stresses above those listed under "Absolute Maximum Ratings" may cause permanent damage to the device.

⁽¹⁾ Mounted on JEDEC standard 4layer (2s2p) PCB test board

■ Typical Applications

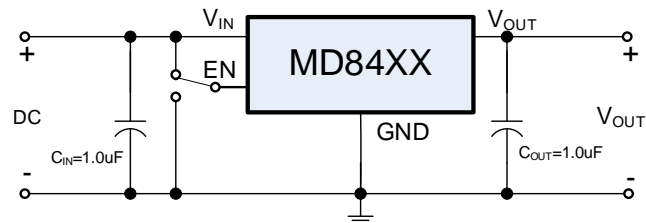

■ Notes on Use

Input Capacitor (C_{IN}): 1.0 μF above

Output Capacitor (C_{OUT}): 1.0 μF above

■ Electrical Characteristics

MD84XX Series (Unless otherwise indicated: $T_a=25^{\circ}\text{C}$)

PARAMETER	SYMBOL	CONDITIONS	MIN.	TYP.	MAX.	UNIT
Output Voltage*1	$V_{OUT(S)}$	$V_{IN}=V_{OUT(S)}+2V, I_{OUT}=10\text{mA}$	$V_{OUT(S)} \times 0.98$	$V_{OUT(S)}$	$V_{OUT(S)} \times 1.02$	V
Dropout Voltage*2	V_{DROP}	$V_{EN}=V_{IN}, V_{OUT(S)}=3.3V$ $I_{OUT}=1\text{mA}$		4	8	mV
		$V_{EN}=V_{IN}, V_{OUT(S)}=3.3V$ $I_{OUT}=300\text{mA}$		1300	1950	
Line Regulation	$\frac{\Delta V_{OUT}}{\Delta V_{IN} \cdot V_{OUT(S)}}$	$V_{OUT(S)}+2V \leq V_{IN} \leq 40V$ $I_{OUT}=1\text{mA}$		0.01	0.02	%/V
Load Regulation	ΔV_{OUT2}	$V_{IN}=V_{OUT(S)}+2V$ $1\text{mA} \leq I_{OUT} \leq 300\text{mA}$	$V_{OUT(S)} \leq 5.3V$	20	40	mV
			$V_{OUT(S)} > 5.3V$	50	80	
Temperature Stability	$\frac{\Delta V_{OUT}}{\Delta T_a \cdot V_{OUT(S)}}$	$V_{IN}=V_{OUT(S)}+2V, I_{OUT}=10\text{mA}$ $-40^{\circ}\text{C} \leq T_a \leq 125^{\circ}\text{C}$		± 50		ppm/°C
GND Current ($V_{EN}=V_{IN}$)	I_{GND}	no load	$V_{OUT(S)} < 3.0V$	0.8	1.2	2
			$3.0 \leq V_{OUT(S)} \leq 5.3V$	1	1.5	2.5
			$V_{OUT(S)} > 5.3V$	1.5	2.3	3.5
			$I_{OUT}=100\text{mA}$		460	
Shutdown Current ($V_{EN}=0$)	I_{SHUT}	$V_{IN}=30.0V, V_{EN}=0$		0.01	0.1	
Input Voltage	V_{IN}	---	2.2		40	V
Maximum Output Current	I_{OUTMAX}		300	350		mA
Current Limit*3	I_{LIM}	$V_{IN}=V_{OUT(S)}+2V,$ $V_{OUT}=0.95 \times V_{OUT(S)}$	350	550		
Short Circuit Current*4	I_{SHORT}	$V_{IN}=V_{EN}=V_{OUT(S)}+2.0V$ $V_{OUT}=0V$		65		
Power Supply Rejection Ratio	PSRR	$f=10\text{Hz}, V_{OUT(S)}=3.3V$		74		dB
		$f=100\text{Hz}, V_{OUT(S)}=3.3V$		63		
		$f=1\text{kHz}, V_{OUT(S)}=3.3V$		42		
EN 'H' Level Voltage	V_{ENH}		1.5		40.0	V
EN 'L' Level Voltage	V_{ENL}		0		0.6	
EN 'H' Level Current	I_{ENH}	$V_{IN}=40V, V_{EN}=V_{IN}$	-0.1		0.1	uA
EN 'L' Level Voltage	I_{ENL}	$V_{IN}=40V, V_{EN}=0$	-0.1		0.1	
Over Temperature Protection	OTP	$I_{OUT}=1\text{mA}$		170		°C

Notes:

- $V_{OUT(S)}$: Output voltage when $V_{IN}=V_{OUT}+2V, I_{OUT}=1\text{mA}$.
- $V_{DROP}=V_{IN1} - (V_{OUT(S)} \times 0.98)$ where V_{IN1} is the input voltage when $V_{OUT} = V_{OUT(S)} \times 0.98$.
- I_{LIM} : Output current when $V_{IN}=V_{OUT(S)}+2V$ and $V_{OUT} = 0.95 \times V_{OUT(S)}$.
- V_{OUT} pin should be shorted to GND pin, and the impedance between them is less than 0.1 ohm.

■ Typical Performance Characteristics

Test Conditions: $V_{IN}=V_{OUT}+2.0V$, $C_{IN}=1.0\mu F$, $C_{OUT}=1.0\mu F$, $T_a=25^\circ C$, unless otherwise indicated.

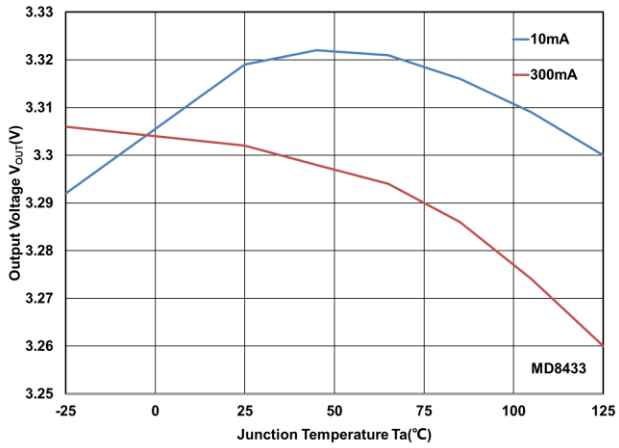

V_{OUT} vs Temperature

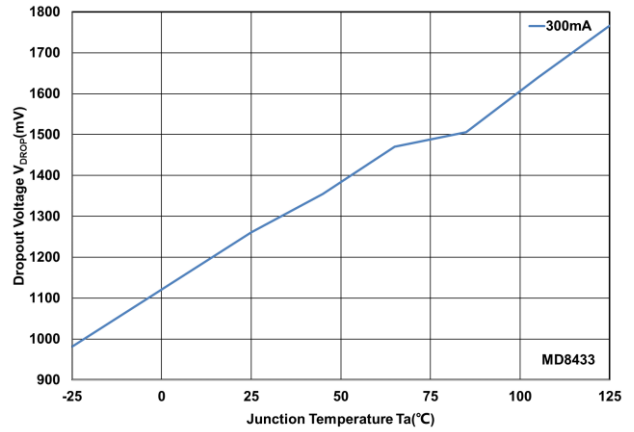

V_{DROP} vs Temperature

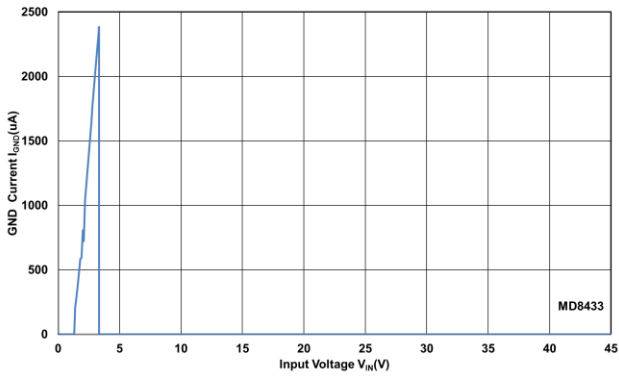

GND Current vs Input Voltage

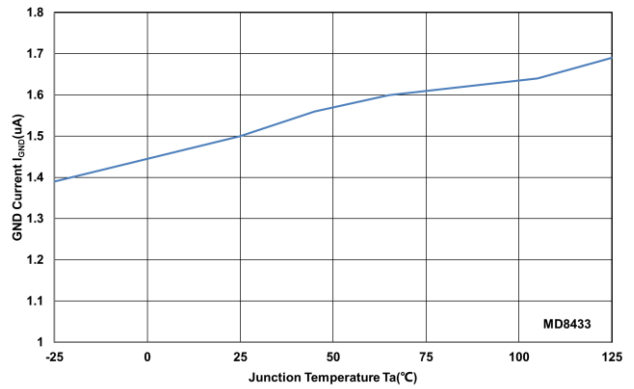

GND Current vs Temperature

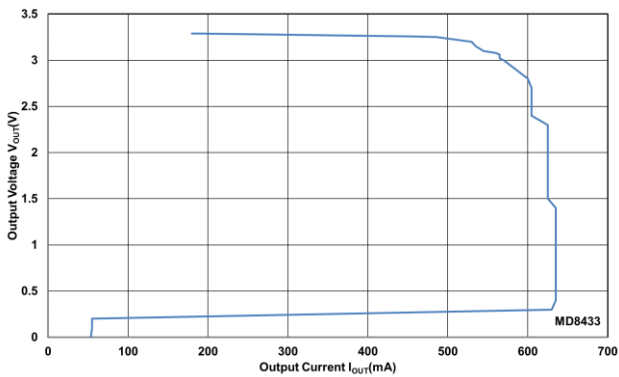

Output Current Fold-back

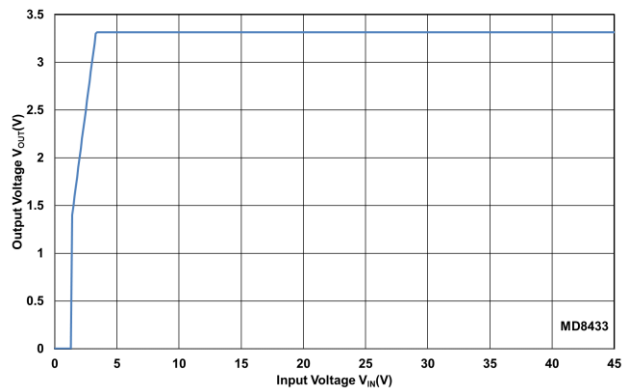

Output Voltage vs Input Voltage

■ Typical Performance Characteristics (Continued)

Test Conditions: $V_{IN}=V_{OUT}+2.0V$, $C_{IN}=1.0\mu F$, $C_{OUT}=1.0\mu F$, unless otherwise indicated.

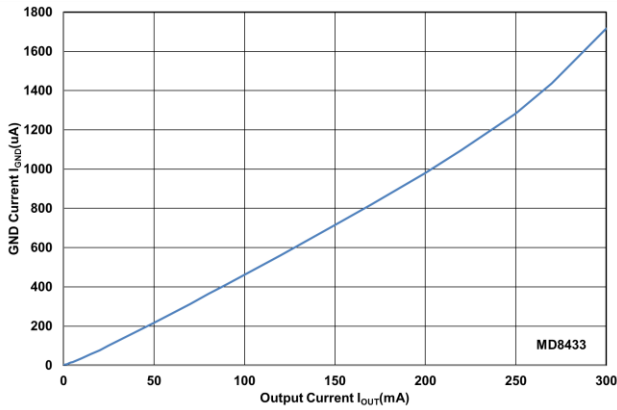

GND Current vs Output Current

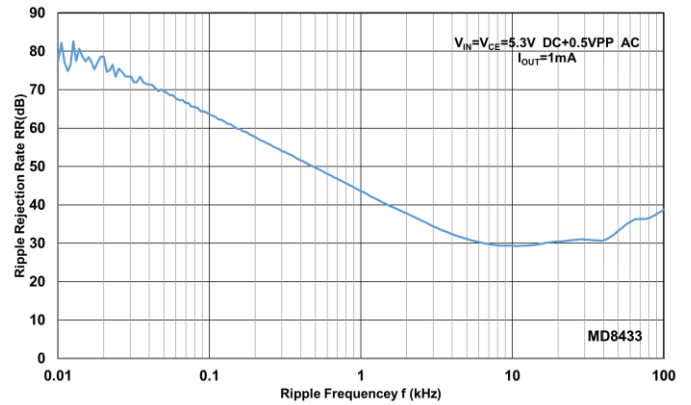

Power Supply Rejection Ratio

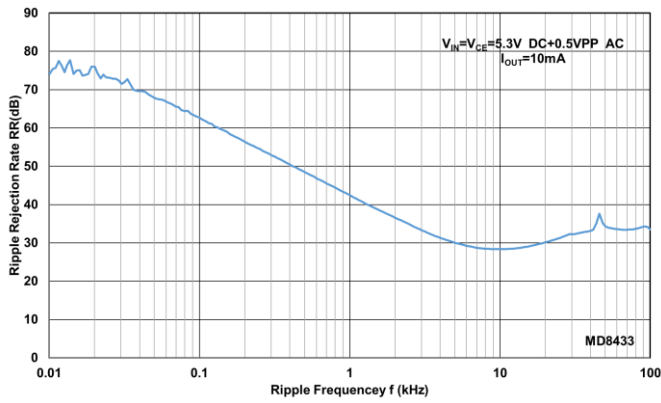

Power Supply Rejection Ratio

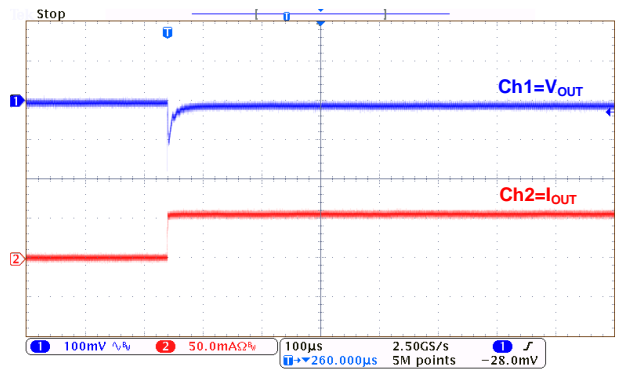

Load Transient:
MD8433($I_{OUT}=0mA\sim 50mA$)

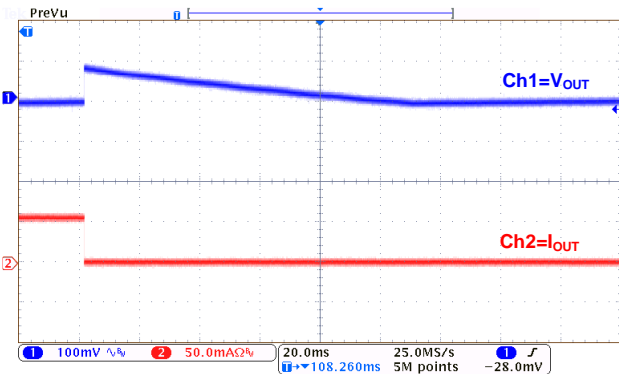

Load Transient:
MD8433($I_{OUT}=50mA\sim 0mA$)

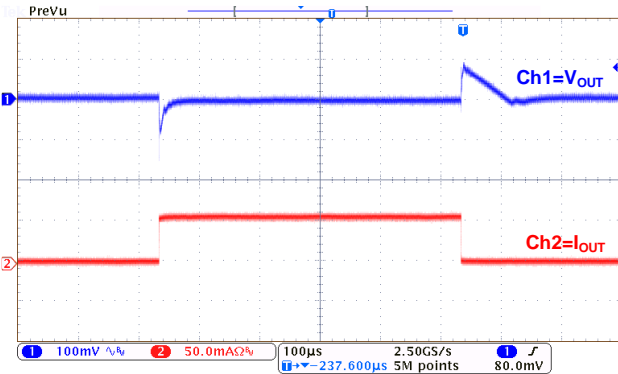

Load Transient:
MD8433($I_{OUT}=1mA\sim 50mA\sim 1mA$)

■ Typical Performance Characteristics (Continued)

Test Conditions: $V_{IN}=V_{OUT}+2.0V$, $C_{IN}=1.0\mu F$, $C_{OUT}=1.0\mu F$, $T_a=25^\circ C$, unless otherwise indicated.

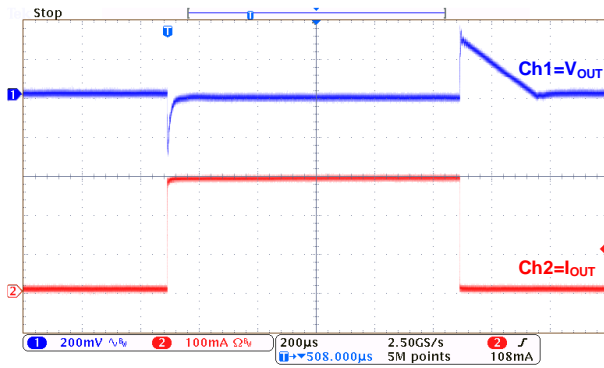

Load Transient:
MD8433($I_{OUT}=1mA\sim 300mA\sim 1mA$)

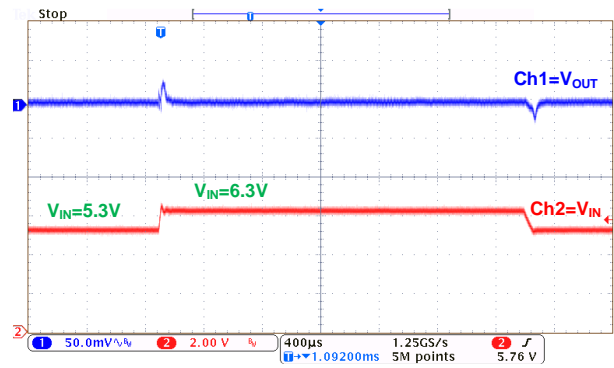

Line Transient:
MD8433($I_{OUT}=1mA$)

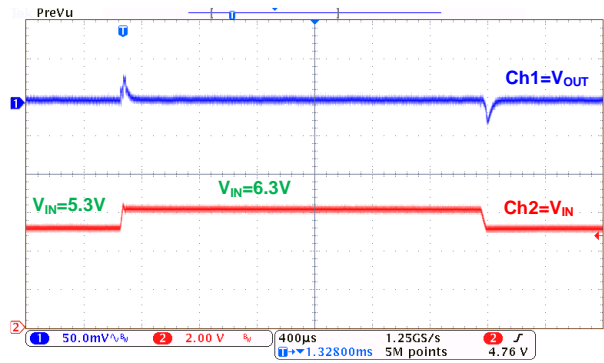

Line Transient:
MD8433($I_{OUT}=10mA$)

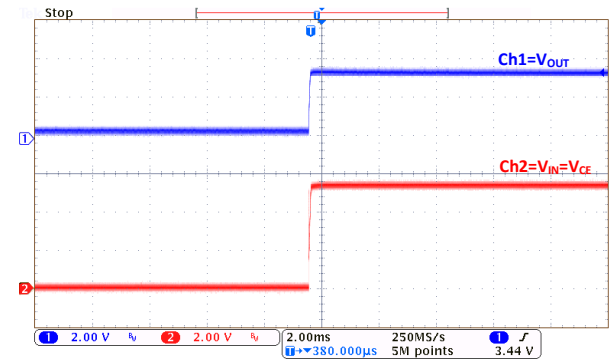

Power-Up:
MD8433($I_{OUT}=0mA$)

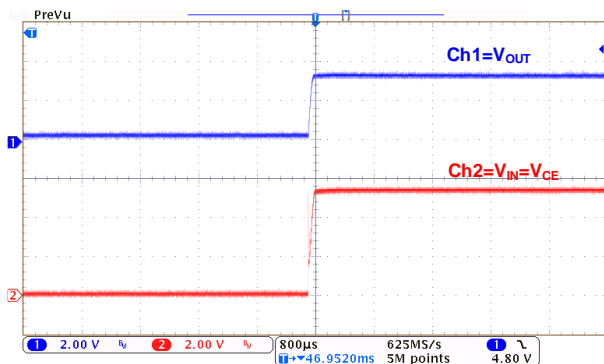

Power-Up:
MD8433($I_{OUT}=300mA$)

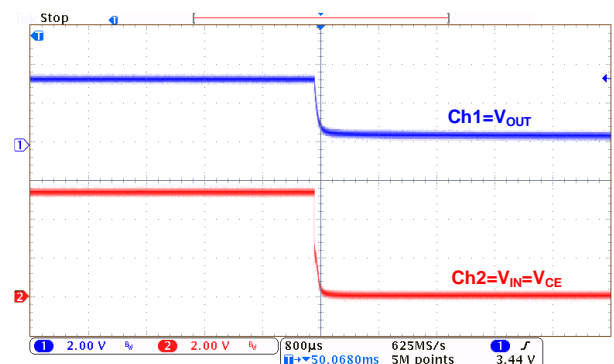

Power-Down:
MD8433($I_{OUT}=0mA$)

■ Typical Performance Characteristics (Continued)

Test Conditions: $V_{IN}=V_{OUT}+2.0V$, $C_{IN}=1.0\mu F$, $C_{OUT}=1.0\mu F$, $T_a=25^\circ C$, unless otherwise indicated.

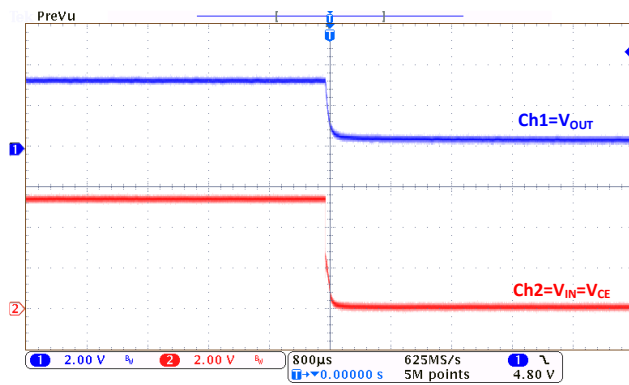

Power-Down:
MD8433($I_{OUT}=300mA$)

■ Operational Explanation

1. Output voltage control

The voltage divided by resistors R1 and R2 is compared with the internal reference voltage by the error amplifier. The amplifier output then drives the P-channel MOSFET connected to the V_{OUT} pin. The output voltage at the V_{OUT} pin is regulated by this negative feedback system. The current limit circuit and short protect circuit operate in relation to output current level. Further, the IC's internal circuitry can be in operation or shutdown modes controlled by the EN pin's signal.

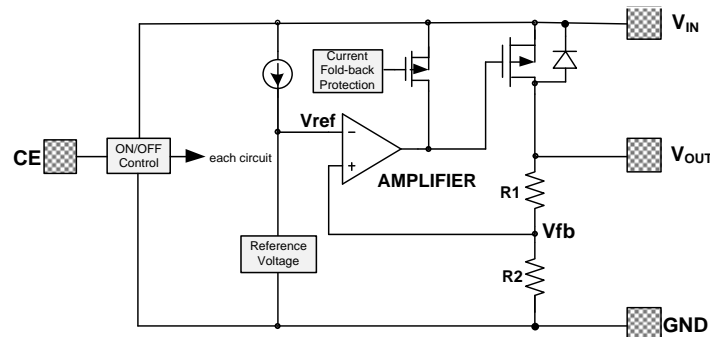

2. Pass transistor

The pass transistor with low turn-on resistance used in MD84XX is a P-channel MOSFET. If the potential on V_{OUT} pin is higher than V_{IN} , it is possible that IC will be destroyed due to reverse current which is caused by parasitic diodes between V_{IN} and V_{OUT} . Therefore, the V_{OUT} pin potential exceeds $V_{IN}+0.3V$ is not allowed.

3. Current foldback and over temperature protection

The MD84XX series includes a combination of a fixed current limiter circuit and a foldback circuit, which aid the operations of the current limiter and circuit protection. When the load current reaches the current limit level, the fixed current limiter circuit operates and output voltage drops. As a result of this drop in output voltage, the foldback circuit operates, output voltage drops further and output current decreases. This design can prevent the chip be damaged due to over temperature, moreover, the heat dissipation is limited by the package type.

Special attention should be paid to that the product of the dropout voltage on the chip and the output current must be smaller than the heat dissipation. If power consumption on the chip is more than the heat dissipation, OTP will protect the chip from damaging due to over temperature.

■ Notes:

1. The input and output capacitors should be placed as close as possible to the IC.
2. If the impedance of the power supply is high, which is caused by forgetting installing input capacitor or installing too small value capacitor, the oscillation may occur.
3. Pay attention to the operation conditions of input and output voltage and load current, such that the power consumption in the IC should not exceed the allowable power consumption of the package even though the chip has short circuit protection.
4. IC has a built-in anti-static protection (ESD) circuit, but please do not add excessive stress to the IC.

■ Packaging Information

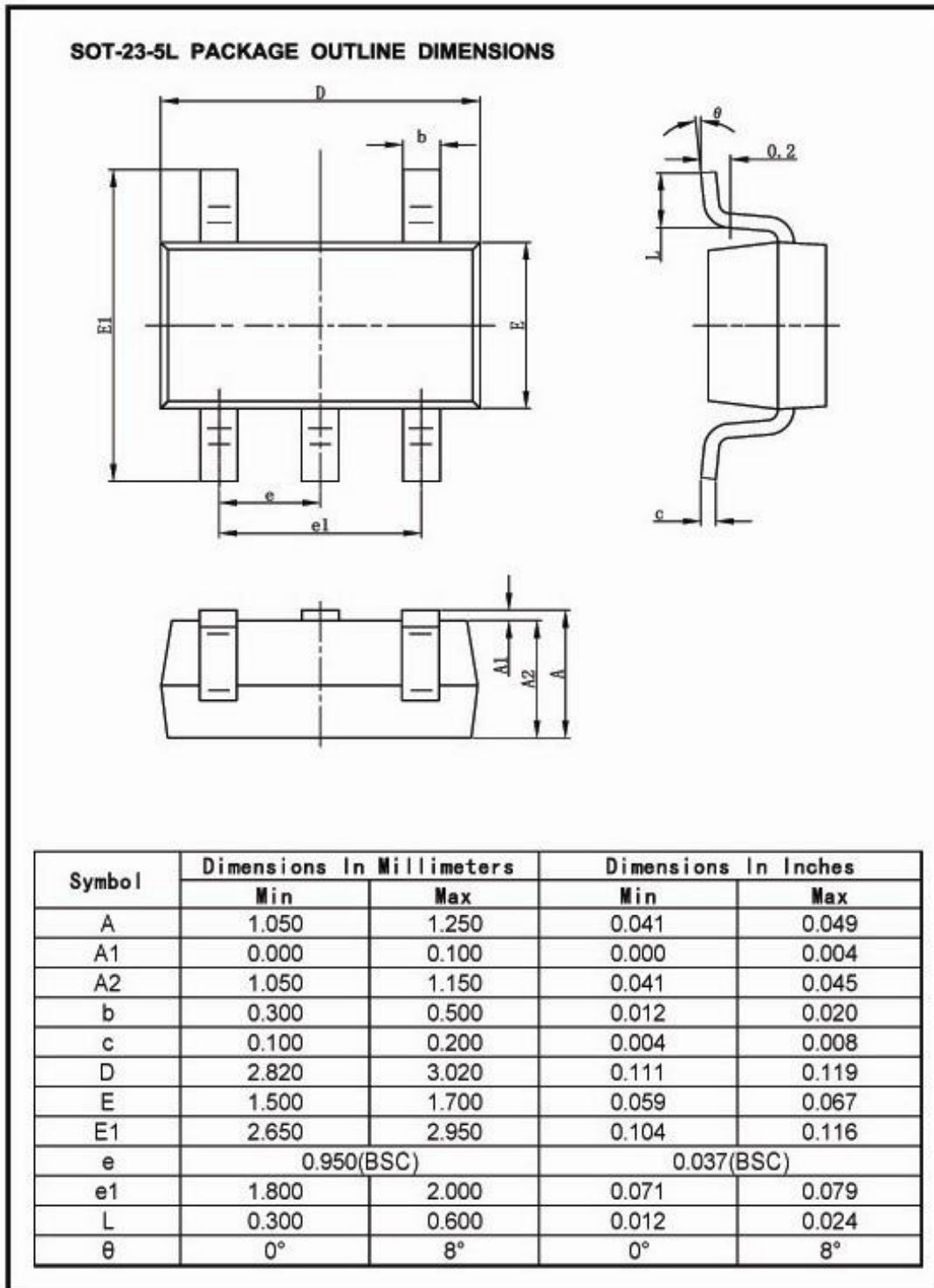

■ Packaging Information (Continued)

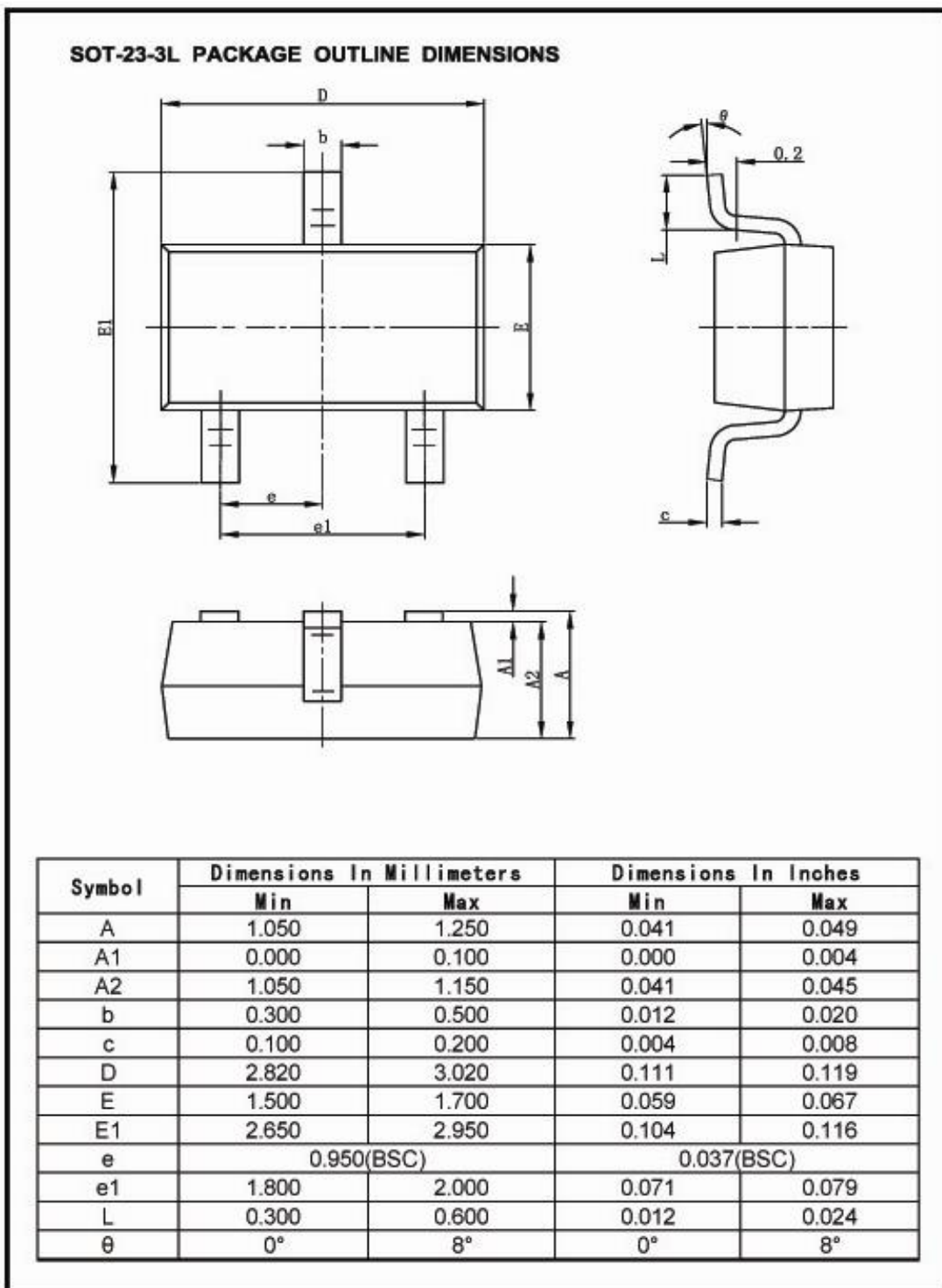

■ Packaging Information (Continued)

DFN(2*2)-6L PACKAGE OUTLINE DIMENSIONS

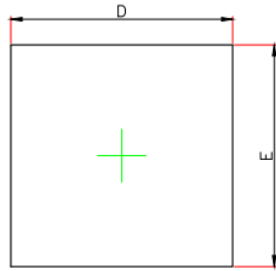

TOP VIEW

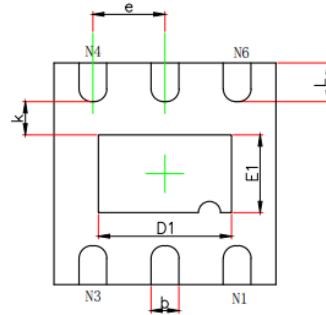

BOTTOM VIEW

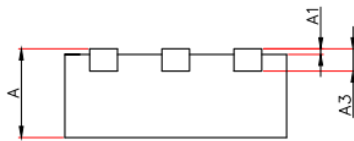

SIDE VIEW

Symbol	Dimensions In Millimeters		Dimensions In Inches	
	Min.	Max.	Min.	Max.
A	0.700/0.800	0.800/0.900	0.028/0.031	0.031/0.035
A1	0.000	0.050	0.000	0.002
A3	0.203REF.		0.008REF.	
D	1.924	2.076	0.076	0.082
E	1.924	2.076	0.075	0.083
D1	1.100	1.300	0.043	0.051
E1	0.600	0.800	0.024	0.031
k	0.200MIN.		0.008MIN.	
b	0.200	0.300	0.007	0.012
e	0.650TYP.		0.026TYP.	
L	0.274	0.426	0.011	0.017

■ Packaging Information (Continued)

DFN(1.6*1.6)-6L PACKAGE OUTLINE DIMENSIONS

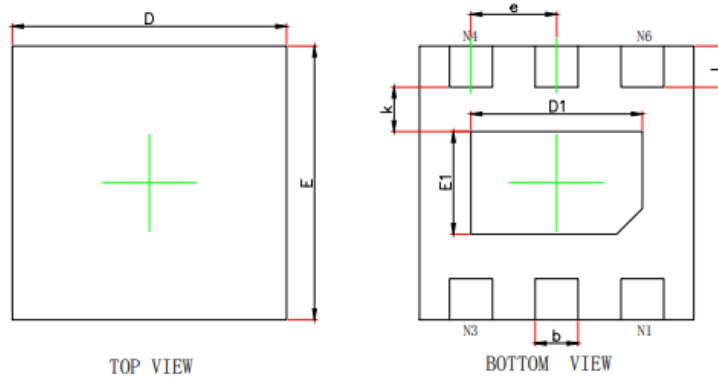

Symbol	Dimensions In Millimeters		Dimensions In Inches	
	Min.	Max.	Min.	Max.
A	0.450/0.550	0.550/0.650	0.018/0.022	0.022/0.026
A1	0.000	0.050	0.000	0.002
A3	0.152REF.		0.006REF.	
D	1.550	1.650	0.061	0.065
E	1.550	1.650	0.061	0.065
E1	0.500	0.700	0.020	0.028
D1	0.900	1.100	0.035	0.043
k	0.200MIN.		0.008REF.	
b	0.200	0.300	0.008	0.012
e	0.500BSC.		0.020BSC.	
L	0.164	0.316	0.006	0.012

■ Packaging Information (Continued)

TO252-4L PACKAGE OUTLINE DIMENSIONS

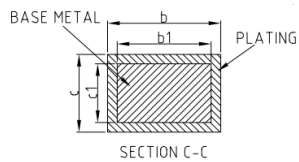
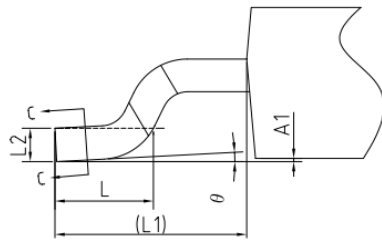
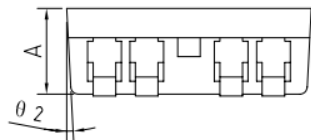
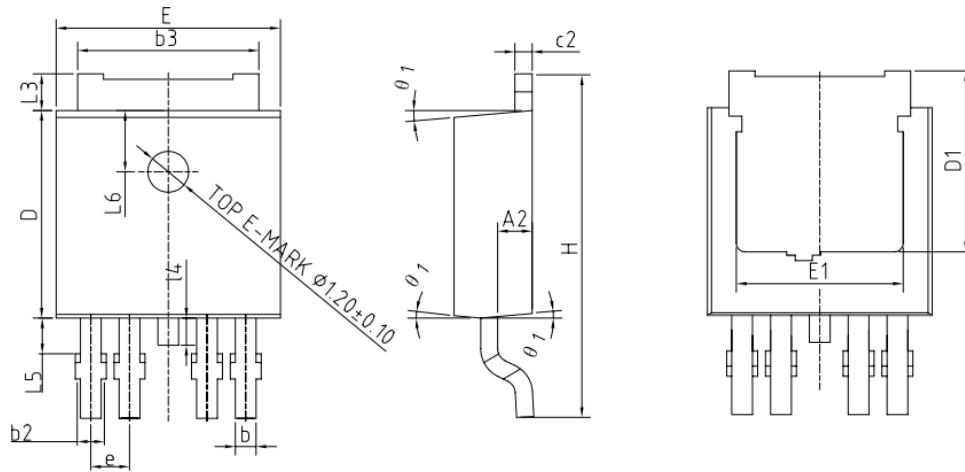

COMMON DIMENSIONS
(UNITS OF MEASURE=MILLIMETER)

SYMBOL	MIN	NOM	MAX
A	2.20	2.30	2.38
A1	0	—	0.10
A2	0.90	1.00	1.10
b	0.57	—	0.70
b1	0.56	0.61	0.66
b2	0.57	—	0.86
b3	5.23	5.33	5.44
c	0.50	—	0.56
c1	0.50	0.51	0.52
c2	0.50	—	0.56
D	6.00	6.10	6.20
D1	5.00	—	—
E	6.50	6.60	6.70
E1	4.70	—	—
e	1.14BSC		
H	9.80	10.10	10.40
L	1.40	1.50	1.70
L1	2.90REF		
L2	0.51BSC		
L3	0.90	—	1.25
L4	0.60	0.80	1.00
L5	0.90	—	1.50
L6	1.80REF		
θ	0°	—	8°
$\theta 1$	3°	5°	7°
$\theta 2$	1°	3°	5°

■ Packaging Information (Continued)

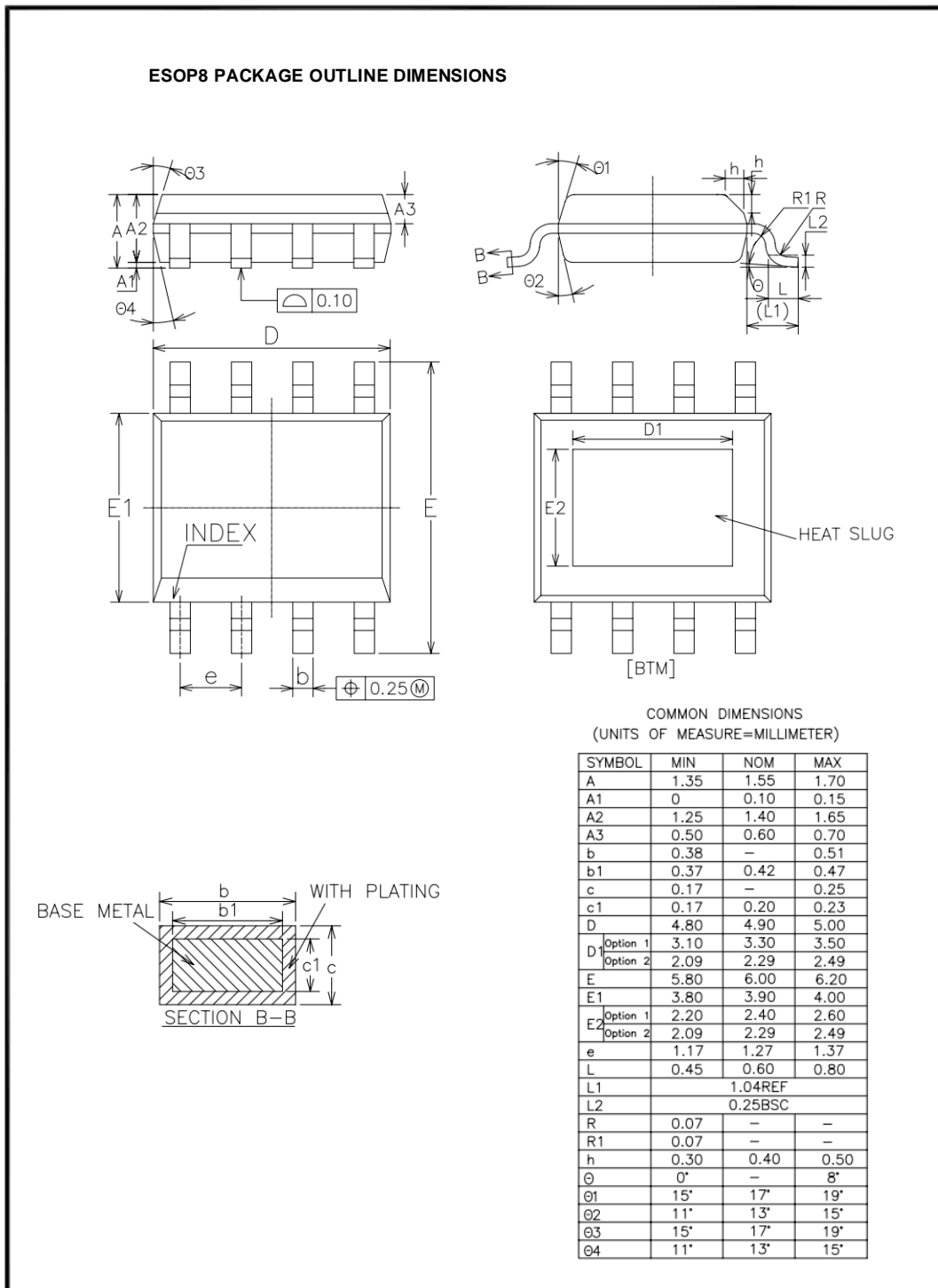

For the newest datasheet, please see the website:

www.md-ic.com.cn

Version V1.8: 20210930

X-ON Electronics

Largest Supplier of Electrical and Electronic Components

Click to view similar products for [Linear Voltage Regulators](#) category:

Click to view products by [Mingda](#) manufacturer:

Other Similar products are found below :

[LV5684PVD-XH](#) [MCDTSA6-2R](#) [L7815ACV-DG](#) [714954EB](#) [ZMR500QFTA](#) [BA033LBSG2-TR](#) [LV5680P-E](#) [L79M05T-E](#) [L78LR05D-MA-E](#) [NCV317MBTG](#) [NTE7227](#) [MP2018GZD-33-P](#) [MP2018GZD-5-P](#) [LV5680NPVC-XH](#) [LT1054CN8](#) [ZTS6538SE](#) [UA78L09CLP](#) [UA78L09CLPR](#) [CAT6221-PPTD-GT3](#) [MC78M09CDTRK](#) [NCV51190MNTAG](#) [78M05](#) [HT7150-1](#) [UM1540DB-18](#) [XC6234H281VR-G](#) [WL2834CA-6/TR](#) [TPL730F33-5TR](#) [TLS850F1TA](#) [V50](#) [TPS549B22RVFR](#) [UM1540DB-33](#) [WL9200P3-50B](#) [WL9100P3-33B](#) [WL9005D4-33](#) [XC6219B152MR](#) [WL2855K33-3/TR](#) [PJ54BM33SE](#) [PJ9500M25SA](#) [MD7218E33PC1](#) [H7533-2PR](#) [SK7812AU](#) [SD1A30](#) [78L33](#) [TP78L33T3](#) [L78L33ACUTR](#) [SK6513ST3A-50](#) [SK6054D4-09](#) [SK6054D4-18](#) [SK6054D4-11](#) [SK6054D4-10](#) [LM79L12F](#)