



MD85XX is a high voltage (up to 40V) ultra-low quiescent current low dropout voltage regulator (LDO) manufactured in CMOS processes. It can deliver up to 300mA of current while consuming only 1.5uA of quiescent current. It consists of a reference voltage generator, an error amplifier, a current foldback circuit, and a phase compensation circuit plus a driver transistor. The MD85XX is designed specifically for applications where very-low  $I_Q$  is a critical parameter. This device

maintains low quiescent current consumption even in dropout mode to further increase the battery life. When in shutdown or disabled mode, the device consumes less than 100-nA  $I_Q$  even with input voltage of 40V that helps increase the shelf life of the battery.

### ■ Features

- Ultra-low Quiescent Current: 1.5uA
- Maximum Input Voltage: 40V
- Output Voltage Highly Accurate:  $\pm 2\%$
- Maximum Output Current: 300mA
- Dropout Voltage: 4mV@ $I_{OUT}=1mA$
- Temperature Stability:  $\pm 50ppm/^{\circ}C$
- ON/OFF Logic = Enable High
- Protections Circuits: Current Limiter, Short Circuit, Foldback, Thermal shutdown
- Output Capacitor: Low ESR Ceramic Capacitor Compatible

### ■ Applications

- Smart wearer
- Long-life battery-powered devices
- Portable mobile devices, such as mobile phones, cameras, and so on
- Wireless communication equipment

### ■ Typical Applications

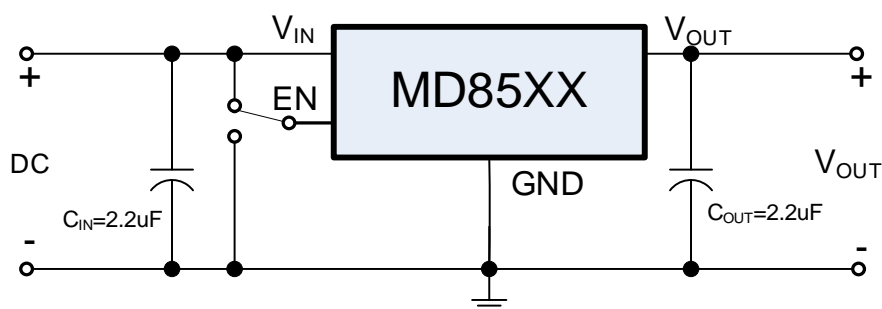

## Pin Configuration and Functions

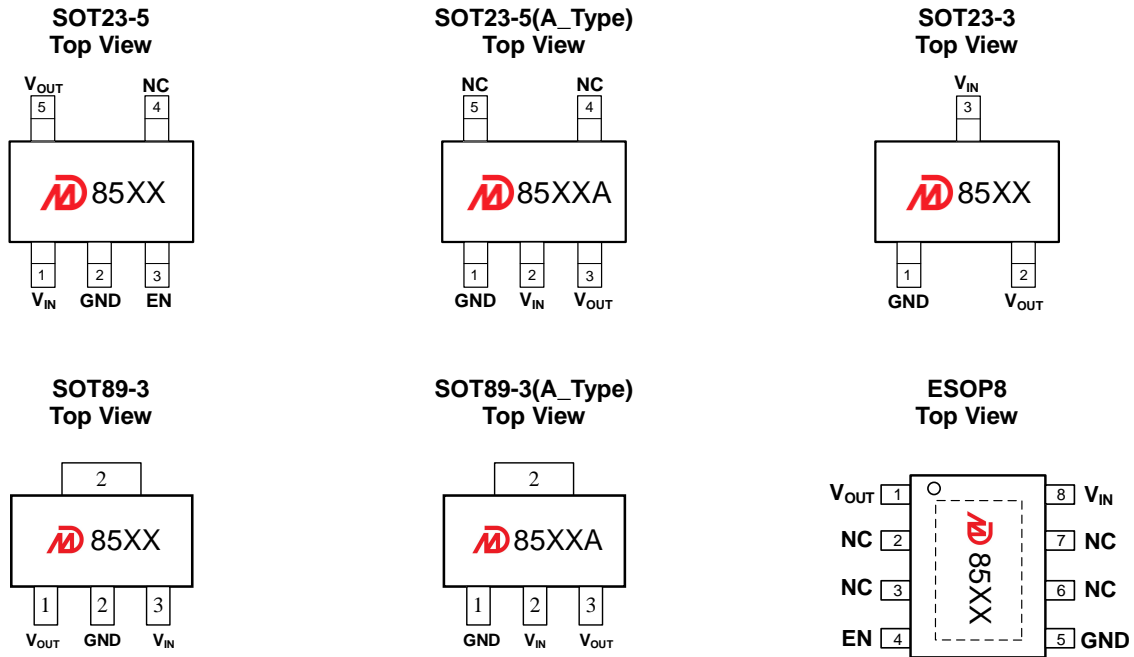



















### Pin Functions

NAME	DESCRIPTION
V <sub>IN</sub>	Power Input Pin.
EN	Enable pin. Drive this pin high to enable the device. Drive this pin low to put the device into low current shutdown.
V <sub>OUT</sub>	Regulated output voltage pin
GND	Ground
Thermal pad	The thermal pad is electrically connected to the GND node. Connect this pad to the GND plane for improved thermal performance.
NC	No internal connection

## Product Selections

Product Name	V <sub>OUT</sub> (V)	Package	Ordering Name	Marking	Package Information
MD8530	3.0	SOT23-5L	MD85E30QC3	8530	Tape and Reel, 3000pcs
MD8533	3.3	SOT23-5L	MD85E33QC3	8533	
MD8536	3.6	SOT23-5L	MD85E36QC3	8536	
MD8550	5.0	SOT23-5L	MD85E50QC3	8550	
MD8530A	3.0	SOT23-5L	MD85A30QC3	8530A	
MD8533A	3.3	SOT23-5L	MD85A33QC3	8533A	
MD8536A	3.6	SOT23-5L	MD85A36QC3	8536A	
MD8550A	5.0	SOT23-5L	MD85A50QC3	8550A	
MD8530	3.0	SOT23-3L	MD85E30QA3	8530	Tape and Reel, 3000pcs
MD8533	3.3	SOT23-3L	MD85E33QA3	8533	
MD8536	3.6	SOT23-3L	MD85E36QA3	8536	
MD8550	5.0	SOT23-3L	MD85E50QA3	8550	

MD8530	3.0	SOT89-3L	MD85E30PA1	 8530	Tape and Reel, 1000pcs
MD8533	3.3	SOT89-3L	MD85E33PA1	 8533	
MD8536	3.6	SOT89-3L	MD85E36PA1	 8536	
MD8550	5.0	SOT89-3L	MD85E50PA1	 8550	
MD8553	5.3	SOT89-3L	MD85E53PA1	 8553	
MD8557	5.7	SOT89-3L	MD85E57PA1	 8557	
MD85C0	12.0	SOT89-3L	MD85EC0PA1	 85C0	
MD85F0	15.0	SOT89-3L	MD85EF0PA1	 85F0	
MD8530A	3.0	SOT89-3L	MD85A30PA1	 8530A	Tape and Reel, 1000pcs
MD8533A	3.3	SOT89-3L	MD85A33PA1	 8533A	
MD8536A	3.6	SOT89-3L	MD85A36PA1	 8536A	
MD8550A	5.0	SOT89-3L	MD85A50PA1	 8550A	
MD85C0A	12.0	SOT89-3L	MD85AC0PA1	 85C0A	
MD85F0A	15.0	SOT89-3L	MD85EF0PA1	 85F0A	
MD8533	3.3	ESOP8	MD85E33SF4	 8533	Tape and Reel, 4000pcs
MD8550	5.0	ESOP8	MD85E50SF4	 8550	
MD85C0	12.0	ESOP8	MD85EC0SF4	 85C0	
MD85F0	15.0	ESOP8	MD85EF0SF4	 85F0	

**Notes:**

1\* Customer can request to customize the output voltage ranged from 1.2V to 15V if desired voltage is not found in the selections.

2\* Customer can request customization of package choice.

3\* Please pay attention to the MARKING of the product package type.

**■ Absolute Maximum Ratings (Unless otherwise indicated: T<sub>a</sub>=25°C)**

PARAMETER	SYMBOL	RATINGS		UNITS
Input Voltage	V <sub>IN</sub>	-0.3 ~ 45		V
Output Voltage	V <sub>OUT</sub>	V <sub>SS</sub> -0.3 ~ V <sub>IN</sub> +0.3V		
Power Dissipation	P <sub>D</sub>	SOT23-5	250	mW
		SOT23-3	250	
		ESOP8	1800	
		SOT89-3	1000	
Thermal Resistance	R <sub>θJB</sub> <sup>(1)</sup>	SOT23-5	180	°C/W
		SOT23-3	200	
		ESOP8	80	
		SOT89-3	100	
Operating Ambient Temperature	T <sub>opr</sub>	-40 ~ +85		°C
Storage Temperature	T <sub>stg</sub>	-40 ~ +125		
ESD Protection	ESD HBM	5000		V

**Note:** Stresses above those listed under “Absolute Maximum Ratings” may cause permanent damage to the device.

<sup>(1)</sup> Mounted on JEDEC standard 4layer (2s2p) PCB test board

**■ Notes on Use**

Input Capacitor (C<sub>IN</sub>): 2.2μF above

Output Capacitor (C<sub>OUT</sub>): 2.2μF above

## ■ Electrical Characteristics

MD85XX Series (Unless otherwise indicated:  $T_a=25^\circ\text{C}$ )

PARAMETER	SYMBOL	CONDITIONS	MIN.	TYP.	MAX.	UNIT	
Output Voltage <sup>*1</sup>	$V_{OUT(S)}$	$V_{IN} = V_{OUT(S)} + 2V, I_{OUT} = 1\text{mA}$	$V_{OUT(S)} \times 0.98$	$V_{OUT(S)}$	$V_{OUT(S)} \times 1.02$	V	
Dropout Voltage <sup>*2</sup>	$V_{DROP}$	$V_{EN} = V_{IN}, V_{OUT(S)} = 3.3V$ $I_{OUT} = 1\text{mA}$		4	8	mV	
		$V_{EN} = V_{IN}, V_{OUT(S)} = 3.3V$ $I_{OUT} = 300\text{mA}$		1200	1800		
Line Regulation	$\frac{\Delta V_{OUT}}{\Delta V_{IN} \cdot V_{OUT(S)}}$	$V_{OUT(S)} + 2V \leq V_{IN} \leq 40V$ $I_{OUT} = 1\text{mA}$		0.01	0.02	%/V	
Load Regulation	$\Delta V_{OUT2}$	$V_{IN} = V_{OUT(S)} + 2V$ $1\text{mA} \leq I_{OUT} \leq 300\text{mA}$	$V_{OUT(S)} \leq 5.3V$	20	40	mV	
			$V_{OUT(S)} > 5.3V$	50	80		
Temperature Stability	$\frac{\Delta V_{OUT}}{\Delta T_a \cdot V_{OUT(S)}}$	$V_{IN} = V_{OUT(S)} + 2V, I_{OUT} = 10\text{mA}$ $-40^\circ\text{C} \leq T_a \leq 125^\circ\text{C}$		$\pm 50$		ppm/ $^\circ\text{C}$	
GND Current ( $V_{EN} = V_{IN}$ )	$I_{GND}$	no load	$V_{OUT(S)} < 3.0V$	0.8	1.2	2	uA
			$3.0 \leq V_{OUT(S)} \leq 5.3V$	1	1.5	2.5	
			$V_{OUT(S)} > 5.3V$	1.5	2.3	3.5	
		$I_{OUT} = 100\text{mA}$		420			
Shutdown Current ( $EN = 0$ )	$I_{SHUT}$	$V_{IN} = 40.0V, V_{EN} = 0$		0.1	1		
Input Voltage	$V_{IN}$	---	2.2		40	V	
Maximum Output Current	$I_{OUTMAX}$		300	350			
Current Limit <sup>*3</sup>	$I_{LIM}$	$V_{IN} = V_{OUT(S)} + 2V,$ $V_{OUT} = 0.95 \times V_{OUT(S)}$	350	550		mA	
Short Circuit Current	$I_{SHORT}$	$V_{IN} = V_{EN} = V_{OUT(S)} + 2.0V$ $V_{OUT} = 0V$		65			
Power Supply Rejection Ratio	PSRR	$f = 100\text{Hz}, I_{OUT} = 10\text{mA}$		79		dB	
		$f = 1\text{kHz}, I_{OUT} = 10\text{mA}$		62			
		$f = 10\text{kHz}, I_{OUT} = 10\text{mA}$		48			
		$f = 100\text{kHz}, I_{OUT} = 10\text{mA}$		40			
EN 'H' Level Voltage	$V_{ENH}$		1.5		40.0	V	
EN 'L' Level Voltage	$V_{ENL}$		0		0.6		
EN 'H' Level Current	$I_{ENH}$	$V_{IN} = 40V, V_{EN} = V_{IN}$	-0.1		0.1	uA	
EN 'L' Level Voltage	$I_{ENL}$	$V_{IN} = 40V, V_{EN} = 0$	-0.1		0.1		
Over Temperature Protection	OTP	$I_{OUT} = 1\text{mA}$		170		$^\circ\text{C}$	

Notes:

- $V_{OUT(S)}$ : Output voltage when  $V_{IN} = V_{OUT} + 2V, I_{OUT} = 1\text{mA}$ .
- $V_{DROP} = V_{IN1} - (V_{OUT(S)} \times 0.98)$  where  $V_{IN1}$  is the input voltage when  $V_{OUT} = V_{OUT(S)} \times 0.98$ .
- $I_{LIM}$ : Output current when  $V_{IN} = V_{OUT(S)} + 2V$  and  $V_{OUT} = 0.95 \times V_{OUT(S)}$ .

■ Typical Performance Characteristics

Test Conditions:  $V_{IN}=V_{OUT}+2.0V$ ,  $C_{IN}=2.2\mu F$ ,  $C_{OUT}=2.2\mu F$ ,  $T_a=25^\circ C$ , unless otherwise indicated.

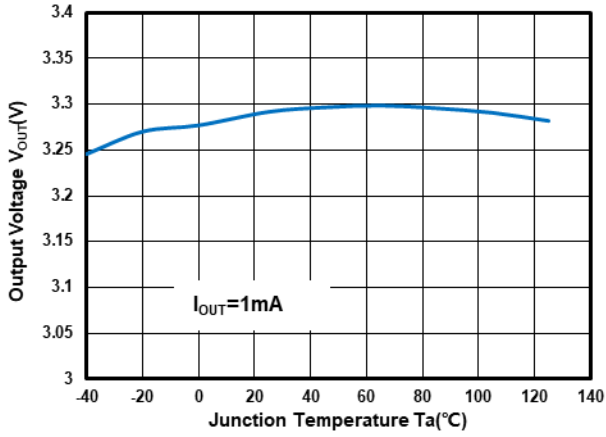

Output Voltage vs Temperature at  $V_{OUT}=3.3V$

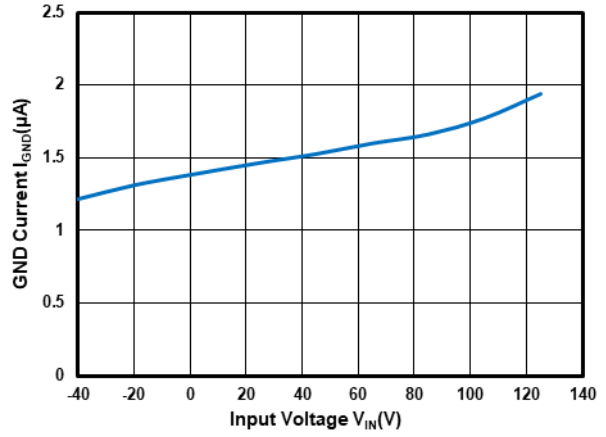

GND Current vs Temperature at  $V_{OUT}=3.3V$

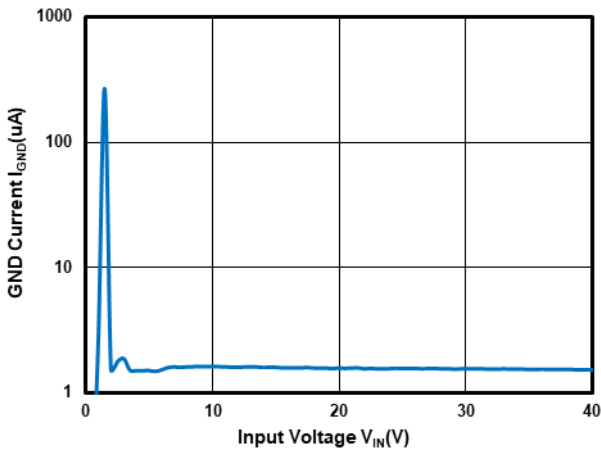

GND Current vs Input Voltage at  $V_{OUT}=3.3V$

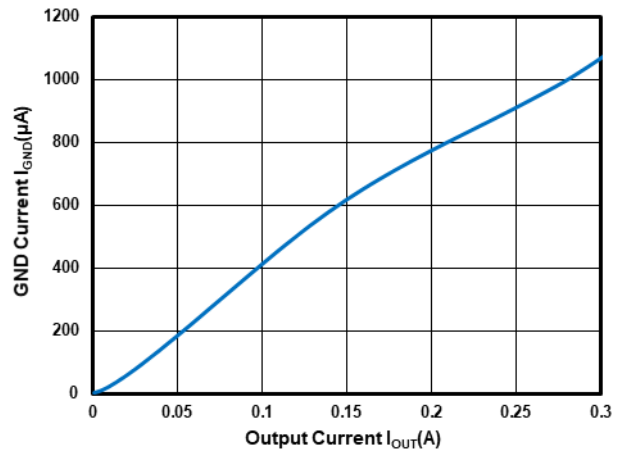

GND Current vs Output Current at  $V_{OUT}=3.3V$

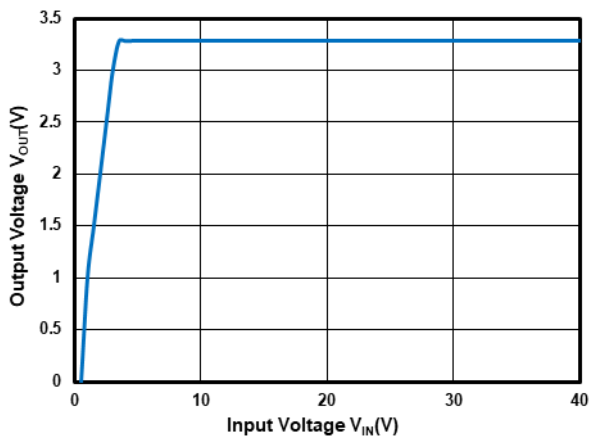

Output Voltage vs Input Voltage at  $V_{OUT}=3.3V$

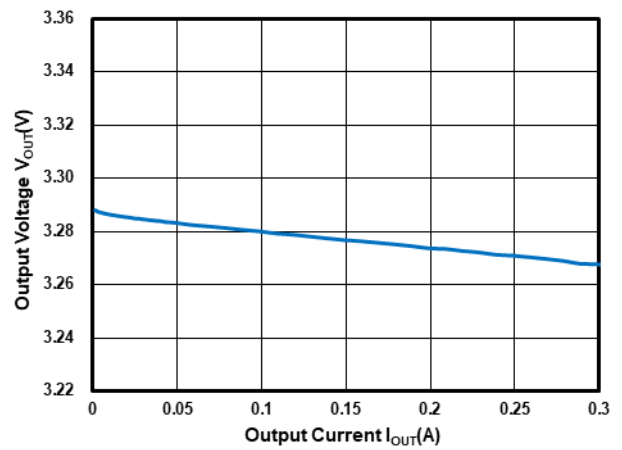

Output Voltage vs Output Current at  $V_{OUT}=3.3V$

■ Typical Performance Characteristics (Continued)

Test Conditions:  $V_{IN}=V_{OUT}+2.0V$ ,  $C_{IN}=2.2\mu F$ ,  $C_{OUT}=2.2\mu F$ , unless otherwise indicated.

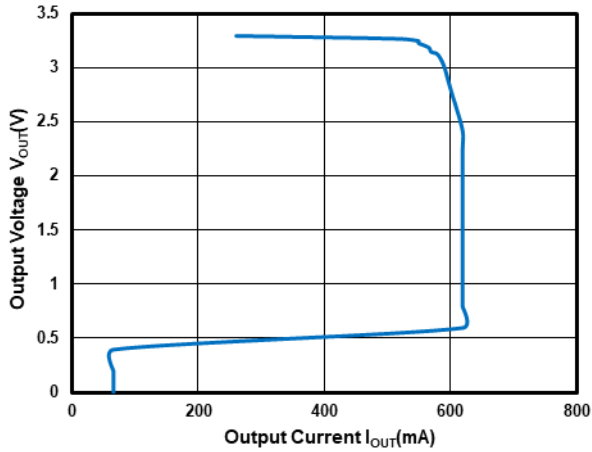

Output Current Fold-back at  $V_{OUT}=3.3V$

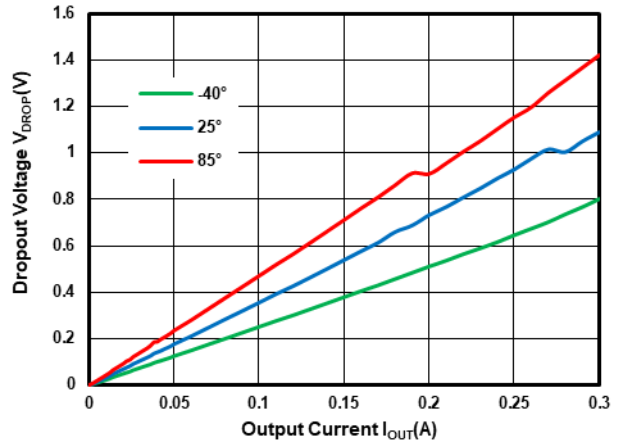

Dropout Voltage vs Temperature at  $V_{OUT}=3.3V$

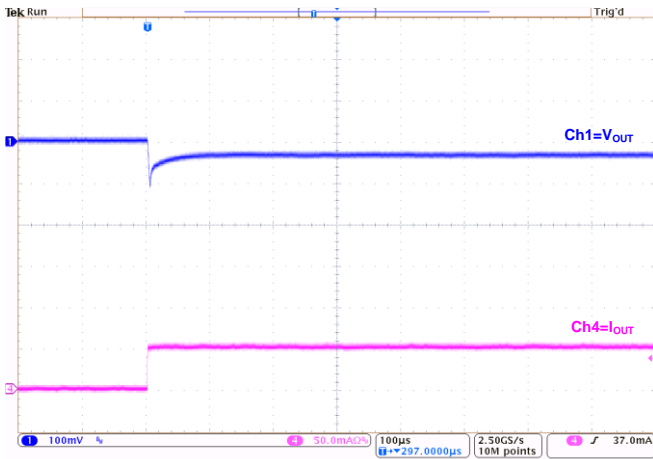

Load Transient at  $V_{OUT}=3.3V$ :  
( $I_{OUT}=0mA\sim 50mA$ )

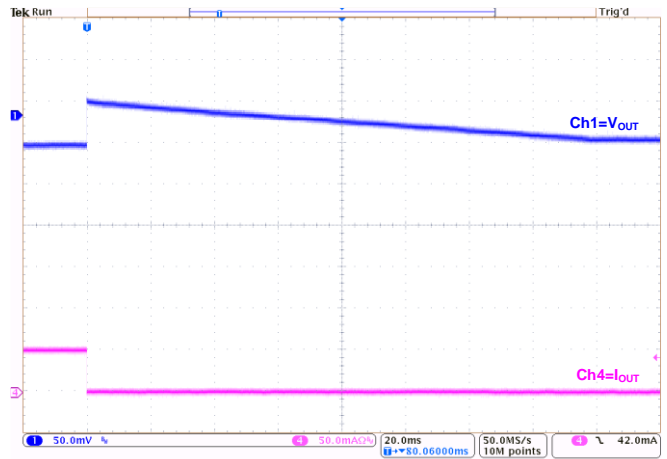

Load Transient at  $V_{OUT}=3.3V$ :  
( $I_{OUT}=50mA\sim 0mA$ )

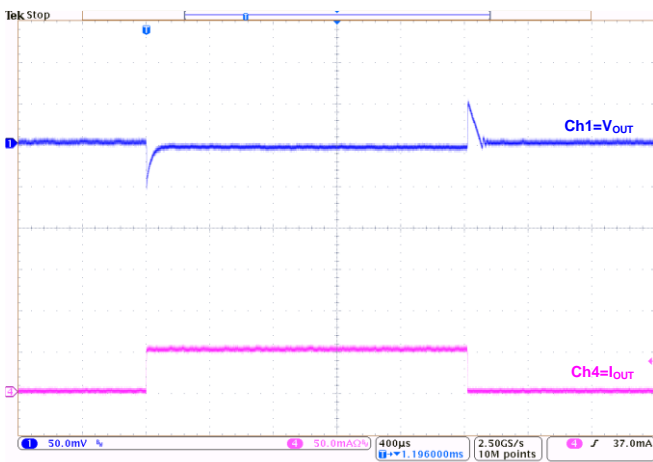

Load Transient at  $V_{OUT}=3.3V$ :  
( $I_{OUT}=1mA\sim 50mA\sim 1mA$ )

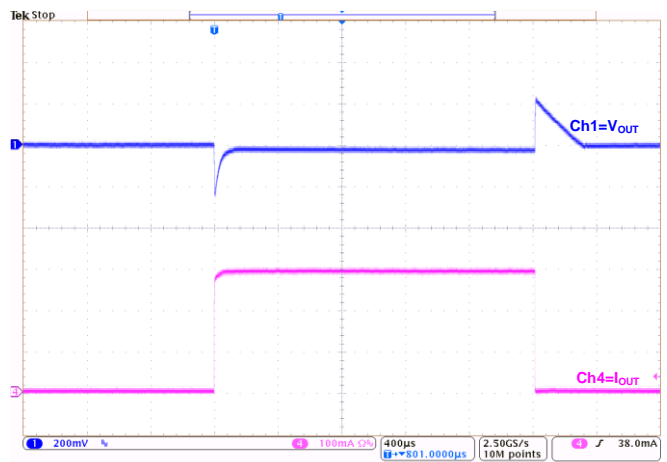

Load Transient at  $V_{OUT}=3.3V$ :  
( $I_{OUT}=1mA\sim 300mA\sim 1mA$ )

■ Typical Performance Characteristics (Continued)

Test Conditions:  $V_{IN}=V_{OUT}+2.0V$ ,  $C_{IN}=2.2\mu F$ ,  $C_{OUT}=2.2\mu F$ ,  $T_a=25^\circ C$ , unless otherwise indicated.

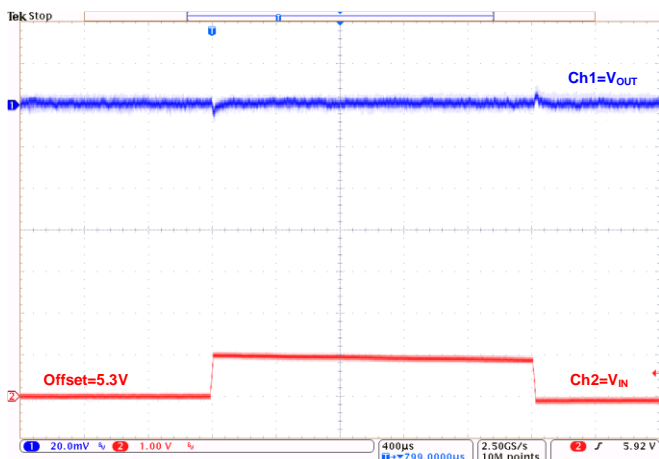

Line Transient at  $V_{OUT}=3.3V$ :  
( $I_{OUT}=1mA$ )

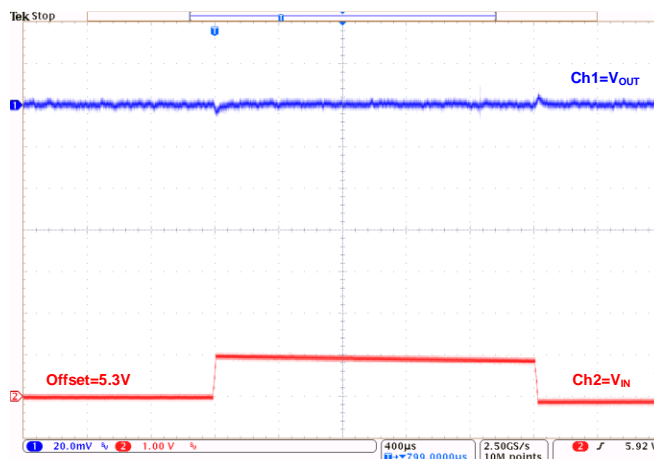

Line Transient at  $V_{OUT}=3.3V$ :  
( $I_{OUT}=10mA$ )

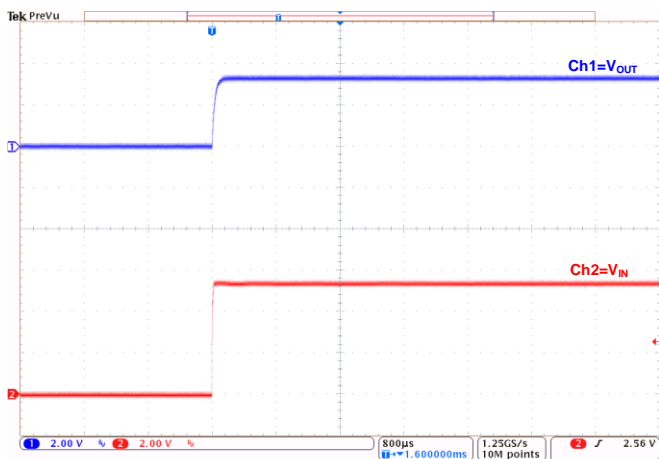

Power-Up at  $V_{OUT}=3.3V$ :  
( $I_{OUT}=1mA$ )

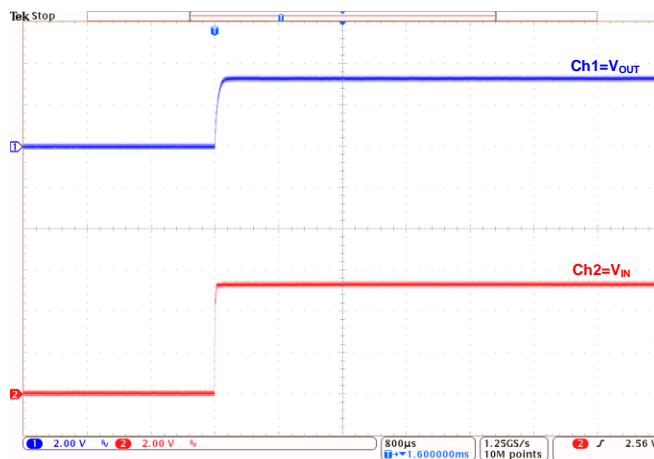

Power-Up at  $V_{OUT}=3.3V$ :  
( $I_{OUT}=300mA$ )

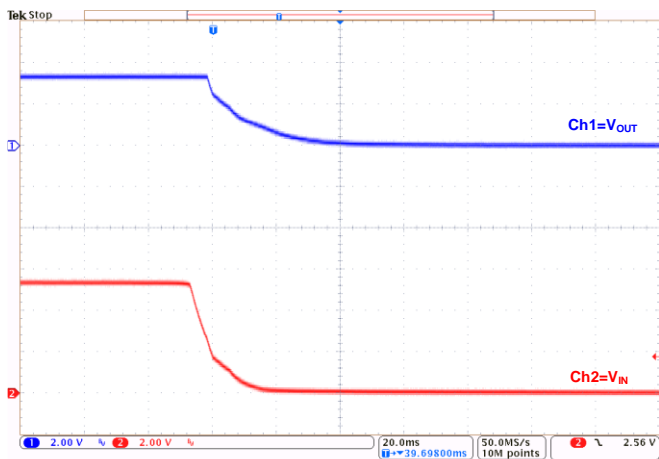

Power-Down at  $V_{OUT}=3.3V$ :  
( $I_{OUT}=1mA$ )

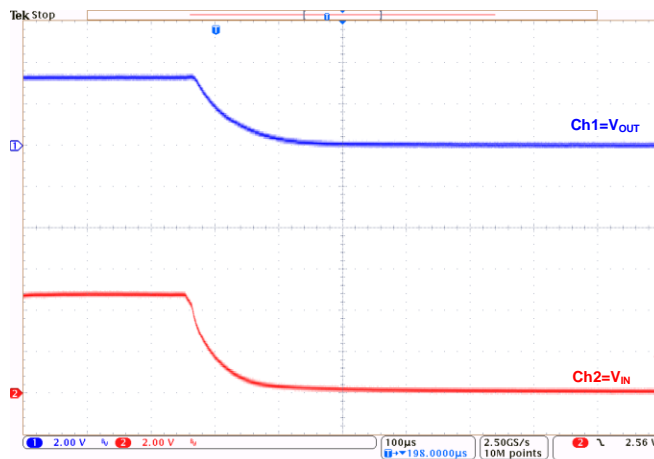

Power-Down at  $V_{OUT}=3.3V$ :  
( $I_{OUT}=300mA$ )

### ■ Typical Performance Characteristics (Continued)

Test Conditions:  $V_{IN}=V_{OUT}+2.0V$ ,  $C_{IN}=2.2\mu F$ ,  $C_{OUT}=2.2\mu F$ ,  $T_a=25^\circ C$ , unless otherwise indicated.

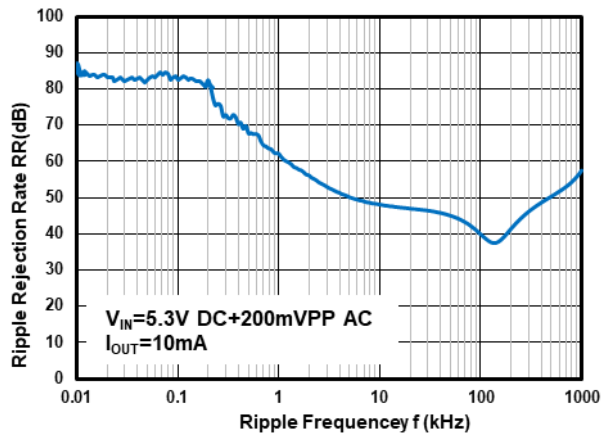

Power Supply Rejection Ratio at  $V_{OUT}=3.3V$



## ■ Operational Explanation

### 1. Output voltage control

The voltage divided by resistors R1 and R2 is compared with the internal reference voltage by the error amplifier. The amplifier output then drives the P-channel MOSFET connected to the  $V_{OUT}$  pin. The output voltage at the  $V_{OUT}$  pin is regulated by this negative feedback system. The current limit circuit and short protect circuit operate in relation to output current level. Further, the IC's internal circuitry can be in operation or shutdown modes controlled by the CE pin's signal.

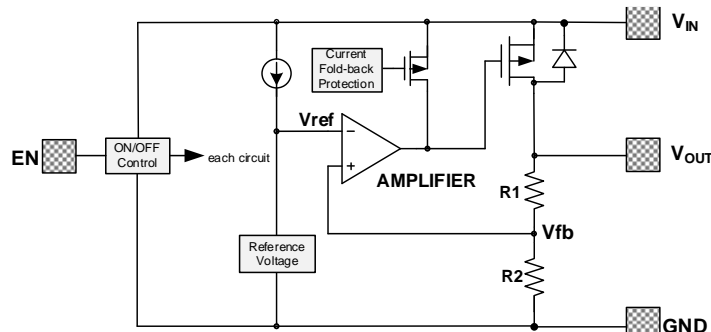

### 2. Pass transistor

The pass transistor with low turn-on resistance used in MD85XX is a P-channel MOSFET. If the potential on  $V_{OUT}$  pin is higher than  $V_{IN}$ , it is possible that IC will be destroyed due to reverse current which is caused by parasitic diodes between  $V_{IN}$  and  $V_{OUT}$ . Therefore, the  $V_{OUT}$  pin potential exceeds  $V_{IN}+0.3V$  is not allowed.

### 3. Current foldback, short circuit protection and over temperature protection

The MD85XX series includes a combination of a fixed current limiter circuit and a foldback circuit, which aid the operations of the current limiter and circuit protection. When the load current reaches the current limit level, the fixed current limiter circuit operates and output voltage drops. As a result of this drop in output voltage, the foldback circuit operates, output voltage drops further and output current decreases. The short circuit current is about 65mA (typical value). This design can prevent the chip be damaged due to over temperature, moreover, the heat dissipation is limited by the package type.

Special attention should be paid to that the product of the dropout voltage on the chip and the output current must be smaller than the heat dissipation. If power consumption on the chip is more than the heat dissipation, OTP will protect the chip from damaging due to over temperature.

## ■ Notes:

1. The input and output capacitors should be placed as close as possible to the IC.
2. If the impedance of the power supply is high, which is caused by forgetting installing input capacitor or installing too small value capacitor, the oscillation may occur.
3. Pay attention to the operation conditions of input and output voltage and load current, such that the power consumption in the IC should not exceed the allowable power consumption of the package even though the chip has short circuit protection.
4. IC has a built-in anti-static protection (ESD) circuit, but please do not add excessive stress to the IC.

■ Packaging Information

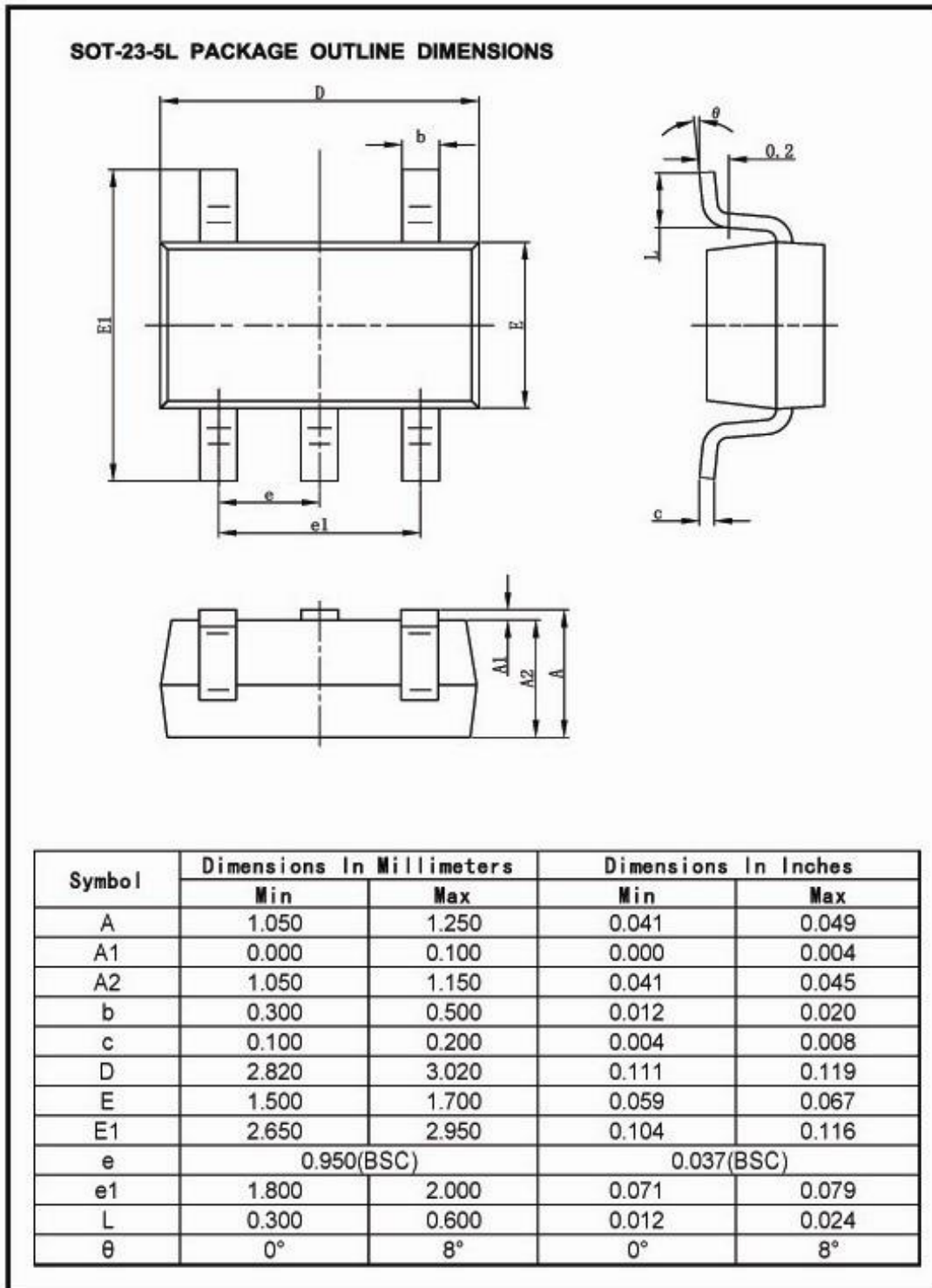

■ Packaging Information (Continued)

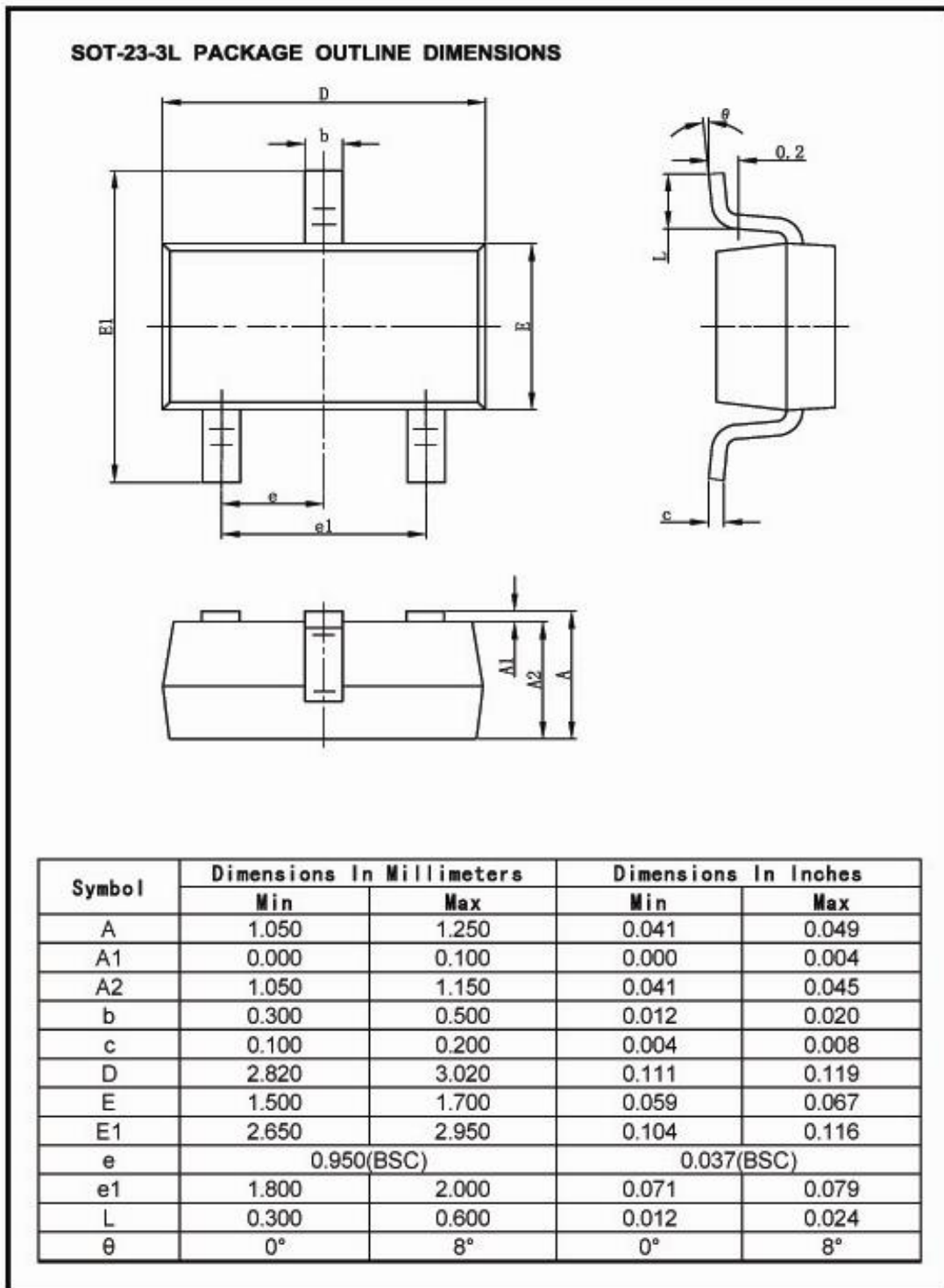

■ Packaging Information (Continued)

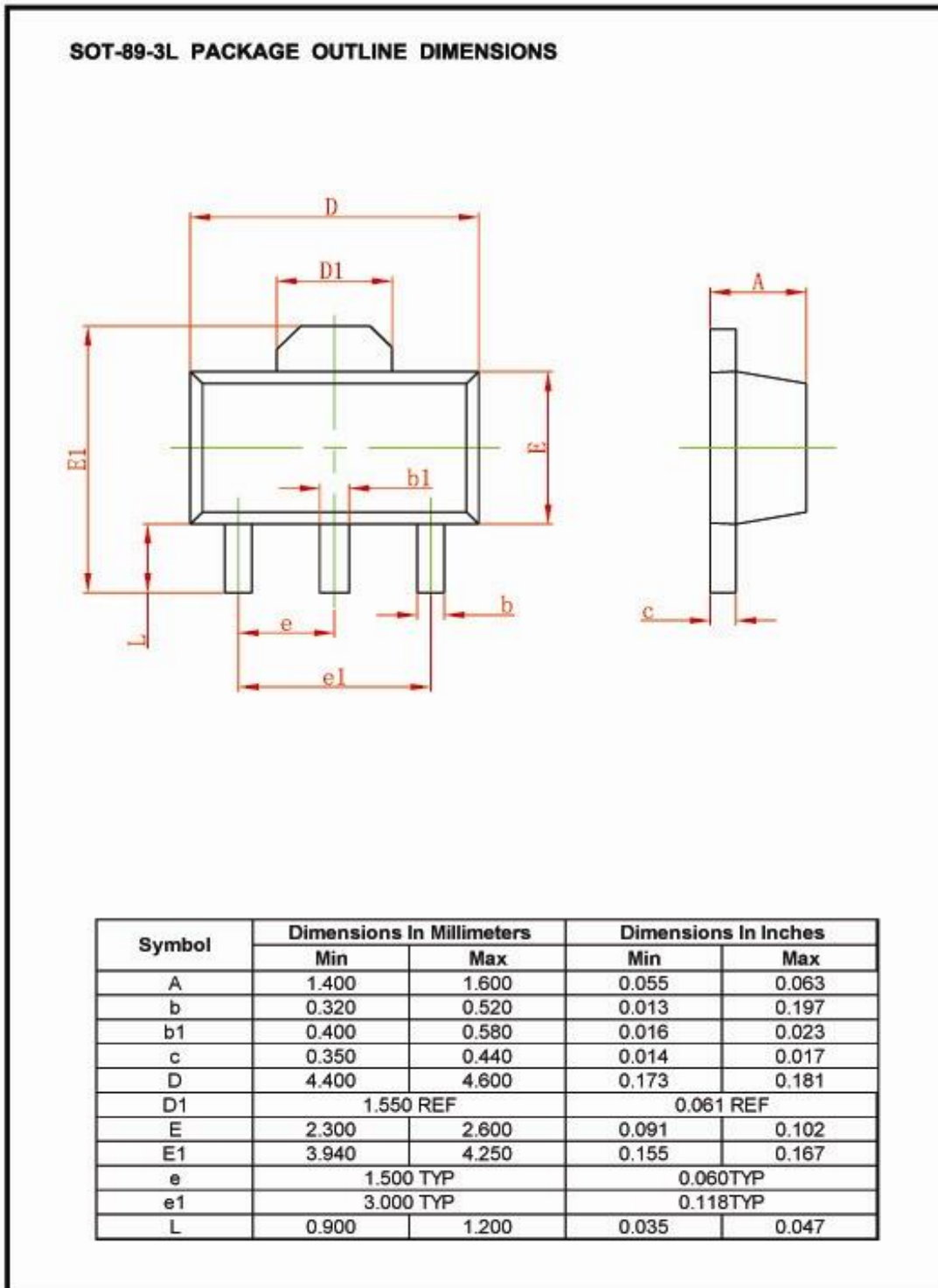

■ Packaging Information (Continued)

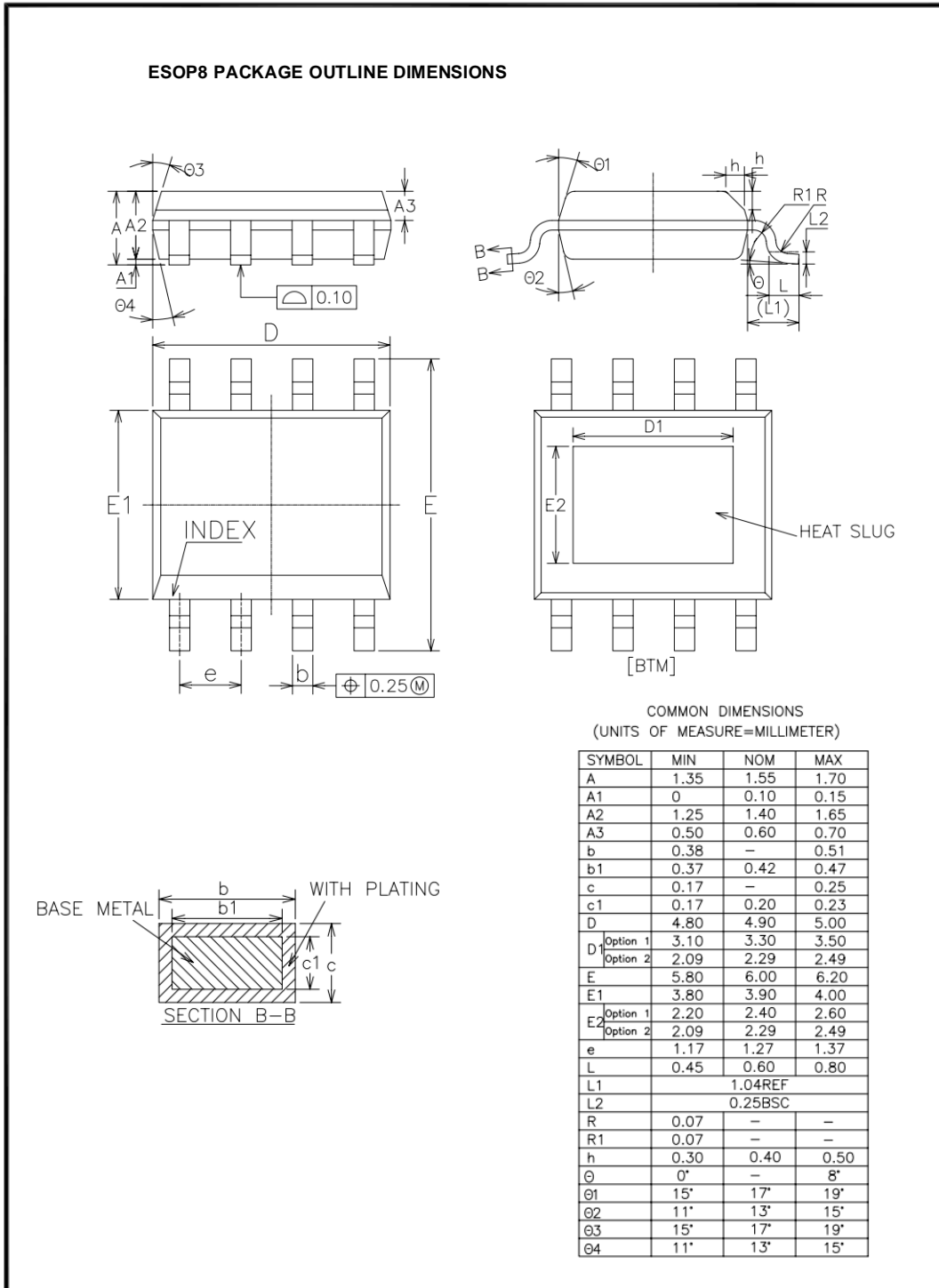

For the newest datasheet, please see the website:

[www.md-ic.com.cn](http://www.md-ic.com.cn)

Version V1.0: 20200915

## X-ON Electronics

Largest Supplier of Electrical and Electronic Components

*Click to view similar products for [Linear Voltage Regulators](#) category:*

*Click to view products by [Mingda](#) manufacturer:*

Other Similar products are found below :

[LV56831P-E](#) [LV5684PVD-XH](#) [MCDTSA6-2R](#) [L7815ACV-DG](#) [PQ3DZ53U](#) [LV56801P-E](#) [TLE42794G](#) [L78L05CZ/1SX](#) [L78LR05DL-MA-E](#) [636416C](#) [714954EB](#) [BA033LBSG2-TR](#) [LV5680P-E](#) [L78M15CV-DG](#) [TLS202B1MBV33HTSA1](#) [L79M05T-E](#) [TLS202A1MBVHTSA1](#) [L78LR05D-MA-E](#) [NCV317MBTG](#) [NTE7227](#) [LV5680NPVC-XH](#) [LT1054CN8](#) [MP2018GZD-5-Z](#) [MP2018GZD-33-Z](#) [MIC5281-3.3YMM](#) [RT9078-28GQZ](#) [MC78L06BP-AP](#) [TA48LS05F\(TE85L,F\)](#) [TA78L12F\(TE12L,F\)](#) [TC47BR5003ECT](#) [TCR2LN12,LF\(S](#) [TCR2LN28,LF\(S](#) [TCR2LN30,LF\(S](#) [TCR3DF295,LM\(CT](#) [TCR3DF40,LM\(CT](#) [BA178M20CP-E2](#) [L78M12ABDT](#) [LM7812SX/NOPB](#) [LR645N3-G-P003](#) [LR645N3-G-P013](#) [ZXTR2005P5-13](#) [SCD7812BTG](#) [TCR3DF335,LM\(CT](#) [ZXTR2012K-13](#) [TLE42994E V33](#) [ZXTR2008K-13](#) [ZXTR2005K-13](#) [LA5693D-E](#) [L88R05DL-E](#) [ADP3300ARTZ-2.7RL7](#)