

# Ceramic Bandpass Filter

## BFCG-252+

50Ω      2400 to 2500 MHz

### The Big Deal

- Rugged, ceramic construction
- Tiny size, 0.079" x 0.049" x 0.037" (0805)
- Good power handling



CASE STYLE: GE0805C-3

### Product Overview

Mini-Circuits' BFCG-252+ is a LTCC band pass filter with a passband from 2400 to 2500 MHz, supporting a variety of applications. This model provides 1.7 dB typical passband insertion loss and provides a very good stopband rejection due to strategically constructed layout with minimal interaction between components. It provides a wide operating temperature range from -55 to +125°C. Housed in a tiny 0805 ceramic form factor with wrap-around terminations, the filter is ideal for dense PCB layouts and with minimal performance variation due to parasitics.

### Key Features

Feature	Advantages
Ultra-wide stopband	The LTCC band pass filter provides a very good stopband rejection suitable for high end applications.
LTCC Construction	Provides repeatable performance in a rugged, ceramic package well suited for tough environments such as high humidity and temperature extremes.
Tiny size (0.079 x 0.049 x 0.037")	Saves space in dense circuit board layouts and minimizes the effects of parasitics.
Good power handling	Supports a wide range of system power requirements.
Wrap-around terminations	Provides excellent solderability and easy visual inspection

#### Notes

- A. Performance and quality attributes and conditions not expressly stated in this specification document are intended to be excluded and do not form a part of this specification document.  
B. Electrical specifications and performance data contained in this specification document are based on Mini-Circuit's applicable established test performance criteria and measurement instructions.  
C. The parts covered by this specification document are subject to Mini-Circuits standard limited warranty and terms and conditions (collectively, "Standard Terms"); Purchasers of this part are entitled to the rights and benefits contained therein. For a full statement of the Standard Terms and the exclusive rights and remedies thereunder, please visit Mini-Circuits' website at [www.minicircuits.com/MCLStore/terms.jsp](http://www.minicircuits.com/MCLStore/terms.jsp)



# Ceramic Bandpass Filter

50Ω 2400 to 2500 MHz

## BFCG-252+



Generic photo used for illustration purposes only

CASE STYLE: GE0805C-3

### Features

- Miniature size 0805 (0.079"[2.0mm] x 0.049"[1.25mm] x 0.037"[0.95mm])
- High rejection
- Low cost
- Aqueous washable

**+RoHS Compliant**

The +Suffix identifies RoHS Compliance. See our web site for RoHS Compliance methodologies and qualifications

### Applications

- ISM Band
- WLAN
- Bluetooth
- Zigbee

### Electrical Specifications<sup>1,2</sup> at 25°C

Parameter	F#	Frequency (MHz)	Min.	Typ.	Max.	Unit	
Pass Band	Center Frequency	—	—	2450	—	dB	
	Insertion Loss	F1-F2	2400 - 2500	—	1.7	3.5	dB
	Return Loss	F1-F2	2400 - 2500	—	10	—	dB
Stop Band, Lower	Insertion Loss	DC-F3	10 - 1350	25	35	—	dB
Stop Band, Upper	Insertion Loss	F4-F5	3400 - 3800	23	27	—	dB
	Insertion Loss	F5-F6	3800 - 7000	30	36	—	dB
	Insertion Loss	F6-F7	7000 - 8000	27	36	—	dB

1. Tested on Evaluation Board TB-BFCG-252+

2. This Filter is not intended for use as DC Blocking circuits element. In Application where DC Voltage is present at either input or output ports, blocking capacitors are required at the corresponding RF ports.

### Functional Schematic

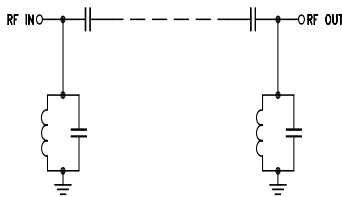

### Maximum Ratings

Operating Temperature	-55°C to 125°C
Storage Temperature <sup>3</sup>	-55°C to 125°C
RF Power Input <sup>4</sup>	2W at 25°C

3. Refer to product storage temperature after installation.

Suggestion for T&R unused product storage condition +5 - +35°C. Humidity 45-75% RH, 12 month Max.

4. Derate linearly to 0.5W @ 125°C.

Permanent damage may occur if any of these limits exceeded.

### Typical Frequency Response

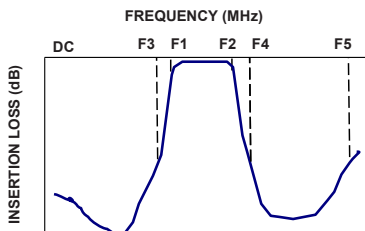

### Typical Performance Data at 25°C

Frequency (MHz)	Insertion Loss (dB)	Return Loss (dB)
10	76.14	0.05
100	54.55	0.05
500	42.58	0.06
1000	51.94	0.09
1500	29.33	0.15
1860	17.55	0.34
2000	12.54	0.69
2400	1.40	15.05
2500	1.56	13.76
3000	20.55	0.30
4000	42.69	0.21
5000	42.04	0.39
6000	52.98	0.39
7000	46.28	0.23
8000	33.64	0.29

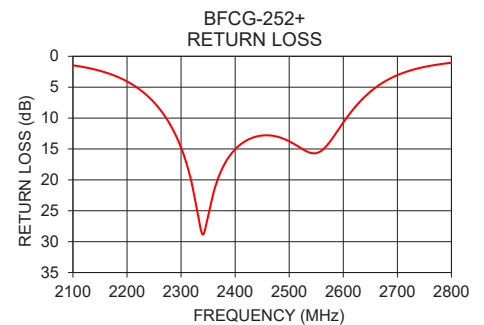
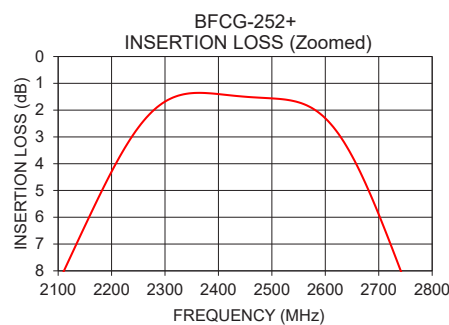
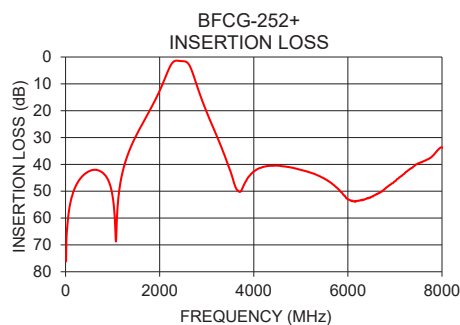

### Notes

A. Performance and quality attributes and conditions not expressly stated in this specification document are intended to be excluded and do not form a part of this specification document.

B. Electrical specifications and performance data contained in this specification document are based on Mini-Circuit's applicable established test performance criteria and measurement instructions.

C. The parts covered by this specification document are subject to Mini-Circuits standard limited warranty and terms and conditions (collectively, "Standard Terms"); Purchasers of this part are entitled to the rights and benefits contained therein. For a full statement of the Standard Terms and the exclusive rights and remedies thereunder, please visit Mini-Circuits' website at [www.minicircuits.com/MCLStore/terms.jsp](http://www.minicircuits.com/MCLStore/terms.jsp)



[www.minicircuits.com](http://www.minicircuits.com) P.O. Box 350166, Brooklyn, NY 11235-0003 (718) 934-4500 sales@minicircuits.com

REV. OR  
ECO-004694  
BFCG-252+  
RS/CP/AM  
201112  
Page 2 of 3

## Pad Connections

INPUT	1
OUTPUT	3
GROUND	2,4

## Product Marking: N/A

### Evaluation Board MCL P/N: TB-BFCG-252+ Suggested PCB Layout (PL-547)

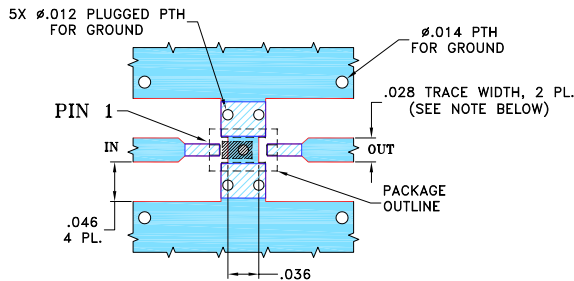

#### NOTES:

- TRACE WIDTH IS SHOWN FOR FR4, GRADE IT-180TC (ITEQ CORP.) WITH DIELECTRIC THICKNESS  $.016 \pm .0015$ . COPPER: 1/2 OZ., EACH SIDE. FOR OTHER MATERIALS TRACE WIDTH AND GAP MAY NEED TO BE MODIFIED.
- BOTTOM SIDE OF THE PCB IS CONTINUOUS GROUND PLANE.

- DENOTES PCB COPPER LAYOUT WITH SMOBC (SOLDER MASK OVER BARE COPPER).
- DENOTES COPPER LAND PATTERN FREE OF SOLDER MASK.

## Outline Drawing

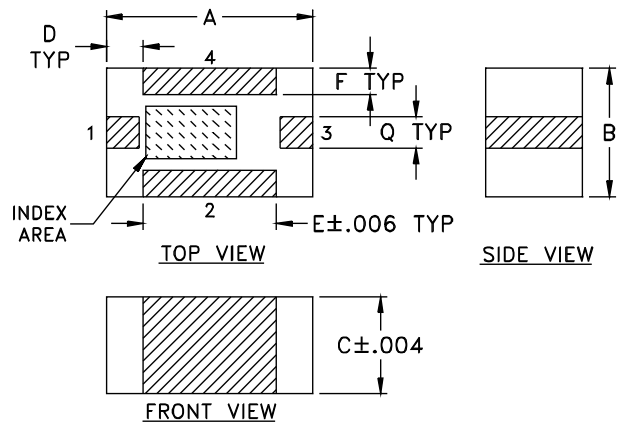

### Outline Dimensions ( $\frac{\text{inch}}{\text{mm}}$ )

A	B	C	D	E	F	Q	wt
.079	.049	.037	.014	.051	.010	.012	grams
2.01	1.24	0.94	0.36	1.30	0.25	0.30	.020

#### Notes

- Performance and quality attributes and conditions not expressly stated in this specification document are intended to be excluded and do not form a part of this specification document.
- Electrical specifications and performance data contained in this specification document are based on Mini-Circuit's applicable established test performance criteria and measurement instructions.
- The parts covered by this specification document are subject to Mini-Circuits standard limited warranty and terms and conditions (collectively, "Standard Terms"); Purchasers of this part are entitled to the rights and benefits contained therein. For a full statement of the Standard Terms and the exclusive rights and remedies thereunder, please visit Mini-Circuits' website at [www.minicircuits.com/MCLStore/terms.jsp](http://www.minicircuits.com/MCLStore/terms.jsp)

## X-ON Electronics

Largest Supplier of Electrical and Electronic Components

*Click to view similar products for [Signal Conditioning category](#):*

*Click to view products by [Mini-Circuits manufacturer](#):*

Other Similar products are found below :

[PD0409J5050S2HF](#) [HHS-109-PIN](#) [AFS14A35-1591.50-T3](#) [JP510S](#) [LFB322G45SN1A504](#) [SF2159E](#) [FM-104-PIN](#) [CER0813B](#)

[MAPDCC0005](#) [3A325](#) [BD0810N50100AHF](#) [DC0710J5005AHF](#) [DC2327J5005AHF](#) [LFL15869MTC1B787](#) [X3C19F1-20S](#)

[CDBLB455KCAX39-B0](#) [RF1353C](#) [051157-0000](#) [PD0922J5050D2HF](#) [600S150FTRB](#) [1E1305-3](#) [1F1304-3S](#) [TP-103-PIN](#)

[BD1222J50200AHF](#) [BD1722J50100AHF](#) [2450DP39K5400E](#) [BD0810J50150AHF](#) [BD1722J50200AHF](#) [DS-327-PIN](#) [MACP-008125-](#)

[CK07F0](#) [DS-329-PIN](#) [DS-313-PIN](#) [TP-104-PIN](#) [TP-101-PIN](#) [HH-128-PIN](#) [8594810000](#) [T-1000-N](#) [JP506S](#) [XC0900P-10S](#) [XC0900B-30S](#)

[CHE1260-QAG](#) [11305-10](#) [5962-9091202MXA](#) [3A412S](#) [X3C06A4-03S](#) [B39000Z3410A4](#) [DSS-333-PIN](#) [PD2425J5050S2HF](#)

[B39242B4360P810](#) [B39781B8005P810](#)