

LTCC Bandpass Filter

BFCN-1052+

50Ω 9700 to 11950 MHz



CASE STYLE: FV1206-9

The Big Deal

- Small size 3.2mm x 1.6mm
- Low loss in passband (1.5 dB typ over 9700 to 11950 MHz)
- Very high rejection over wide band

Product Overview

The BFCN-1052+ LTCC bandpass Filter achieves a miniature size and high repeatability of performance. Wrap-around terminations minimize variations in performance due to parasitics. Passing 9700-11950 MHz, these units offer excellent rejection over a wide stopband.

Key Features	Advantages
Small Size (3.20mm x1.6 mm)	Allows for high layout density of circuit boards, while minimizing effects of parasitics.
Rejection peaks close to pass band	Provides good rejection of signals close to the pass band, for improved system performance.
Wide stopband	Reduced regrowth at 2nd harmonic permits filter to be used in presence of wideband undesired signals.
LTCC construction	Provides a rugged package that is well suited for tough environments including high humidity and high temperature extremes.

Ceramic

Bandpass Filter

50Ω 9700 to 11950 MHz

BFCN-1052+



Generic photo used for illustration purposes only

CASE STYLE: FV1206-9

+RoHS Compliant

The +Suffix identifies RoHS Compliance. See our web site for RoHS Compliance methodologies and qualifications



Available Tape and Reel at no extra cost

Reel Size	Devices/Reel
7"	20, 50, 100, 200, 500, 1000, 3000

Features

- Small size
- Temperature stable
- Hermetically sealed
- LTCC construction

Applications

- Harmonic Rejection
- Transmitters / Receivers
- Test and Measurement

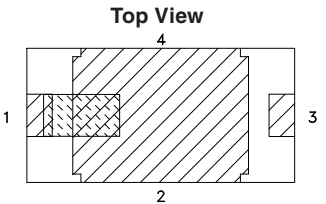
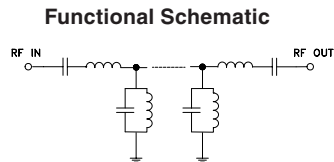
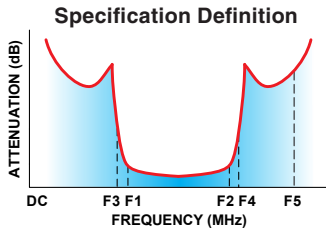

Pad Connections	
Input	1
Output	3
Ground	2

Electrical Specifications^(1,2) at 25°C

Parameter	F#	Frequency (MHz)	Min.	Typ.	Max.	Unit	
Pass Band	Center Frequency	—	—	10770	—	MHz	
	Insertion Loss	F1-F2	9700-11950	—	1.6	3.0	dB
	VSWR	F1-F2	9700-11950	—	1.9	—	:1
Stop Band, Lower	Insertion Loss	DC-F3	DC-8100	30	38	—	dB
	Insertion Loss	—	8100-8400	20	32	—	dB
Stop Band, Upper	Insertion Loss	F4-F5	14000-28500	20	28	—	dB
	Insertion Loss	F5-F6	28500-44000	—	25	—	dB

1. Measured on Mini-Circuits Characterization Test Board TB-1003+ with feedline losses removed by normalization of S12 and S21 traces to measurement of TB thru-line.

2. This filter can not be used as a DC Blocking circuit element. In applications where DC voltage is present at either input or output ports, blocking capacitors are required at the corresponding RF port.

Maximum Ratings

Operating Temperature	-55°C to +100°C
Storage Temperature	-55°C to +100°C
RF Power Input*	2W at 25°C

*Passband rating, derate linearly to 0.5W at 100°C ambient
Permanent damage may occur if any of these limits are exceeded.

Typical Performance Data at 25°C

Frequency (GHz)	Insertion Loss (dB)	VSWR (:1)
1	-67.66	50.51
5	-53.39	26.26
8	-37.87	16.83
9	-12.22	7.04
10	-1.28	1.06
11	-1.38	1.63
12	-1.43	1.57
13	-13.21	5.03
15	-43.13	9.36
17	-37.34	11.85
20	-31.96	9.70
25	-28.59	6.41
35	-32.06	6.05
40	-40.15	5.17
41	-35.93	4.53

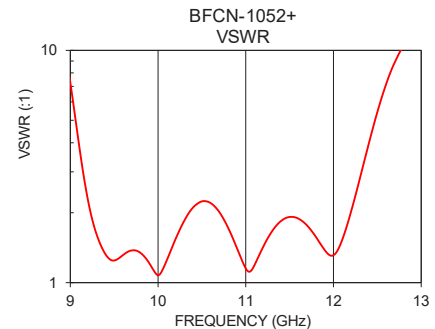
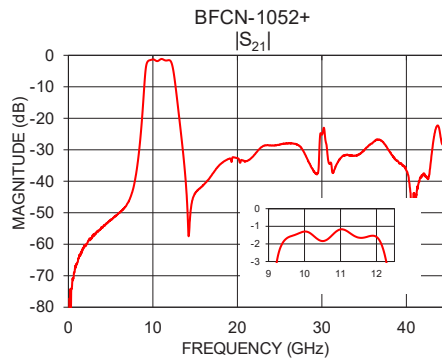

Bandpass Filter

BFCN-1052+

Outline Drawing

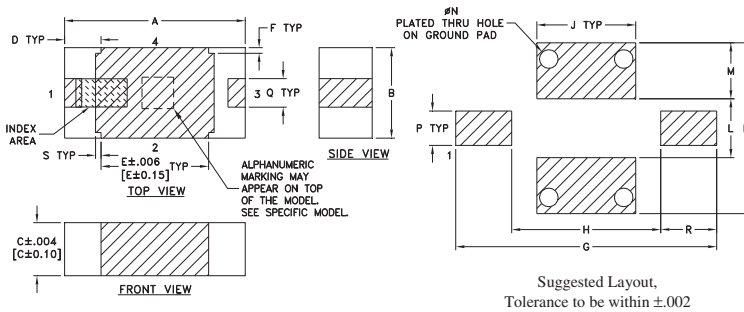

Pad Connections

Input	1
Output	3
Ground	2

Product Marking: KL

Outline Dimensions ($\frac{\text{inch}}{\text{mm}}$)

A	B	C	D	E	F	G	H	J
.126	.063	.037	.026	.075	.004	.182	.104	.069
3.20	1.60	0.94	0.66	1.91	0.10	4.62	2.64	1.753
K	L	M	N	P	Q	R	S	wt
0.119	0.041	.039	.013	.024	.020	.039	.004	grams
3.023	1.041	0.99	0.33	0.61	0.51	0.99	0.10	.020

Demo Board MCL P/N: TB-1003 + Suggested PCB Layout (PL-610)

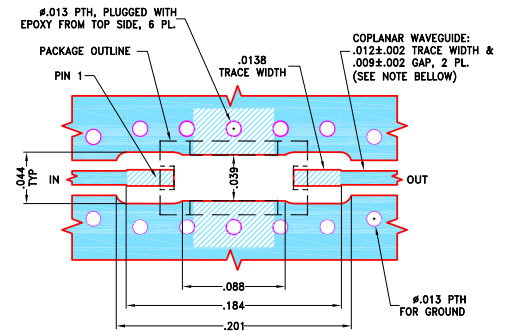

NOTES:

- TRACE WIDTH AND GAP PARAMETERS ARE SHOWN FOR ROGERS RO4350B WITH DIELECTRIC THICKNESS .0066"±.0007", COPPER: 1/2 OZ. EACH SIDE. FOR OTHER MATERIALS TRACE WIDTH AND GAP MAY NEED TO BE MODIFIED.
 - BOTTOM SIDE OF THE PCB IS CONTINUOUS GROUND PLANE.
 - UNIT LAND PATTERN WAS OPTIMIZED FOR BETTER PERFORMANCE.
- DENOTES PCB COPPER LAYOUT WITH SMOBC (SOLDER MASK OVER BARE COPPER).
 DENOTES COPPER LAND PATTERN FREE OF SOLDER MASK.

Additional Notes

- Performance and quality attributes and conditions not expressly stated in this specification document are intended to be excluded and do not form a part of this specification document.
- Electrical specifications and performance data contained in this specification document are based on Mini-Circuit's applicable established test performance criteria and measurement instructions.
- The parts covered by this specification document are subject to Mini-Circuits standard limited warranty and terms and conditions (collectively, "Standard Terms"); Purchasers of this part are entitled to the rights and benefits contained therein. For a full statement of the Standard Terms and the exclusive rights and remedies thereunder, please visit Mini-Circuits' website at www.minicircuits.com/MCLStore/terms.jsp



X-ON Electronics

Largest Supplier of Electrical and Electronic Components

Click to view similar products for [Signal Conditioning](#) category:

Click to view products by [Mini-Circuits](#) manufacturer:

Other Similar products are found below :

[MAPDCC0001](#) [MAPDCC0004](#) [PD0409J5050S2HF](#) [880157](#) [HHS-109-PIN](#) [DC1417J5005AHF](#) [AFS14A30-2185.00-T3](#) [AFS14A35-1591.50-T3](#) [DS-323-PIN](#) [B39321R801H210](#) [1A0220-3](#) [JP510S](#) [LFB212G45SG8C341](#) [LFB322G45SN1A504](#) [LFL182G45TC3B746](#) [SF2159E](#) [30057](#)
[FM-104-PIN](#) [CER0813B](#) [MAPDCC0005](#) [3A325](#) [40287](#) [41180](#) [ATB3225-75032NCT](#) [BD0810N50100AHF](#) [BD2425J50200AHF](#)
[C5060J5003AHF](#) [JHS-115-PIN](#) [JP503AS](#) [DC0710J5005AHF](#) [DC2327J5005AHF](#) [DC3338J5005AHF](#) [43020](#) [LFB2H2G60BB1C106](#)
[LFL15869MTC1B787](#) [X3C19F1-20S](#) [XC3500P-20S](#) [10013-20](#) [SF2194E](#) [CDBLB455KCAX39-B0](#) [TGL2208-SM, EVAL](#) [RF1353C](#)
[PD0922J5050D2HF](#) [1E1305-3](#) [1G1304-30](#) [B0922J7575AHF](#) [2020-6622-20](#) [TP-102-PIN](#) [TP-103-PIN](#) [BD1222J50200AHF](#)