

Ceramic

Bandpass Filter

BFTC-415+

50Ω

330 to 500 MHz

The Big Deal

- LTCC construction
- Temperature stable from -40°C to +85°C
- Small size (0.150 x 0.150 x 0.059")



Generic photo used for illustration purposes only
CASE STYLE: FR933-1

Product Overview

The BFTC-415+ LTCC bandpass filter covers the 330 to 500 MHz passband with 25 dB upper/lower stopband rejection. This model handles up to 4W RF input power and provides a wide operating temperature range from -40 to +85°C. Utilizing LTCC multi-layer construction, the filter achieves excellent repeatability of performance and comes in a tiny ceramic package saving space in dense PCB layouts.

Key Features

Feature	Advantages
LTCC Construction	Provides a rugged package well suited for tough environments such as high humidity and temperature extremes.
Tiny size (0.150 x 0.150 x 0.059")	Saves space in dense circuit boards and minimizes the effects of parasitics.
Wide operating temperature range, -40 to +85°C	Enables reliable performance in extreme environments

Notes

- A. Performance and quality attributes and conditions not expressly stated in this specification document are intended to be excluded and do not form a part of this specification document.
B. Electrical specifications and performance data contained in this specification document are based on Mini-Circuit's applicable established test performance criteria and measurement instructions.
C. The parts covered by this specification document are subject to Mini-Circuits standard limited warranty and terms and conditions (collectively, "Standard Terms"); Purchasers of this part are entitled to the rights and benefits contained therein. For a full statement of the Standard Terms and the exclusive rights and remedies thereunder, please visit Mini-Circuits' website at www.minicircuits.com/MCLStore/terms.jsp



Ceramic Bandpass Filter

50Ω 330 to 500 MHz

BFTC-415+



Generic photo used for illustration purposes only
CASE STYLE: FR933-1

Features

- Good VSWR 1.5 typ. @ passband
- Small size
- Hermetically sealed
- Temperature stable
- LTCC construction

Applications

- Test and measurement
- Harmonic rejection
- Transmitters / Receivers

Electrical Specifications^{1,2} at 25°C

Parameter	F#	Frequency (MHz)	Min.	Typ.	Max.	Unit
Pass Band	Center Frequency	—	—	415	—	MHz
	Insertion Loss	F1-F2	—	4.0	5.5	dB
	VSWR	F1-F2	330-500	—	1.5	:1
Stop Band, Lower	Insertion Loss	F3-F4	1-240	25	36	dB
	VSWR	F3-F4	1-240	—	18	:1
Stop Band, Upper	Insertion Loss	F5-F6	650-1800	25	36	dB
	VSWR	F5-F6	650-1800	—	10	:1

1. Measured on Mini-Circuits Characterization Test Board TB-233

2. This filter is not intended for use as a DC Blocking circuit element. In Application where DC voltage is present at either input or output ports, blocking capacitors are required at the corresponding RF port.

Maximum Ratings

Operating Temperature	-40°C to 85°C
Storage Temperature	-55°C to 100°C
RF Power Input*	4W max @ +25°C

*Passband rating, derate linearly to 2W at 85°C ambient

Permanent damage may occur if any of these limits are exceeded.

Functional Schematic

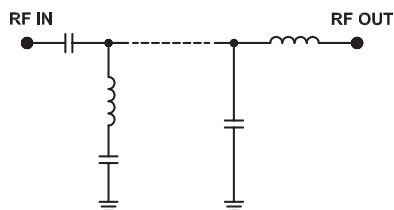

Typical Frequency Response

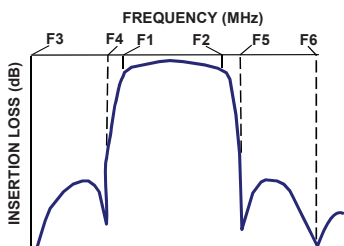

Typical Performance Data at 25°C

Frequency (MHz)	Insertion Loss (dB)	VSWR (:1)	Frequency (MHz)	Group Delay (nsec)
1	82.97	6144.30	330	7.27
10	63.43	2622.39	334	6.91
100	45.44	35.84	338	6.59
240	38.50	8.47	340	6.45
252	30.02	7.76	350	5.87
268	20.84	6.49	360	5.45
290	10.17	3.68	370	5.14
310	4.56	1.59	380	4.90
330	3.04	1.04	390	4.72
415	2.46	1.16	410	4.53
500	3.92	1.09	415	4.51
530	6.62	1.72	420	4.50
550	10.97	3.04	430	4.51
580	20.00	5.89	440	4.54
616	30.25	9.21	450	4.62
650	37.22	12.18	460	4.73
750	54.87	21.24	470	4.90
1000	38.23	39.93	480	5.13
1500	41.96	52.16	490	5.44
1800	43.43	53.55	500	5.85

+RoHS Compliant

The +Suffix identifies RoHS Compliance. See our web site for RoHS Compliance methodologies and qualifications

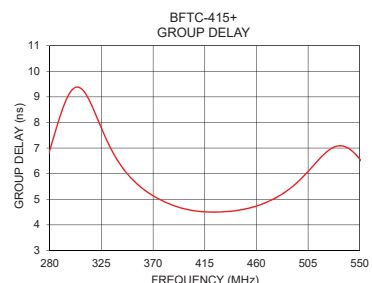
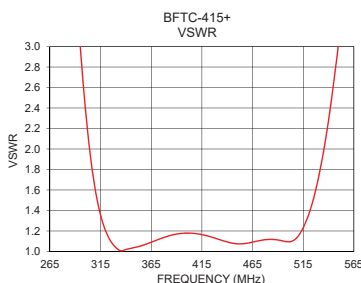
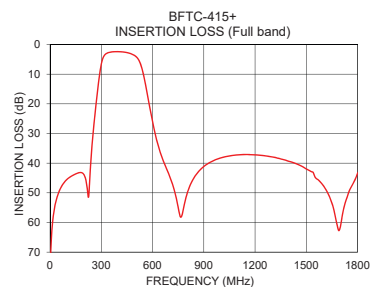
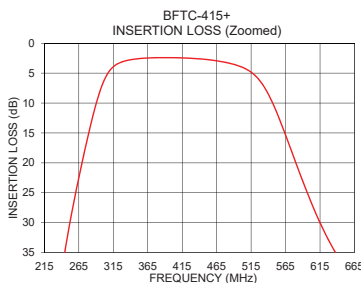

Notes

- Performance and quality attributes and conditions not expressly stated in this specification document are intended to be excluded and do not form a part of this specification document.
- Electrical specifications and performance data contained in this specification document are based on Mini-Circuit's applicable established test performance criteria and measurement instructions.
- The parts covered by this specification document are subject to Mini-Circuits standard limited warranty and terms and conditions (collectively, "Standard Terms"); Purchasers of this part are entitled to the rights and benefits contained therein. For a full statement of the Standard Terms and the exclusive rights and remedies thereunder, please visit Mini-Circuits' website at www.minicircuits.com/MCLStore/terms.jsp



Pad Connections

RF IN	2
RF OUT	5
GROUND	1,3,4,6

Product Marking: 347

Demo Board MCL P/N: TB-233
Suggested PCB Layout (PL-112)

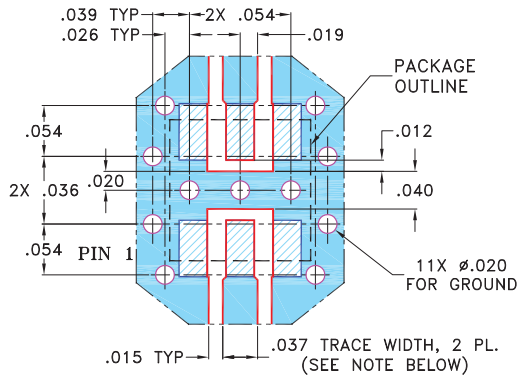

NOTES: 1. TRACE WIDTH IS SHOWN FOR ROGERS R04350B WITH DIELECTRIC THICKNESS $0.020" \pm 0.0015"$; COPPER: 1/2 OZ. EACH SIDE. FOR OTHER MATERIALS TRACE WIDTH MAY NEED TO BE MODIFIED.

2. BOTTOM SIDE OF THE PCB IS CONTINUOUS GROUND PLANE.

- DENOTES PCB COPPER LAYOUT WITH SMOBC (SOLDER MASK OVER BARE COPPER)
- DENOTES COPPER LAND PATTERN FREE OF SOLDER MASK

Outline Drawing

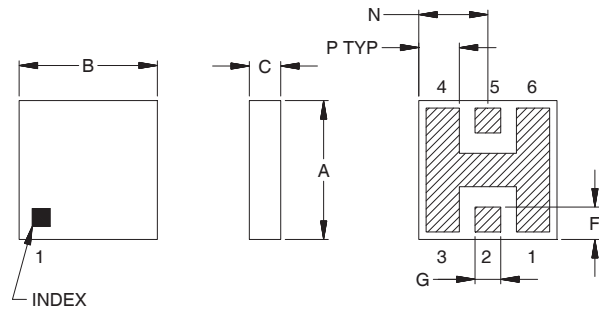

PCB Land Pattern

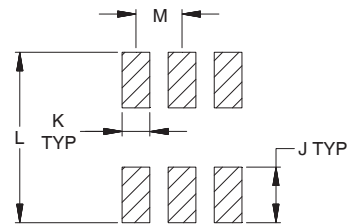

Suggested Layout,
Tolerance to be within $\pm .002$

Outline Dimensions (inch/mm)

A	B	C	D	E	F	G	H
.150	.150	.059	--	--	.035	.028	--
3.81	3.81	1.50	--	--	.89	.71	--
J	K	L	M	N	P	Wt.	
.060	.030	.184	.050	.075	.044	grams	
1.52	.76	4.67	1.27	1.91	1.12	0.15	

Note: Please refer to case style drawing for details

Notes

- A. Performance and quality attributes and conditions not expressly stated in this specification document are intended to be excluded and do not form a part of this specification document.
- B. Electrical specifications and performance data contained in this specification document are based on Mini-Circuit's applicable established test performance criteria and measurement instructions.
- C. The parts covered by this specification document are subject to Mini-Circuits standard limited warranty and terms and conditions (collectively, "Standard Terms"); Purchasers of this part are entitled to the rights and benefits contained therein. For a full statement of the Standard Terms and the exclusive rights and remedies thereunder, please visit Mini-Circuits' website at www.minicircuits.com/MCLStore/terms.jsp

X-ON Electronics

Largest Supplier of Electrical and Electronic Components

Click to view similar products for [Signal Conditioning](#) category:

Click to view products by [Mini-Circuits](#) manufacturer:

Other Similar products are found below :

[PD0409J5050S2HF](#) [HHS-109-PIN](#) [AFS14A35-1591.50-T3](#) [JP510S](#) [LFB322G45SN1A504](#) [SF2159E](#) [FM-104-PIN](#) [CER0813B](#)
[MAPDCC0005](#) [3A325](#) [BD0810N50100AHF](#) [DC0710J5005AHF](#) [DC2327J5005AHF](#) [LFL15869MTC1B787](#) [X3C19F1-20S](#)
[CDBLB455KCAX39-B0](#) [RF1353C](#) [051157-0000](#) [PD0922J5050D2HF](#) [600S150FTRB](#) [1E1305-3](#) [1F1304-3S](#) [TP-103-PIN](#)
[BD1222J50200AHF](#) [BD1722J50100AHF](#) [2450DP39K5400E](#) [BD0810J50150AHF](#) [BD1722J50200AHF](#) [DS-327-PIN](#) [MACP-008125-](#)
[CK07F0](#) [DS-329-PIN](#) [DS-313-PIN](#) [TP-104-PIN](#) [TP-101-PIN](#) [HH-128-PIN](#) [8594810000](#) [T-1000-N](#) [JP506S](#) [XC0900P-10S](#) [XC0900B-30S](#)
[CHE1260-QAG](#) [11305-10](#) [5962-9091202MXA](#) [3A412S](#) [X3C06A4-03S](#) [B39000Z3410A4](#) [DSS-333-PIN](#) [PD2425J5050S2HF](#)
[B39242B4360P810](#) [B39781B8005P810](#)