

Flat Gain, High IP3

Monolithic Amplifier

CMA-63+

50Ω 0.01 to 6 GHz

The Big Deal

- Ceramic, Hermetically Sealed, Nitrogen filled
- Low profile case, .045" high
- High Gain
- Broadband High Dynamic Range without external Matching Components



CASE STYLE: DL1721

MIL Screening Available
Please consult Applications Dept.

Product Overview

CMA-63+ (RoHS compliant) is a wideband amplifier fabricated using HBT technology and offers high gain over a broad frequency range and with high IP3. In addition, the CMA-63+, has good input and output return loss over a broad frequency range without the need for external matching components and has demonstrated excellent reliability. The MMIC amplifier is bonded to a multilayer integrated LTCC substrate, and then hermetically sealed under a controlled nitrogen atmosphere with gold-plated covers and eutectic AuSn solder. These amplifiers are capable of meeting MIL requirements for gross leak, fine leak, thermal shock, vibration, acceleration, mechanical shock, and HTOL. The testing can be done if requested.

Key Features

Feature	Advantages
Broad Band: 0.01 to 6.0 GHz	Broadband covering primary wireless communications bands: Cellular, PCS, LTE, WiMAX, SATELLITE IF
Flat Gain	±1.5 dB over 50 to 3000 MHz; eliminates need for gain flattening for most applications
High IP3 vs. DC power Consumption 35 dBm typical at 0.05 GHz 35 dBm typical at 0.8 GHz	The CMA-63+ matches industry leading IP3 performance relative to device size and power consumption. The combination of the design and HBT Structure provides enhanced linearity over a broad frequency range as evidence in the IP3 being typically 16 dB above the P 1dB point to 0.8 GHz. This feature makes this amplifier ideal for use in: <ul style="list-style-type: none">• Driver amplifiers for complex waveform up converter paths• Drivers in linearized transmit systems
No External Matching Components Required	CMA-63+ provides Input and Output Return Loss of 15 dB up to 3 GHz without the need for any external matching components
Ceramic Hermetic Package	Low Inductance, repeatable performance, excellent reliability.

Notes

- A. Performance and quality attributes and conditions not expressly stated in this specification document are intended to be excluded and do not form a part of this specification document.
B. Electrical specifications and performance data contained in this specification document are based on Mini-Circuit's applicable established test performance criteria and measurement instructions.
C. The parts covered by this specification document are subject to Mini-Circuits standard limited warranty and terms and conditions (collectively, "Standard Terms"); Purchasers of this part are entitled to the rights and benefits contained therein. For a full statement of the Standard Terms and the exclusive rights and remedies thereunder, please visit Mini-Circuits' website at www.minicircuits.com/MCLStore/terms.jsp



Flat Gain, High IP3

Monolithic Amplifier

0.01-6 GHz

Product Features

- Flat Gain, ± 1.0 dB over 50-3000 MHz
- Gain, 20 dB typ. at 2 GHz
- High Pout, P1dB 18.4 dBm typ. at 2 GHz
- High IP3, 34.6 dBm typ. at 50 MHz; 32.0 dBm at 2GHz
- Excellent ESD protection, Class 1C for HBM
- Small size - 3mm x 3mm x 1.14mm
- Ceramic, hermetic, Nitrogen filled
- No external matching components required
- May be used as a replacement for SPF5043Z ^{a,b}



Generic photo used for illustration purposes only

CASE STYLE: DL1721

CMA-63+

+RoHS Compliant

The +Suffix identifies RoHS Compliance. See our web site for RoHS Compliance methodologies and qualifications

Typical Applications

- Base station infrastructure
- Portable Wireless
- CATV & DBS
- MMDS & Wireless LAN
- LTE

General Description

CMA-63+ (RoHS compliant) is an advanced wideband amplifier fabricated using HBT technology and offers ultra flat gain over a broad frequency range and with high IP3. In addition, the CMA-63+ has good input and output return loss over a broad frequency range without the need for external matching components. Terminal finish is Ni-pd-Au and it has repeatable performance from lot to lot due to fully automated, tightly controlled semiconductor and assembly processes.

simplified schematic and pin description

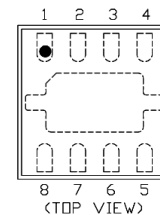
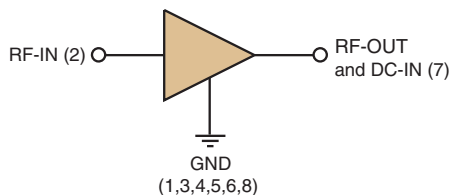

Function	Pin Number	Description
RF IN	2	RF input pin. This pin requires the use of an external DC blocking capacitor chosen for the frequency of operation.
RF-OUT and DC-IN	7	RF output and bias pin. DC voltage is present on this pin; therefore a DC blocking capacitor is necessary for proper operation. An RF choke is needed to feed DC bias without loss of RF signal due to the bias connection, as shown in "Recommended Application Circuit", Fig. 2
GND	1,3,4,5,6,8, Bottom Center Paddle	Connections to ground. Use via holes as shown in "Suggested Layout for PCB Design" to reduce ground path inductance for best performance.

Notes

- A. Performance and quality attributes and conditions not expressly stated in this specification document are intended to be excluded and do not form a part of this specification document.
 B. Electrical specifications and performance data contained in this specification document are based on Mini-Circuits' applicable established test performance criteria and measurement instructions.
 C. The parts covered by this specification document are subject to Mini-Circuits standard limited warranty and terms and conditions (collectively, "Standard Terms"); Purchasers of this part are entitled to the rights and benefits contained therein. For a full statement of the Standard Terms and the exclusive rights and remedies thereunder, please visit Mini-Circuits' website at www.minicircuits.com/MCLStore/terms.jsp



Electrical Specifications^{1,2} at 25°C, unless noted

Parameter	Condition (GHz)	Min.	Typ.	Max.	Units
Frequency Range ²		0.01		6	GHz
Gain	0.05	19.0	21.9		dB
	0.8		21.2		
	2.0		20.3		
	3.0		19.0		
	4.0		17.5		
	6.0		14.4		
Gain Flatness	0.05 - 3.0		±1.5		dB
	0.7 - 2.6		±1.2		
Input Return Loss	0.05		16.6		dB
	0.8		20.2		
	2.0		30.0		
	3.0		16.2		
	4.0		11.5		
	6.0		8.9		
Output Return Loss	0.05		15.9		dB
	0.8		19.8		
	2.0		14.9		
	3.0		15.8		
	4.0		16.2		
	6.0		18.5		
Reverse Isolation	2.0		23.7		dB
Output Power @1 dB compression	0.05		18.7		dBm
	0.8		18.9		
	2.0		18.4		
	3.0		16.3		
	4.0		14.3		
	6.0		11.7		
Output IP3	0.05		34.6		dB
	1.0		34.4		
	2.0		32.0		
	3.0		29.2		
	4.0		27.5		
	6.0		25.3		
Noise Figure	0.05		3.7		dB
	1.0		3.9		
	2.0		3.9		
	3.0		3.9		
	4.0		4.1		
	6.0		4.6		
Device Operating Voltage		4.8	5.0	5.2	V
Device Operating Current		58	69	78	mA
Device Current Variation vs. Temperature ³			62		µA/°C
Device Current Variation vs. Voltage			0.035		mA/mV
Thermal Resistance, junction-to-ground lead			64		°C/W

(1) Measured on Mini-Circuits Characterization test board TB-656-63+. See Characterization Test Circuit (Fig. 1)

(2) Low Frequency cut-off determined by external coupling capacitors and external bias choke.

(3) (Current at 85°C — Current at -45°C)/130

Absolute Maximum Ratings

Parameter	Ratings
Operating Temperature (ground lead)	-55°C to 85°C
Storage Temperature	-65°C to 125°C
Operating Current at 5V	120 mA
Power Dissipation	0.5 W
Input Power (CW)	13 dBm
DC Voltage on Pin 3	6V

Note:

Permanent damage may occur if any of these limits are exceeded. Electrical maximum ratings are not intended for continuous normal operation. For continuous operation, do not exceed 5.2V device voltage.

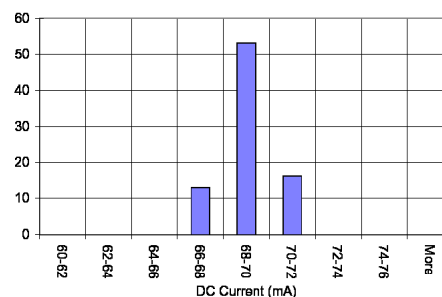

Notes

- A. Performance and quality attributes and conditions not expressly stated in this specification document are intended to be excluded and do not form a part of this specification document.
- B. Electrical specifications and performance data contained in this specification document are based on Mini-Circuit's applicable established test performance criteria and measurement instructions.
- C. The parts covered by this specification document are subject to Mini-Circuits standard limited warranty and terms and conditions (collectively, "Standard Terms"); Purchasers of this part are entitled to the rights and benefits contained therein. For a full statement of the Standard Terms and the exclusive rights and remedies thereunder, please visit Mini-Circuits' website at www.minicircuits.com/MCLStore/terms.jsp



Characterization Test Circuit

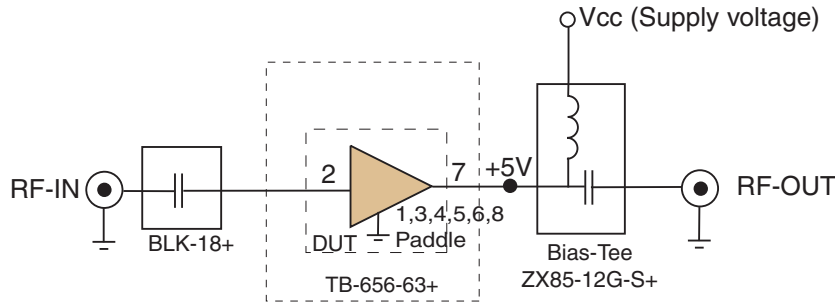

Fig 1. Block Diagram of Test Circuit used for characterization. (DUT soldered on Mini-Circuits Characterization test board TB-656-63+) Gain, Return loss, Output power at 1dB compression (P1 dB) , output IP3 (OIP3) and noise figure measured using Agilent’s N5242A PNA-X microwave network analyzer.

Conditions:

1. Gain and Return loss: Pin= -25dBm
2. Output IP3 (OIP3): Two tones, spaced 1 MHz apart, 0 dBm/tone at output.

Recommended Application Circuit

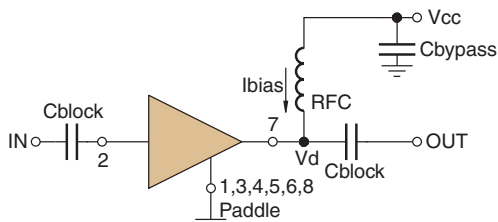
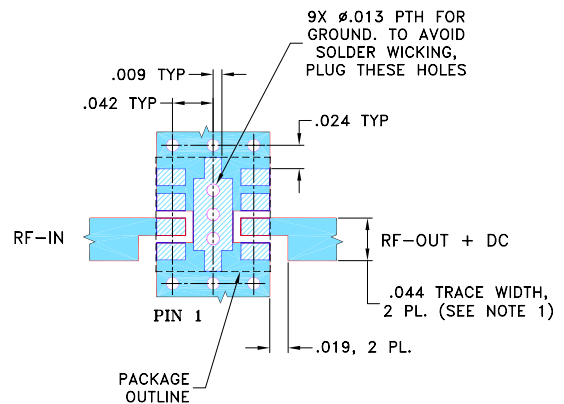

Fig 2. Test Board includes case, connectors, and components soldered to PCB for component values, please see evaluation board drawing.

Suggested PCB Layout (PL-366)



NOTES:

1. TRACE WIDTH IS SHOWN FOR ROGERS R04350B WITH DIELECTRIC THICKNESS .020" ± .0015"; COPPER: 1/2 OZ. EACH SIDE. FOR OTHER MATERIALS TRACE WIDTH AND GAP MAY NEED TO BE MODIFIED.
2. BOTTOM SIDE OF THE PCB IS CONTINUOUS GROUND PLANE.

- DENOTES PCB COPPER LAYOUT WITH SMOBC (SOLDER MASK OVER BARE COPPER)
- DENOTES COPPER LAND PATTERN FREE OF SOLDER MASK

Product Marking

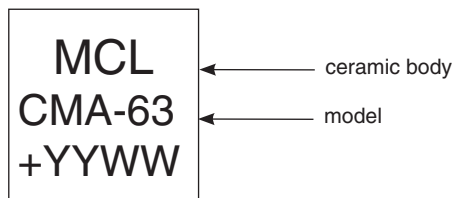

Notes

- A. Performance and quality attributes and conditions not expressly stated in this specification document are intended to be excluded and do not form a part of this specification document.
- B. Electrical specifications and performance data contained in this specification document are based on Mini-Circuit's applicable established test performance criteria and measurement instructions.
- C. The parts covered by this specification document are subject to Mini-Circuits standard limited warranty and terms and conditions (collectively, "Standard Terms"); Purchasers of this part are entitled to the rights and benefits contained therein. For a full statement of the Standard Terms and the exclusive rights and remedies thereunder, please visit Mini-Circuits' website at www.minicircuits.com/MCLStore/terms.jsp



Additional Detailed Technical Information	
<i>additional information is available on our dash board. To access this information click here</i>	
Performance Data	Data Table
	Swept Graphs
	S-Parameter (S2P Files) Data Set (.zip file)
Case Style	DL1721 <i>Ceramic package, exposed paddle, Terminal finish: Ni,Pd,Au</i>
Tape & Reel Standard quantities available on reel	F66-1 <i>7" reels with 20, 50, 100, 200, 500 or 1K, 2K devices.</i>
Suggested Layout for PCB Design	PL-366
Evaluation Board	TB-656-63+
Environmental Ratings	ENV-68

ESD Rating

Human Body Model (HBM): Class 1C (1000 to <2000V) in accordance with ANSI/ESD STM 5.1 - 2001

Machine Model (MM): Class M2 (100 to <200V) in accordance with ANSI/ESD STM5.2-1999

MSL Rating

Moisture Sensitivity: MSL1 (these parts are hermetic, air cavity and therefore, MSL ratings do not strictly apply. For handling purpose, use MSL1)

Qualification Testing

The table below shows the initial qualification testing performed. If required, parts can be subjected to 100% screening and qualifications testing per MIL standard requirement.

Test Description		Test Method/Process	Results
1	Hermeticity (fine and gross leak)	MIL-STD-202 Method 112, Cond. C & D	Pass
2	Acceleration, 30Kg, Y1 Direction	MIL-STD-883 Method 2001 Cond. E	Pass
3	Vibration , 10-2000Hz sine, 20g, 3 axis	MIL-STD-202 Method 204, Cond. D	Pass
4	Mechanical shock	MIL-STD-202 Method 213, Cond . A	Pass
5	PIND 20G's @ 130 Hz	MIL-STD-750 Method 2052.2	Pass
6	Temp Cycle -55C/+125C, 1000 Cycles	MIL-STD-202 Method 107	Pass
7	Autoclave, 121C, RH 100%, 15 Psig, 96 hrs	JESD22-A102C	Pass
8	HTOL, 1000hrs, 105C at rated Voltage condition	MIL-STD-202 Method 108, Cond . D	Pass
9	Bend Test	JESD22-B113	Pass
10	Resistance to soldering heat, 3x reflow, 260C peak	JESD22-B102	Pass
11	Drop Test	JESD22-B111	Pass
12	Adhesion Strength	Push Test>10 lb	Pass

Notes

- A. Performance and quality attributes and conditions not expressly stated in this specification document are intended to be excluded and do not form a part of this specification document.
- B. Electrical specifications and performance data contained in this specification document are based on Mini-Circuit's applicable established test performance criteria and measurement instructions.
- C. The parts covered by this specification document are subject to Mini-Circuits standard limited warranty and terms and conditions (collectively, "Standard Terms"); Purchasers of this part are entitled to the rights and benefits contained therein. For a full statement of the Standard Terms and the exclusive rights and remedies thereunder, please visit Mini-Circuits' website at www.minicircuits.com/MCLStore/terms.jsp



X-ON Electronics

Largest Supplier of Electrical and Electronic Components

Click to view similar products for [RF Amplifier](#) category:

Click to view products by [Mini-Circuits](#) manufacturer:

Other Similar products are found below :

[A1212](#) [AL7](#) [SE2433T-R](#) [SMA3101-TL-E](#) [A66-1](#) [A66-3](#) [A81-2](#) [LX5535LQ](#) [SMA411](#) [SMA531](#) [SST12LP19E-QX6E](#) [WPM0510A](#)
[MMZ25332B4T1](#) [SMA1212](#) [MAAMSS0041TR](#) [MAAM37000-A1G](#) [SMA88-1](#) [SMA4011](#) [A231](#) [UA5M20MC](#) [XD1001-BD-000V](#)
[BGU6009/N2X](#) [BGS8H2X](#) [BGS8324Z](#) [SMA66](#) [A12](#) [MMA022AA](#) [MAAP-015024-DIE](#) [AMS-162-PIN](#) [CA70-2](#) [MMG30301BT1](#) [LA17](#)
[MMA041PP5](#) [MAMF-011119-TR1000](#) [A57](#) [GRF2011](#) [MMA044PP3](#) [ISL55007IEZ-T7](#) [ISL55008IEZ-T7](#) [ISL55009IEZ-T7](#) [ISL55010IEZ-T7](#) [ISL55011IEZ-T7](#) [NSVG3117SG6T1G](#) [BGA7H1BN6E6327](#) [BGA125N6E6327XTSA1](#) [TSS-23LN+](#) [TRF1305B2RYPR](#) [TRF1208RPVT](#)
[LTC6433AIUF-15#PBF](#) [HMC797APM5ETR-R5](#)