

Microwave Gain Equalizers

EQY-XX-24+ Series

50Ω DC to 20 GHz



CASE STYLE: MC1631-1

The Big Deal

- Excellent Return Loss, 20dB typ.
- Wide bandwidth, DC - 20 GHz
- Small Size, 2 mm x 2 mm

Product Overview

EQY-XX-24+ Series of absorptive Gain Equalizers are fabricated using highly repetitive GaAs IPD* MMIC process incorporating resistors, capacitors and inductors having negative insertion loss slope. EQYs are available with nominal attenuation slope of 0,2,3,5,6,8,10,12 dB. They are packaged in tiny 2 x 2 mm 8-Lead MCLP™ package.

Key Features

Feature	Advantages
Negative Insertion Loss Slope vs. Frequency	Useful for compensating negative gain slope of amplifiers, receivers, transmitters to achieve flat gain versus frequency.
Wide range of values 0,2,3,5,6,8,10,12 dB	Enables circuit designer to change nominal insertion loss values without mother-board redesign making the EQY-XX-24+ Series ideal for select at test application.
Wideband operation, DC to 20 GHz	Supports a wide array of applications including wireless cellular, microwave communications, satellite, defense and aerospace, medical broadband and optic applications.
Excellent Power Handling Capability	Enables its use at the output of a variety of amplifiers
Small Size and simple to use (2 mm x 2 mm)	As a single chip solution, the EQY-XX-24+ Series occupies less board space than a lumped element approach, minimizes component count and ensures repeatable performance over wide frequency range.

*GaAs IPD (Gallium Arsenide Integrated Passive Device)

Microwave Gain Equalizer

EQY-10-24+

50Ω 10dB DC to 20 GHz

Product Features

- 10.2 dB Slope
- Small Package 2 x 2 mm MCLP
- Wide Bandwidth, DC-20 GHz
- Excellent Return Loss, 20 dB typ.

Typical Applications

- Fixed Satellite
- Mobile
- Radio location
- Space research



Generic photo used for illustration purposes only

CASE STYLE: MC1631-1

+RoHS Compliant

The +Suffix identifies RoHS Compliance. See our web site for RoHS Compliance methodologies and qualifications

General Description

EQY-10-24+ is an absorptive Gain Equalizer fabricated using highly repetitive GaAs IPD MMIC process incorporating resistors, capacitors and inductors having negative insertion loss slope. EQY-10-24+ has a nominal attenuation slope of 10.2 dB and is packaged in tiny 2 x 2 mm, 8-Lead MCLP™ package.

simplified schematic & pad description

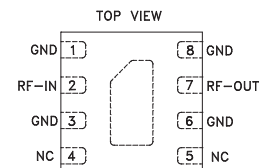
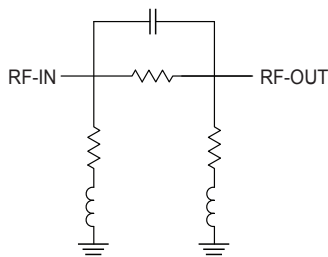

Function	Pad Number	Description
RF-IN	2	RF-Input pad
RF-OUT	7	RF-Output pad
GND	1,3,6,8 & Paddle	Ground
NC	4,5	No connection, connected to ground externally

Electrical Specifications¹ at 25°C, 50Ω, unless otherwise noted.

Parameter	Condition (GHz)	Min.	Typ.	Max.	Units
Frequency Range		DC		20	GHz
Insertion Loss	0.01	10.8	11.1	11.4	dB
	5	—	9.6	—	
	10	—	5.8	—	
	18	1.2	1.4	1.8	
	20	—	0.9	—	
VSWR	0.01 - 5	—	1.11	—	:1
	5 - 10	—	1.18	—	
	10 - 18	—	1.27	—	
	18 - 20	—	1.09	—	

1. Measured on Mini-Circuits Characterization Test Board TB-EQY-10-24+. See Characterization Test Circuit (Fig. 1)

Absolute Maximum Ratings²

Operating Case Temperature	-55°C to 105°C
Storage Temperature	-65°C to 150°C
RF Input Power ³	33 dBm

2. Permanent damage may occur if any of these limits are exceeded.

3. Derates linearly to 31 dBm at 105°C

Characterization Test Circuit

Fig 1. Block Diagram of Test Circuit used for characterization. Test Board TB-EQY-10-24+
Conditions: Attenuation & Return Loss Pin=0 dBm

Product Marking

Marking may contain other features or characters for internal lot control

Typical Performance Data at 25°C

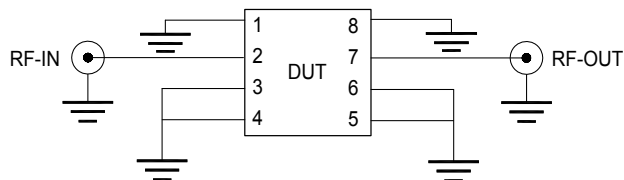
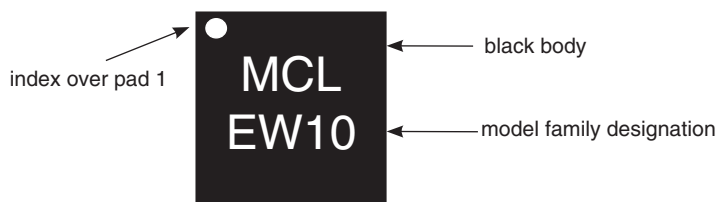
Frequency (MHz)	Insertion Loss (dB)	Input VSWR (:1)	Output VSWR (:1)
10	11.13	1.11	1.11
1000	11.06	1.09	1.09
2000	10.83	1.07	1.07
4000	10.08	1.16	1.18
5000	9.60	1.24	1.27
6000	8.98	1.30	1.33
8000	7.37	1.19	1.20
10000	5.75	1.08	1.10
12000	4.42	1.37	1.37
14000	3.27	1.48	1.50
15000	2.71	1.42	1.45
16000	2.20	1.32	1.35
17000	1.77	1.20	1.21
18000	1.39	1.11	1.09
19000	1.11	1.09	1.09
20000	0.90	1.13	1.13

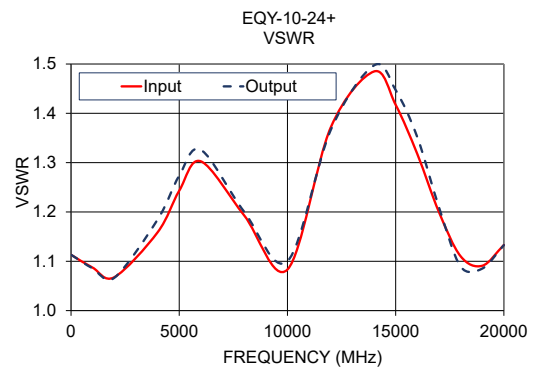
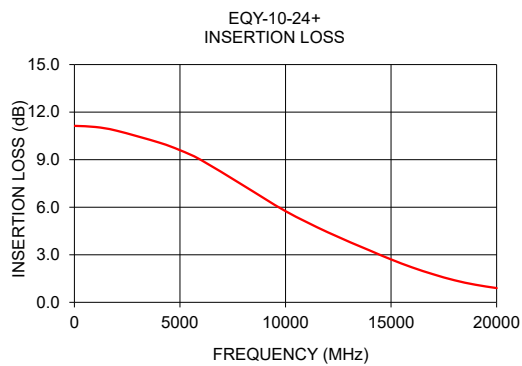

Additional Detailed Technical Information	
<i>additional information is available on our dash board. To access this information click here</i>	
Performance Data	Data Table
	Swept Graphs
Case Style	MC1631-1 <i>Plastic package, Lead finish: Matte-tin</i>
Tape & Reel Standard quantities available on reel	F66 <i>7" reels with 20, 50, 100, 200, 500, 1K or 2K devices</i>
Suggested Layout for PCB Design	PL-618
Evaluation Board	TB-EQY-10-24+
Environmental Ratings	ENV08T1

ESD Rating

Human Body Model (HBM): Class 2 (Pass 2000V) in accordance with ANSI/ESD STM 5.1 - 2001 Machine.

MSL Test Flow Chart

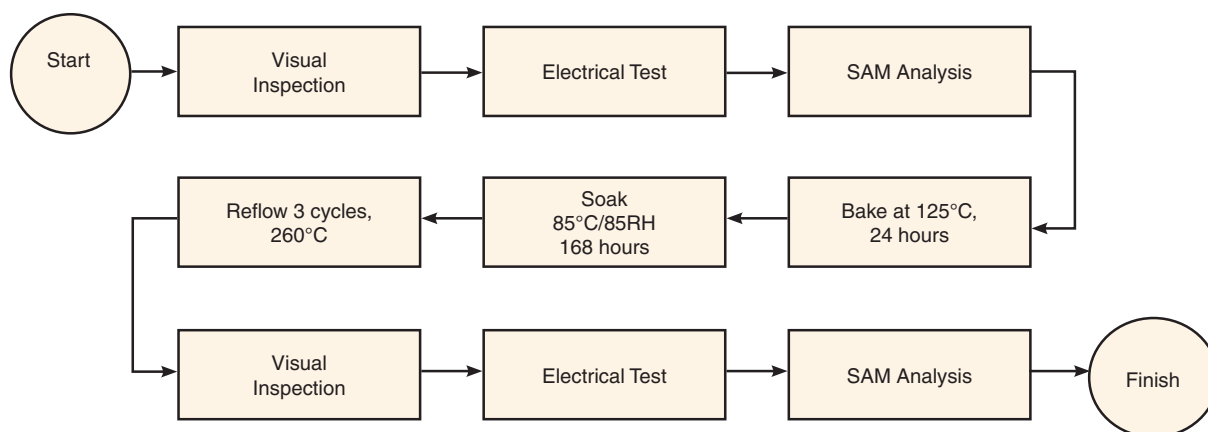

Additional Notes

- Performance and quality attributes and conditions not expressly stated in this specification document are intended to be excluded and do not form a part of this specification document.
- Electrical specifications and performance data contained in this specification document are based on Mini-Circuit's applicable established test performance criteria and measurement instructions.
- The parts covered by this specification document are subject to Mini-Circuits standard limited warranty and terms and conditions (collectively, "Standard Terms"); Purchasers of this part are entitled to the rights and benefits contained therein. For a full statement of the Standard Terms and the exclusive rights and remedies thereunder, please visit Mini-Circuits' website at www.minicircuits.com/MCLStore/terms.jsp

X-ON Electronics

Largest Supplier of Electrical and Electronic Components

Click to view similar products for [Equalisers](#) category:

Click to view products by [Mini-Circuits](#) manufacturer:

Other Similar products are found below :

[M22554G-12](#) [M21424G-13](#) [PTN3944EWY](#) [M21518G-13](#) [EQCO30T5.2](#) [AD8195ACPZ-R7](#) [AD8192ACPZ-RL7](#) [AD8124ACPZ](#)
[AD8128ACPZ-R2](#) [AD8192ACPZ](#) [AD8194ACPZ](#) [AD8195ACPZ](#) [AD8197AASTZ](#) [ADN8102ACPZ](#) [ADV3002BSTZ](#) [ADV3003ACPZ](#)
[ADV3003ACPZ-R7](#) [MAX3814CHJ+T](#) [MAX3802UTK+D](#) [MAX3980UTH+](#) [MAX3815CCM+TD](#) [EQCO30R5.D](#) [MAX3814CHJ+](#) [GS3440-](#)
[INTE3](#) [MAX3984UTE+](#) [GS2964-INE3](#) [GS6042-INE3](#) [GS2974ACNE3](#) [GS2984-INE3](#) [GS3440-INE3](#) [GS2993-INE3](#) [SN75LVPE802RTJT](#)
[NB7VQ1006MMNG](#) [QPC7334SR](#) [QPC7335SR](#) [ISL54102ACQZ](#) [GS12141-INE3](#) [GS12341-INE3](#) [GS3590-INE3](#) [VSC7224XJV-02](#)
[LMH0044SQE/NOPB](#) [LMH0074SQE/NOPB](#) [DS30EA101SQ/NOPB](#) [LMH0344SQE/NOPB](#) [LMH0344SQ/NOPB](#) [LMH0384SQE/NOPB](#)
[LMH0384SQ/NOPB](#) [LMH0394SQ/NOPB](#) [LMH0395SQE/NOPB](#) [LMH0395SQ/NOPB](#)