

Microwave Gain Equalizers

EQY-XX-24+ Series

50Ω DC to 20 GHz



CASE STYLE: MC1631-1

The Big Deal

- Excellent Return Loss, 20dB typ.
- Wide bandwidth, DC - 20 GHz
- Small Size, 2 mm x 2 mm

Product Overview

EQY-XX-24+ Series of absorptive Gain Equalizers are fabricated using highly repetitive GaAs IPD* MMIC process incorporating resistors, capacitors and inductors having negative insertion loss slope. EQYs are available with nominal attenuation slope of 0,2,3,5,6,8,10,12 dB. They are packaged in tiny 2 x 2 mm 8-Lead MCLP™ package.

Key Features

| Feature | Advantages |
|---|--|
| Negative Insertion Loss Slope vs. Frequency | Useful for compensating negative gain slope of amplifiers, receivers, transmitters to achieve flat gain versus frequency. |
| Wide range of values 0,2,3,5,6,8,10,12 dB | Enables circuit designer to change nominal insertion loss values without motherboard redesign making the EQY-XX-24+ Series ideal for select at test application. |
| Wideband operation, DC to 20 GHz | Supports a wide array of applications including wireless cellular, microwave communications, satellite, defense and aerospace, medical broadband and optic applications. |
| Excellent Power Handling Capability | Enables its use at the output of a variety of amplifiers |
| Small Size and simple to use (2 mm x 2 mm) | As a single chip solution, the EQY-XX-24+ Series occupies less board space than a lumped element approach, minimizes component count and ensures repeatable performance over wide frequency range. |

*GaAs IPD (Gallium Arsenide Integrated Passive Device)

Microwave Gain Equalizer

EQY-8-24+

50Ω 8dB DC to 20 GHz

Product Features

- 8.3 dB Slope
- Small Package 2 x 2 mm MCLP
- Wide Bandwidth, DC-20 GHz
- Excellent Return Loss, 20 dB typ.

Typical Applications

- Fixed Satellite
- Mobile
- Radio location
- Space research



Generic photo used for illustration purposes only

CASE STYLE: MC1631-1

+RoHS Compliant

The +Suffix identifies RoHS Compliance. See our web site for RoHS Compliance methodologies and qualifications

General Description

EQY-8-24+ is an absorptive Gain Equalizer fabricated using highly repetitive GaAs IPD MMIC process incorporating resistors, capacitors and inductors having negative insertion loss slope. EQY-8-24+ has a nominal attenuation slope of 8.3 dB and is packaged in tiny 2 x 2 mm, 8-Lead MCLP™ package.

simplified schematic & pad description

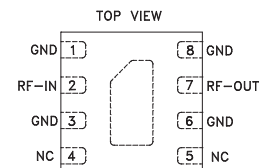
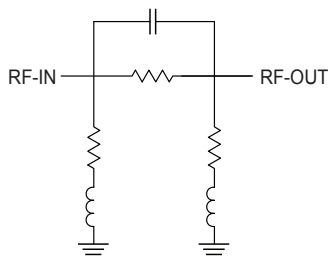

| Function | Pad Number | Description |
|----------|------------------|---|
| RF-IN | 2 | RF-Input pad |
| RF-OUT | 7 | RF-Output pad |
| GND | 1,3,6,8 & Paddle | Ground |
| NC | 4,5 | No connection, connected to ground externally |

Electrical Specifications¹ at 25°C, 50Ω, unless otherwise noted.

| Parameter | Condition (GHz) | Min. | Typ. | Max. | Units |
|-----------------|-----------------|------|------|------|-------|
| Frequency Range | | DC | | 20 | GHz |
| Insertion Loss | 0.01 | 8.8 | 9.1 | 9.4 | dB |
| | 5 | — | 8.0 | — | |
| | 10 | — | 5.2 | — | |
| | 18 | 1.3 | 1.5 | 1.9 | |
| | 20 | — | 0.8 | — | |
| VSWR | 0.01 - 5 | — | 1.06 | — | :1 |
| | 5 - 10 | — | 1.18 | — | |
| | 10 - 18 | — | 1.29 | — | |
| | 18 - 20 | — | 1.10 | — | |

1. Measured on Mini-Circuits Characterization Test Board TB-EQY-8-24+. See Characterization Test Circuit (Fig. 1)

Absolute Maximum Ratings²

| | |
|-----------------------------|----------------|
| Operating Case Temperature | -55°C to 105°C |
| Storage Temperature | -65°C to 150°C |
| RF Input Power ³ | 34 dBm |

2. Permanent damage may occur if any of these limits are exceeded.
 3. Derates linearly to 32 dBm at 105°C

Characterization Test Circuit

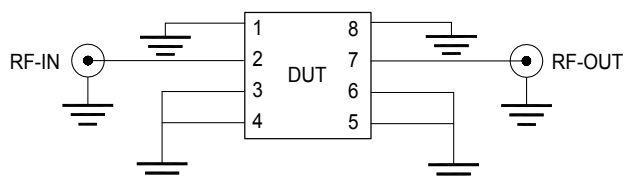
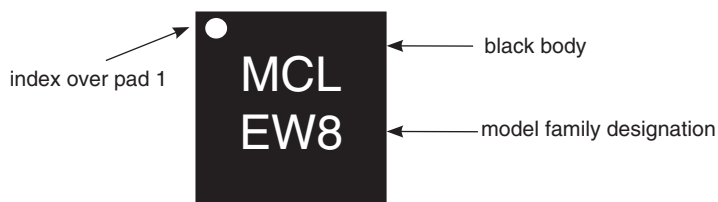

Fig 1. Block Diagram of Test Circuit used for characterization. Test Board TB-EQY-8-24+
Conditions: Attenuation & Return Loss Pin=0 dBm

Product Marking



Marking may contain other features or characters for internal lot control

Typical Performance Data at 25°C

| Frequency (MHz) | Insertion Loss (dB) | Input VSWR (:1) | Output VSWR (:1) |
|-----------------|---------------------|-----------------|------------------|
| 10 | 9.11 | 1.08 | 1.08 |
| 1000 | 9.07 | 1.05 | 1.05 |
| 2000 | 8.91 | 1.03 | 1.03 |
| 4000 | 8.37 | 1.07 | 1.09 |
| 5000 | 8.01 | 1.15 | 1.16 |
| 6000 | 7.58 | 1.22 | 1.23 |
| 8000 | 6.49 | 1.21 | 1.20 |
| 10000 | 5.25 | 1.08 | 1.11 |
| 12000 | 4.23 | 1.33 | 1.34 |
| 14000 | 3.38 | 1.54 | 1.52 |
| 15000 | 2.92 | 1.54 | 1.52 |
| 16000 | 2.42 | 1.44 | 1.43 |
| 17000 | 1.92 | 1.28 | 1.26 |
| 18000 | 1.47 | 1.14 | 1.12 |
| 19000 | 1.12 | 1.09 | 1.11 |
| 20000 | 0.86 | 1.13 | 1.15 |

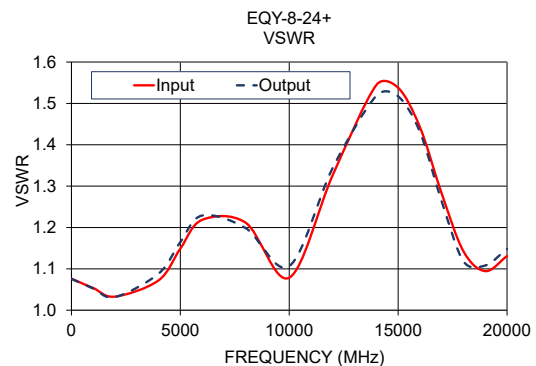
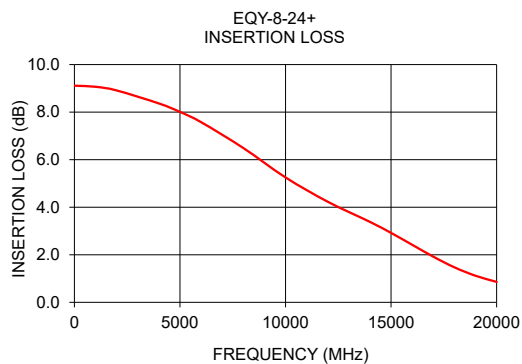

| Additional Detailed Technical Information | |
|---|---|
| <i>additional information is available on our dash board. To access this information click here</i> | |
| Performance Data | Data Table |
| | Swept Graphs |
| Case Style | MC1631-1 <i>Plastic package, Lead finish: Matte-tin</i> |
| Tape & Reel Standard quantities available on reel | F66 <i>7" reels with 20, 50, 100, 200, 500, 1K or 2K devices</i> |
| Suggested Layout for PCB Design | PL-618 |
| Evaluation Board | TB-EQY-8-24+ |
| Environmental Ratings | ENV08T1 |

ESD Rating

Human Body Model (HBM): Class 2 (Pass 2000V) in accordance with ANSI/ESD STM 5.1 - 2001 Machine.

MSL Test Flow Chart

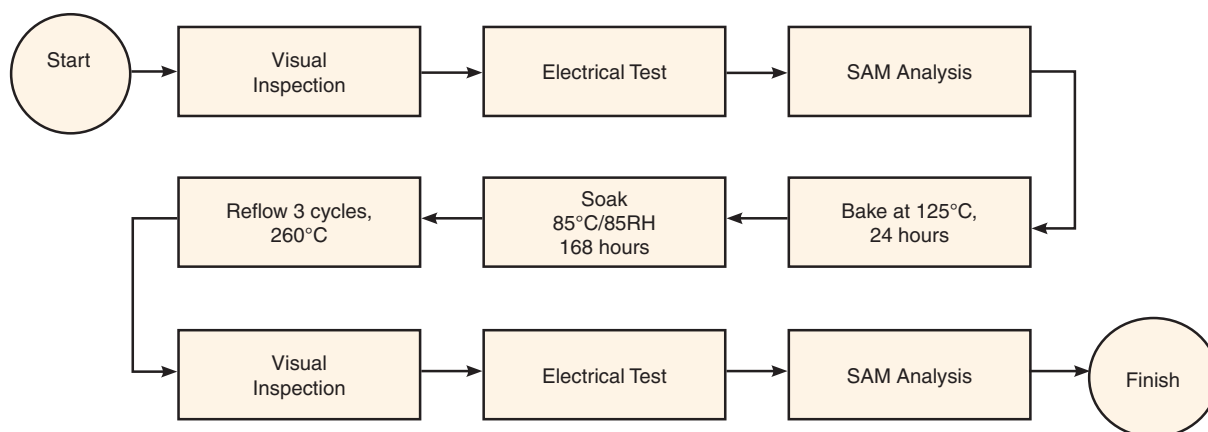

Additional Notes

- Performance and quality attributes and conditions not expressly stated in this specification document are intended to be excluded and do not form a part of this specification document.
- Electrical specifications and performance data contained in this specification document are based on Mini-Circuit's applicable established test performance criteria and measurement instructions.
- The parts covered by this specification document are subject to Mini-Circuits standard limited warranty and terms and conditions (collectively, "Standard Terms"); Purchasers of this part are entitled to the rights and benefits contained therein. For a full statement of the Standard Terms and the exclusive rights and remedies thereunder, please visit Mini-Circuits' website at www.minicircuits.com/MCLStore/terms.jsp

X-ON Electronics

Largest Supplier of Electrical and Electronic Components

Click to view similar products for [Equalisers](#) category:

Click to view products by [Mini-Circuits](#) manufacturer:

Other Similar products are found below :

[M22554G-12](#) [M21424G-13](#) [PTN3944EWY](#) [M21518G-13](#) [EQCO30T5.2](#) [AD8195ACPZ-R7](#) [AD8192ACPZ-RL7](#) [AD8124ACPZ](#)
[AD8128ACPZ-R2](#) [AD8192ACPZ](#) [AD8194ACPZ](#) [AD8195ACPZ](#) [AD8197AASTZ](#) [ADN8102ACPZ](#) [ADV3002BSTZ](#) [ADV3003ACPZ](#)
[ADV3003ACPZ-R7](#) [MAX3814CHJ+T](#) [MAX3802UTK+D](#) [MAX3980UTH+](#) [MAX3815CCM+TD](#) [EQCO30R5.D](#) [MAX3814CHJ+](#) [GS3440-](#)
[INTE3](#) [MAX3984UTE+](#) [GS2964-INE3](#) [GS6042-INE3](#) [GS2974ACNE3](#) [GS2984-INE3](#) [GS3440-INE3](#) [GS2993-INE3](#) [SN75LVPE802RTJT](#)
[NB7VQ1006MMNG](#) [QPC7334SR](#) [QPC7335SR](#) [ISL54102ACQZ](#) [GS12141-INE3](#) [GS12341-INE3](#) [GS3590-INE3](#) [VSC7224XJV-02](#)
[LMH0044SQE/NOPB](#) [LMH0074SQE/NOPB](#) [DS30EA101SQ/NOPB](#) [LMH0344SQE/NOPB](#) [LMH0344SQ/NOPB](#) [LMH0384SQE/NOPB](#)
[LMH0384SQ/NOPB](#) [LMH0394SQ/NOPB](#) [LMH0395SQE/NOPB](#) [LMH0395SQ/NOPB](#)