

Ceramic

Low Pass Filter

LFCW-1142+

50Ω

DC to 11.4 GHz

The Big Deal

- Small size 0603 (1.6 x 0.8 mm)
- Low insertion loss, 2.2 dB typical
- Rejection 20 dB typical from 12.7 to 16.8 GHz
- Good power handling, 6.3W



CASE STYLE: JC0603C-1

Product Overview

Mini-Circuits' LFCW-1142+ is a Low Temperature Co-fired Ceramic (LTCC) low pass filter, designed in a very small, 0603 package. The multilayer construction provides high repeatability of performance. Small, wrap-around terminations minimize variations in performance due to parasitics. Covering DC – 11.4 GHz, these units offer low insertion loss, good rejection, and excellent power handling capability.

Key Features

Feature	Advantages
Small size 0603 (1.6 x 0.8 mm)	Allows for high layout density of circuit boards while minimizing the effects of parasitics.
Stop band rejection 20 dB typical over 12.7 –16.8 GHz	Provides good rejection in a tiny package, saving PCB space for customers.
Wrap-around terminations	Provides excellent solderability and easy visual inspection.
LTCC construction	Rugged package, well-suited for tough environments including high humidity and high temperature extremes.

Notes

- A. Performance and quality attributes and conditions not expressly stated in this specification document are intended to be excluded and do not form a part of this specification document.
B. Electrical specifications and performance data contained in this specification document are based on Mini-Circuit's applicable established test performance criteria and measurement instructions.
C. The parts covered by this specification document are subject to Mini-Circuits standard limited warranty and terms and conditions (collectively, "Standard Terms"); Purchasers of this part are entitled to the rights and benefits contained therein. For a full statement of the Standard Terms and the exclusive rights and remedies thereunder, please visit Mini-Circuits' website at www.minicircuits.com/MCLStore/terms.jsp



Ceramic Low Pass Filter

LFCW-1142+

50Ω DC¹ to 11.4 GHz



Generic photo used for illustration purposes only

CASE STYLE: JC0603C-1

Features

- Good power handling, 6.3W
- Small size 0603 (1.6 x 0.8 mm)
- 7 sections
- Temperature stable
- LTCC construction

+RoHS Compliant

The +Suffix identifies RoHS Compliance. See our web site for RoHS Compliance methodologies and qualifications

Applications

- Harmonic Rejection
- VHF/UHF transmitters / receivers
- lab use

Electrical Specifications^{1,2} at 25°C

Parameter	F#	Frequency (GHz)	Min.	Typ.	Max.	Unit
Pass Band	Insertion Loss	DC - F1	DC - 11.4	—	2.6	dB
	Freq. cut-off	F2	11.7	3.0	—	dB
	VSWR	DC - F1	DC - 11.4	—	1.85	:1
Stop Band	Rejection Loss	F3	12.7	—	20	dB
		F4 - F5	12.86 - 13.86	23	28.5	:1
		F6	16.8	—	20	dB
		F7	20.0	—	20	dB

1. In Application where DC voltage is present at either input or output port, coupling capacitors are required.
2. Measured on Mini-Circuits Characterization Test Board TB-720+

Functional Schematic

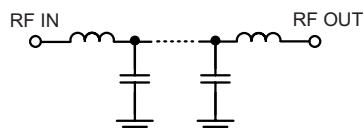

Maximum Ratings

Operating Temperature	-55°C to 100°C
Storage Temperature	-55°C to 100°C
RF Power Input ³	6.3W at 25°C

3. Passband rating, derate linearly to 3.2W at 100°C ambient ([Reference AN-75-005](#))
- Permanent damage may occur if any of these limits are exceeded.

Typical Frequency Response

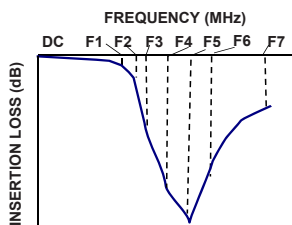

Typical Performance Data at 25°C

Frequency (MHz)	Insertion Loss (dB)	VSWR (:1)
0.01	0.02	1.02
0.50	0.13	1.06
1.00	0.17	1.12
3.00	0.33	1.30
5.00	0.39	1.23
7.00	0.44	1.09
9.00	0.66	1.15
10.00	0.95	1.34
11.40	1.90	1.49
11.70	2.49	1.57
12.70	25.16	8.57
12.86	36.87	10.65
13.86	42.42	21.84
15.21	35.60	36.45
16.80	23.97	38.76
18.00	19.40	34.10
20.00	15.10	27.70

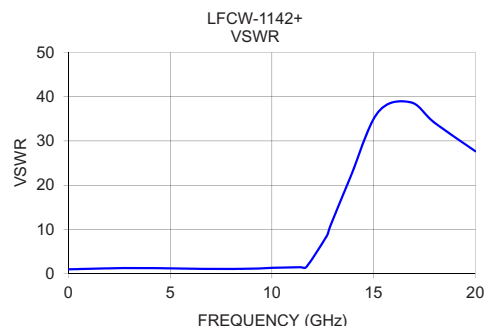
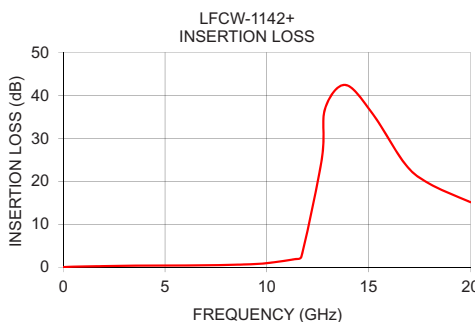

Notes

- Performance and quality attributes and conditions not expressly stated in this specification document are intended to be excluded and do not form a part of this specification document.
- Electrical specifications and performance data contained in this specification document are based on Mini-Circuit's applicable established test performance criteria and measurement instructions.
- The parts covered by this specification document are subject to Mini-Circuits standard limited warranty and terms and conditions (collectively, "Standard Terms"); Purchasers of this part are entitled to the rights and benefits contained therein. For a full statement of the Standard Terms and the exclusive rights and remedies thereunder, please visit Mini-Circuits' website at www.minicircuits.com/MCLStore/terms.jsp



www.minicircuits.com P.O. Box 350166, Brooklyn, NY 11235-0003 (718) 934-4500 sales@minicircuits.com

REV. B
M151107
ED-15030/1
LFCW-1142+
MY/CP/AM
201201
Page 2 of 3

Pad Connections

INPUT	1
OUTPUT	3
GROUND	2,4

Product Marking: N/A

Evaluation Board MCL P/N: TB-LFCW-1142+
Suggested PCB Layout (PL-412)

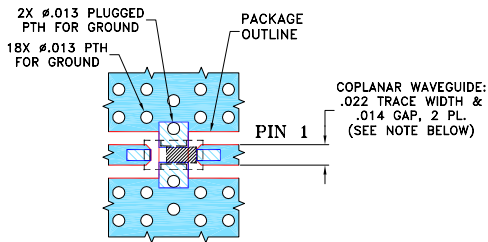

NOTES:

- TRACE WIDTH IS SHOWN FOR ROGERS R04350B WITH DIELECTRIC THICKNESS .010" ± .001"; COPPER: 1/2 OZ. EACH SIDE. FOR OTHER MATERIALS TRACE WIDTH AND GAP MAY NEED TO BE MODIFIED.
- BOTTOM SIDE OF THE PCB IS CONTINUOUS GROUND PLANE.

 DENOTES PCB COPPER LAYOUT WITH SMOBC (SOLDER MASK OVER BARE COPPER).

 DENOTES COPPER LAND PATTERN FREE OF SOLDER MASK.

Outline Drawing

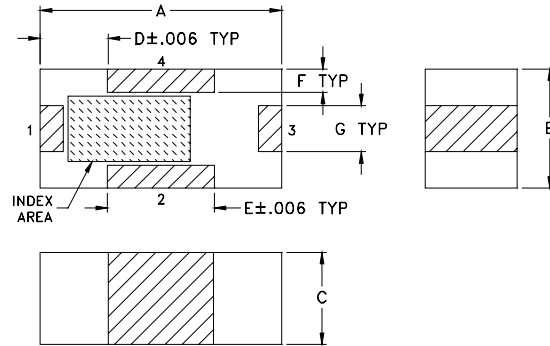

Outline Dimensions (inch/mm)

A	B	C	D	E	F	G	wt
.063	.031	.024	.018	.028	.006	.012	grams
1.60	0.79	0.61	0.46	0.71	0.15	0.30	0.005

Notes

- Performance and quality attributes and conditions not expressly stated in this specification document are intended to be excluded and do not form a part of this specification document.
- Electrical specifications and performance data contained in this specification document are based on Mini-Circuit's applicable established test performance criteria and measurement instructions.
- The parts covered by this specification document are subject to Mini-Circuits standard limited warranty and terms and conditions (collectively, "Standard Terms"); Purchasers of this part are entitled to the rights and benefits contained therein. For a full statement of the Standard Terms and the exclusive rights and remedies thereunder, please visit Mini-Circuits' website at www.minicircuits.com/MCLStore/terms.jsp

X-ON Electronics

Largest Supplier of Electrical and Electronic Components

Click to view similar products for [Signal Conditioning](#) category:

Click to view products by [Mini-Circuits](#) manufacturer:

Other Similar products are found below :

[MAPDCC0001](#) [MAPDCC0004](#) [PD0409J5050S2HF](#) [880157](#) [HHS-109-PIN](#) [DC1417J5005AHF](#) [AFS14A30-2185.00-T3](#) [AFS14A35-1591.50-T3](#) [DS-323-PIN](#) [B39321R801H210](#) [1A0220-3](#) [JP510S](#) [LFB212G45SG8C341](#) [LFB322G45SN1A504](#) [LFL182G45TC3B746](#) [SF2159E](#) [30057](#)
[FM-104-PIN](#) [CER0813B](#) [MAPDCC0005](#) [3A325](#) [40287](#) [41180](#) [ATB3225-75032NCT](#) [BD0810N50100AHF](#) [BD2425J50200AHF](#)
[C5060J5003AHF](#) [JHS-115-PIN](#) [JP503AS](#) [DC0710J5005AHF](#) [DC2327J5005AHF](#) [DC3338J5005AHF](#) [43020](#) [LFB2H2G60BB1C106](#)
[LFL15869MTC1B787](#) [X3C19F1-20S](#) [XC3500P-20S](#) [10013-20](#) [SF2194E](#) [CDBLB455KCAX39-B0](#) [TGL2208-SM, EVAL](#) [RF1353C](#)
[PD0922J5050D2HF](#) [1E1305-3](#) [1G1304-30](#) [B0922J7575AHF](#) [2020-6622-20](#) [TP-102-PIN](#) [TP-103-PIN](#) [BD1222J50200AHF](#)