

Ultra High Dynamic Range Monolithic Amplifier

LHA-23LN+

50Ω 30MHz to 2 GHz

The Big Deal

- Ultra-High IP3, +36.9 dBm typ.
- Low supply voltage, 3 to 5V
- Excellent Noise Figure, 1.2 dB typ.

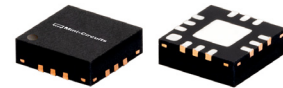

CASE STYLE: DQ1225

Product Overview

LHA-23LN+ (RoHS compliant) is an advanced wideband amplifier fabricated using E-PHEMT technology and offers extremely high dynamic range over a broad frequency range and with low noise figure. In addition, the LHA-23LN+ has good input and output return loss over a broad frequency range. LHA-23LN+ is enclosed in a 3mm x 3mm, 12-lead MCLP package and has very good thermal performance.

Key Features

Feature	Advantages
Broad Band: 30MHz to 2GHz	Broadband covering primary wireless communications bands: VHF, UHF, Cellular
Extremely High IP3 40.3 dBm typical at 0.5 GHz 36.9 dBm typical at 1GHz	The LHA-23LN+ matches industry leading IP3 performance relative to device size and power consumption. The combination of the design and E-PHEMT Structure provides enhanced linearity over a broad frequency range as evidence in the IP3 being approximately 11-17 dB above the P1dB point. This feature makes this amplifier ideal for use in: <ul style="list-style-type: none">• Driver amplifiers for complex waveform up converter paths• Drivers in linearized transmit systems• Secondary amplifiers in ultra-High Dynamic range receivers
Low Noise Figure 1.2 dB at 1 GHz	Enables lower system noise figure performance and along with High OIP3 provides high dynamic range
Low Supply Voltage	LHA-23LN+ supports low supply voltage operation which indicate low power consumption.



Ultra High Dynamic Range Monolithic Amplifier

30MHz to 2 GHz

Product Features

- High IP3, 36.9 dBm typ. at 1GHz
- Gain, 21.2 dB typ. at 1 GHz
- Low noise figure, 1.2 dB at 1 GHz
- Low voltage, 5V and 3V

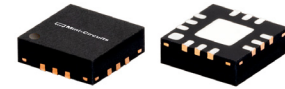

Generic photo used for illustration purposes only

LHA-23LN+

CASE STYLE: DQ1225

Typical Applications

- Base station infrastructure
- CATV
- Cellular

+RoHS Compliant

The +Suffix identifies RoHS Compliance. See our web site for RoHS Compliance methodologies and qualifications

General Description

LHA-23LN+ (RoHS compliant) is an advanced wideband amplifier fabricated using E-PHEMT technology and offers extremely high dynamic range over a broad frequency range and with low noise figure. In addition, the LHA-23LN+ has good input and output return loss over a broad frequency range. LHA-23LN+ is enclosed in a 3mm x 3mm, 12-lead MCLP package and has very good thermal performance.

simplified schematic and pad description

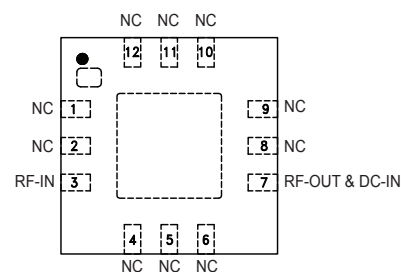
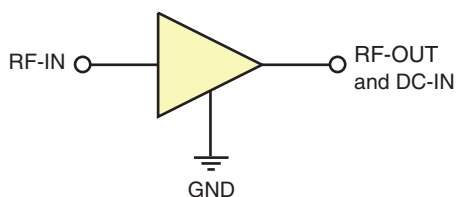

Function	Pin Number	Description
RF IN	3	RF Input
RF-OUT and DC-IN	7	RF Output and DC Bias
GND	Paddle	Connections to ground.
NC	1-2, 4-6, 8-12	No connection, grounded externally

Electrical Specifications¹ at 25°C, 50Ω, unless noted

Parameter	Condition (GHz)	Vd=5V ¹			Vd=3V ¹	Units
		Min.	Typ.	Max.	Typ.	
Frequency Range		30		2000	30-2000	MHz
Gain	30	—	23.0	—	22.3	dB
	500	—	21.9	—	21.1	
	1000	18.9	21.2	23.1	19.9	
	1500	18.1	20.4	22.1	18.8	
	2000	—	19.6	—	17.6	
Input Return Loss	30		12		12	dB
	500		11		11	
	1000		10		8	
	1500		10		7	
	2000		10		8	
Output Return Loss	30		14		16	dB
	500		15		18	
	1000		19		23	
	1500		15		13	
	2000		11		9	
Reverse isolation	1000		26.9		26.6	dB
Output Power @1 dB compression	30		22.8		17.1	dBm
	500		24.2		19.2	
	1000		23.8		18.8	
	1500		23.2		18.4	
	2000		23.0		18.0	
Output IP ₃ ²	30		39.8		33.9	dBm
	500		39.0		33.5	
	1000		36.9		31.6	
	1500		35.2		30.7	
	2000		34.6		30.0	
Noise Figure	30		1.0		1.0	dB
	500		1.1		1.1	
	1000		1.2		1.2	
	1500		1.3		1.3	
	2000		1.5		1.6	
Device Operating Voltage			5.0		3.0	V
Device Operating Current			146	162	75	mA
Device Current Variation vs. Temperature ³			-26.1		17.5	μA/°C
Device Current Variation vs Voltage			0.0359		0.0364	mA/mV
Thermal Resistance, junction-to-ground lead			23.3		23.3	°C/W
Junction-to-ground lead at 85°C stage temperature						

1. Measured on Mini-Circuits Characterization test board TB-1061-23LN+. See Characterization Test Circuit (Fig. 1)
 2. Tested at P_{out}= 0 dBm / tone.
 3. (Current at 105°C — Current at -45°C)/150

Absolute Maximum Ratings⁴

Parameter	Ratings
Operating Temperature (ground lead)	-40°C to 105°C
Storage Temperature	-65°C to 150°C
Power Dissipation ⁵	3.3W
Input Power (CW)	+22 dBm (5 minutes max) ⁶ +4 dBm (continuous) for 0.03-1GHz at 3V +8 dBm (continuous) for 0.03-1GHz at 5V +12 dBm (continuous) for 1-2GHz at 3V +15 dBm (continuous) for 1-2GHz at 5V
DC Voltage on Pin 7	10V

4. Permanent damage may occur if any of these limits are exceeded.
 Electrical maximum ratings are not intended for continuous normal operation.
 5. Up to 85°C, derate linearly to 2.5W at 105°C.
 6. Up to 85°C, derate linearly to +19dBm at 105°C.

Characterization Test / Recommended Application Circuit

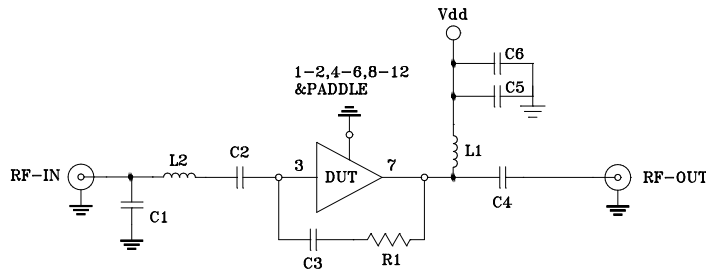

Component	Size	Value	Manufacturer	P/N	
C1	0402	1.2pF	Murata	GRM1555C1H1R2WA01D	
C2,C3,C6		0.1nF		GRM155R71C104KABED	
C4		0.001nF		GRM1555C1H102JA01D	
C5		0.01nF		GRM155R71E103KA01D	
R1		1.21KOhm		KOA	RK73H1ETP1211F
L1		0805		0.68nH	Coolcraft
L2	0402	1nH		0402CS-1N0XJLW	

Fig 1. Block Diagram of Test Circuit used for characterization. (DUT soldered on Mini-Circuits Characterization test board TB-1061-23LN+) Gain, Return loss, Output power at 1dB compression (P1 dB), output IP3 (OIP3) and noise figure measured using Agilent's N5242A PNA-X microwave network analyzer.

Conditions:

1. Gain and Return loss: Pin= -25dBm
2. Output IP3 (OIP3): Two tones, spaced 1 MHz apart, 0 dBm/ tone at output.

Product Marking

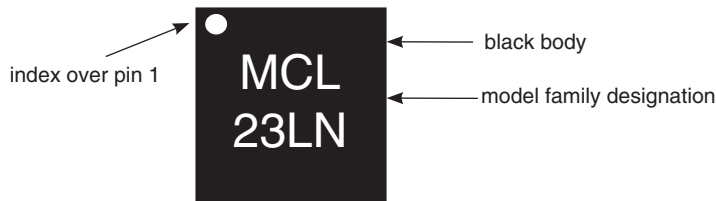

Marking may contain other features or characters for internal lot control

Additional Detailed Technical Information	
<i>additional information is available on our dash board. To access this information click here</i>	
Performance Data	Data Table
	Swept Graphs
	S-Parameter (S2P Files) Data Set (.zip file)
Case Style	DQ1225 <i>Plastic package, exposed paddle lead finish: Matte-Tin</i>
Tape & Reel Standard quantities available on reel	F66 <i>7" reels with 20, 50, 100, 200, 500 or 1K devices</i>
Suggested Layout for PCB Design	PL-587
Evaluation Board	TB-1061-23LN+
Environmental Ratings	ENV08T9

ESD Rating

Human Body Model (HBM): Class 1B (Pass 500 V) in accordance with ANSI/ESD STM 5.1 - 2001

MSL Rating

Moisture Sensitivity: MSL1 in accordance with IPC/JEDEC J-STD-020D

MSL Test Flow Chart

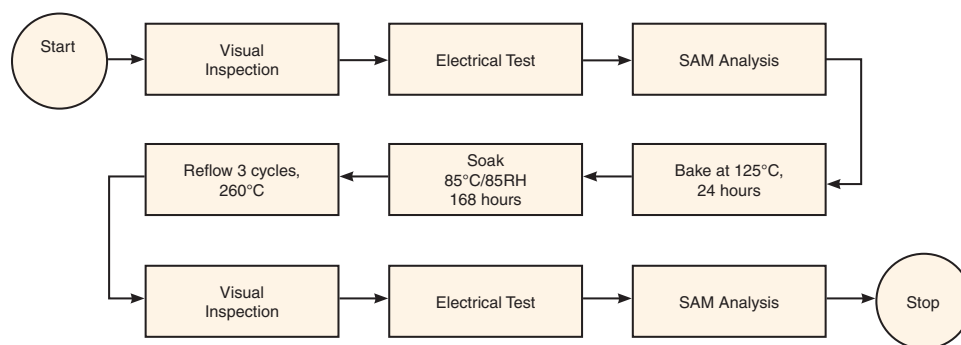

Additional Notes

- A. Performance and quality attributes and conditions not expressly stated in this specification document are intended to be excluded and do not form a part of this specification document.
- B. Electrical specifications and performance data contained in this specification document are based on Mini-Circuit's applicable established test performance criteria and measurement instructions.
- C. The parts covered by this specification document are subject to Mini-Circuits standard limited warranty and terms and conditions (collectively, "Standard Terms"); Purchasers of this part are entitled to the rights and benefits contained therein. For a full statement of the Standard Terms and the exclusive rights and remedies thereunder, please visit Mini-Circuits' website at www.minicircuits.com/MCLStore/terms.jsp

X-ON Electronics

Largest Supplier of Electrical and Electronic Components

Click to view similar products for [RF Amplifier](#) category:

Click to view products by [Mini-Circuits](#) manufacturer:

Other Similar products are found below :

[A82-1](#) [BGA622H6820XTSA1](#) [BGA 728L7 E6327](#) [BGB719N7ESDE6327XTMA1](#) [HMC397-SX](#) [HMC405](#) [HMC561-SX](#) [HMC8120-SX](#)
[HMC8121-SX](#) [HMC-ALH382-SX](#) [HMC-ALH476-SX](#) [SE2433T-R](#) [SMA3101-TL-E](#) [SMA39](#) [A66-1](#) [A66-3](#) [A67-1](#) [LX5535LQ](#) [LX5540LL](#)
[MAAM02350](#) [HMC3653LP3BETR](#) [HMC549MS8GETR](#) [HMC-ALH435-SX](#) [SMA101](#) [SMA32](#) [SMA411](#) [SMA531](#) [SST12LP17E-XX8E](#)
[SST12LP19E-QX6E](#) [WPM0510A](#) [HMC5929LS6TR](#) [HMC5879LS7TR](#) [HMC1126](#) [HMC1087F10](#) [HMC1086](#) [HMC1016](#) [SMA1212](#)
[MAX2689EWS+T](#) [MACS-007802-0M1RS0](#) [MAAMSS0041TR](#) [MAAM37000-A1G](#) [CHA5115-QDG](#) [SMA70-2](#) [SMA4011](#) [A231](#) [HMC-](#)
[AUH232](#) [LX5511LQ](#) [LX5511LQ-TR](#) [HMC7441-SX](#) [HMC-ALH310](#)