

100V N-Channel Power MOSFET

DESCRIPTION

The IRF530 uses advanced trench technology to provide excellent $R_{DS(ON)}$, low gate charge. It can be used in a wide variety of applications.

Application

- Power switching application
- Hard switched and High frequency circuits
- Uninterruptible power supply

KEY CHARACTERISTICS

- $V_{DS} = 100V, I_D = 15A$
 $R_{DS(ON)} < 90m\Omega @ V_{GS}=10V$
 $R_{DS(ON)} < 115m\Omega @ V_{GS}=4.5V$
- High density cell design for lower R_{dson}
- Fully characterized avalanche voltage and current
- Good stability and uniformity with high EAS
- Excellent package for good heat dissipation

100% UIS TESTED!
100% DVDS TESTED!



TO-220

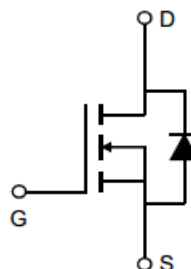

Schematic diagram

Package Marking And Ordering Information

Device Marking	Ordering Codes	Package	Product Code	Packing
IRF530	IRF530	TO-220	IRF530	Tube

Absolute Maximum Ratings ($T_A=25^\circ C$ unless otherwise noted)

Parameter	Symbol	Limit	Unit
Drain-Source Voltage	V_{DS}	100	V
Gate-Source Voltage	V_{GS}	± 20	V
Drain Current-Continuous	I_D	15	A
Drain Current-Pulsed (Note 1)	I_{DM}	40	A
Maximum Power Dissipation($T_c=25^\circ C$)	P_D	31	W
Single pulse avalanche energy (Note 2)	E_{AS}	21	mJ
Operating Junction and Storage Temperature Range	T_J, T_{STG}	-55 To 175	$^\circ C$

Thermal Characteristic

Thermal Resistance, Junction-to-Case	$R_{\theta JC}$	4.8	$^\circ C/W$
--------------------------------------	-----------------	-----	--------------

Electrical Characteristics (TA=25°C unless otherwise noted)

Parameter	Symbol	Condition	Min	Typ	Max	Unit
Off Characteristics						
Drain-Source Breakdown Voltage	BV_{DSS}	$V_{GS}=0V, I_D=250\mu A$	100	-	-	V
Zero Gate Voltage Drain Current	I_{DSS}	$V_{DS}=100V, V_{GS}=0V$	-	-	1	μA
Gate-Body Leakage Current	I_{GSS}	$V_{GS}=\pm 20V, V_{DS}=0V$	-	-	± 100	nA
On Characteristics						
Gate Threshold Voltage	$V_{GS(th)}$	$V_{DS}=V_{GS}, I_D=250\mu A$	1	1.8	2.4	V
Drain-Source On-State Resistance ^(Note 3)	$R_{DS(ON)}$	$V_{GS}=10V, I_D=5A$	-	80	90	m Ω
		$V_{GS}=4.5V, I_D=5A$	-	90	115	
Forward Transconductance	g_{FS}	$V_{DS}=25V, I_D=3.6A$	-	5	-	S
Dynamic Characteristics						
Input Capacitance	C_{iss}	$V_{DS}=25V, V_{GS}=0V,$ $f=1.0MHz$	-	680	-	pF
Output Capacitance	C_{oss}		-	110	-	pF
Reverse Transfer Capacitance	C_{rss}		-	85	-	pF
Switching Characteristics ^(Note 4)						
Turn-on Delay Time	$t_{d(on)}$	$V_{DD}=50V, I_D=5A,$ $V_{GS}=10V, R_{GEN}=2.5\Omega$	-	10	-	nS
Turn-on Rise Time	t_r		-	7	-	nS
Turn-Off Delay Time	$t_{d(off)}$		-	34	-	nS
Turn-Off Fall Time	t_f		-	9	-	nS
Total Gate Charge	Q_g	$V_{DS}=80V, I_D=3A$ $V_{GS}=10V$	-	16	-	nC
Gate-Source Charge	Q_{gs}		-	4	-	nC
Gate-Drain Charge	Q_{gd}		-	5	-	nC
Drain-Source Diode Characteristics						
Diode Forward Voltage	V_{SD}	$V_{GS}=0V, I_S=15A$	-	-	1.2	V

Notes:

1. Repetitive Rating: Pulse width limited by maximum junction temperature.
2. E_{AS} condition : $T_j=25^\circ C, V_{DD}=50V, V_{GS}=10V, L=0.5mH, R_g=25\Omega$
3. Pulse Test: Pulse Width $\leq 300\mu s$, Duty Cycle $\leq 2\%$.
4. Guaranteed by design, not subject to production.

Characteristics Curves

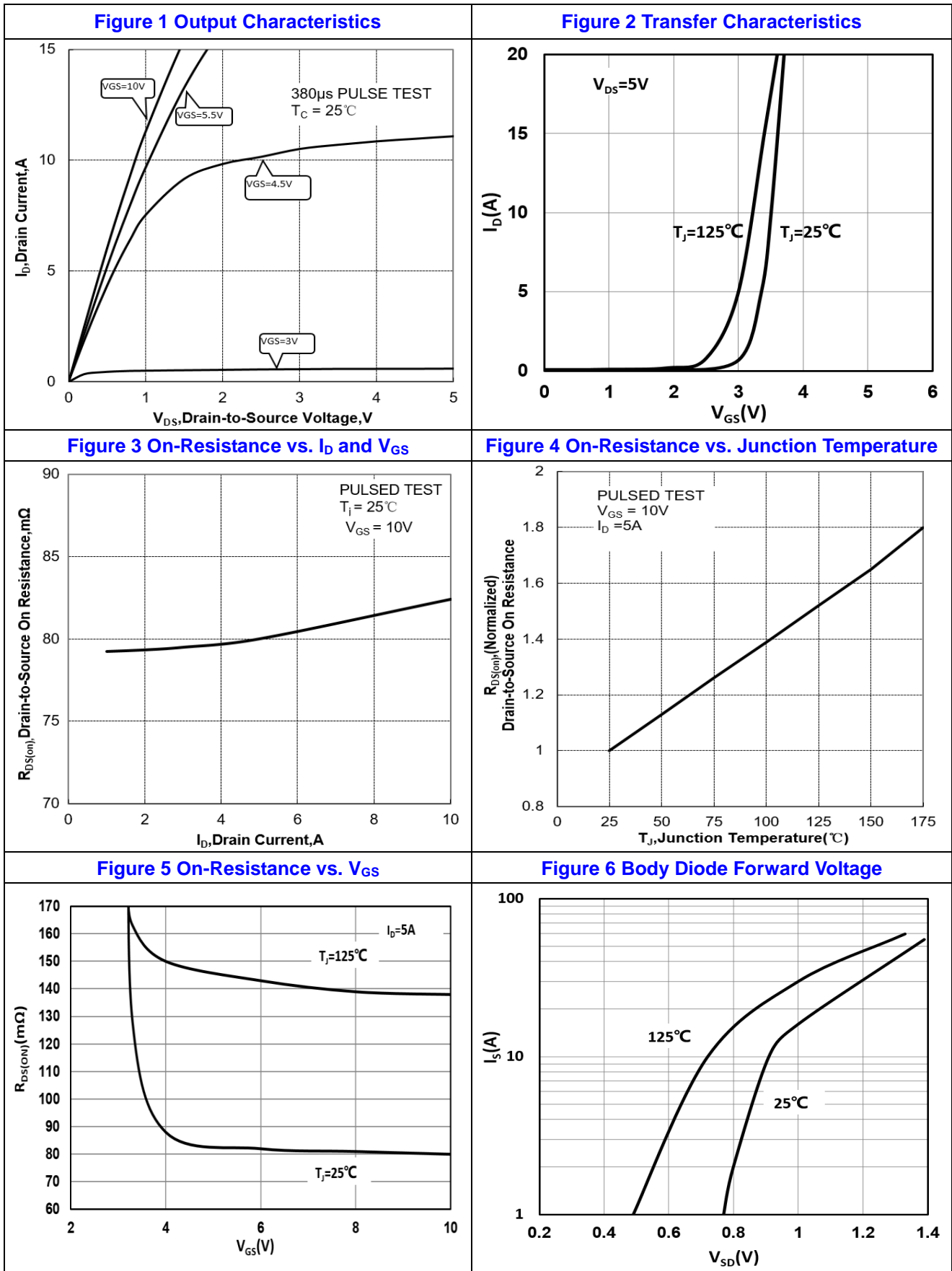

Figure 7 Gate-Charge Characteristics

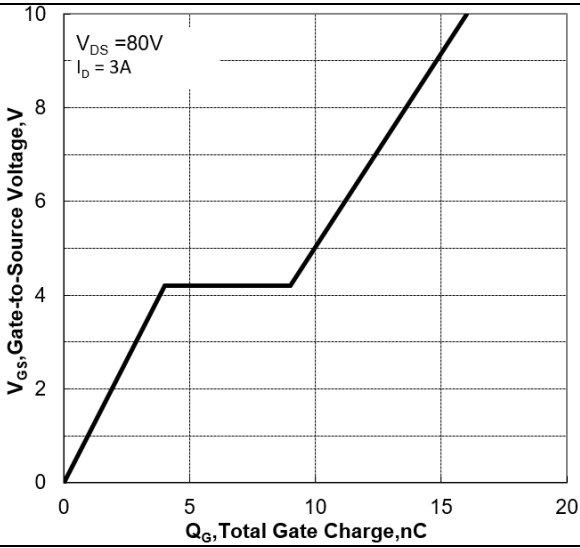

Figure 8 Capacitance Characteristics

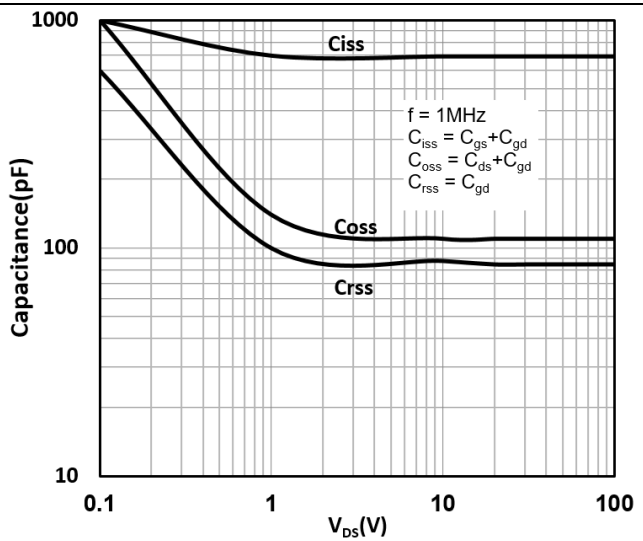

Figure 9 Maximum Forward Biased Safe Operation Area

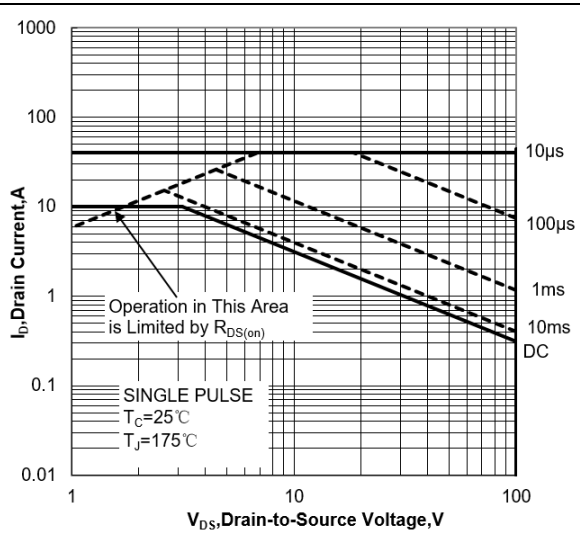

Figure 10 Single Pulse Power Rating Junction-to-Ambient

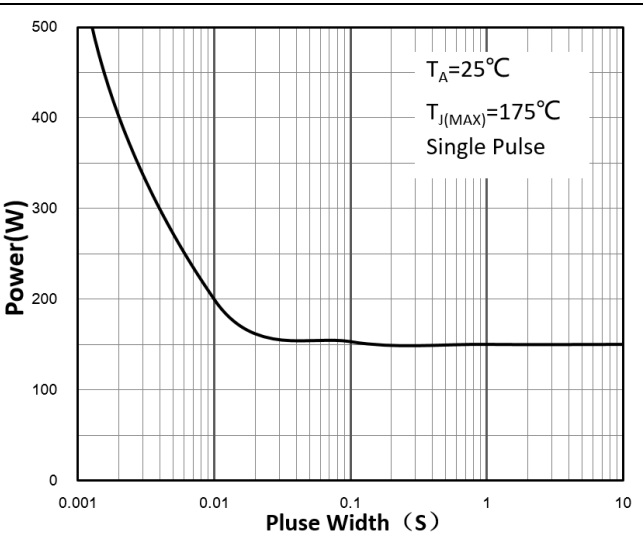
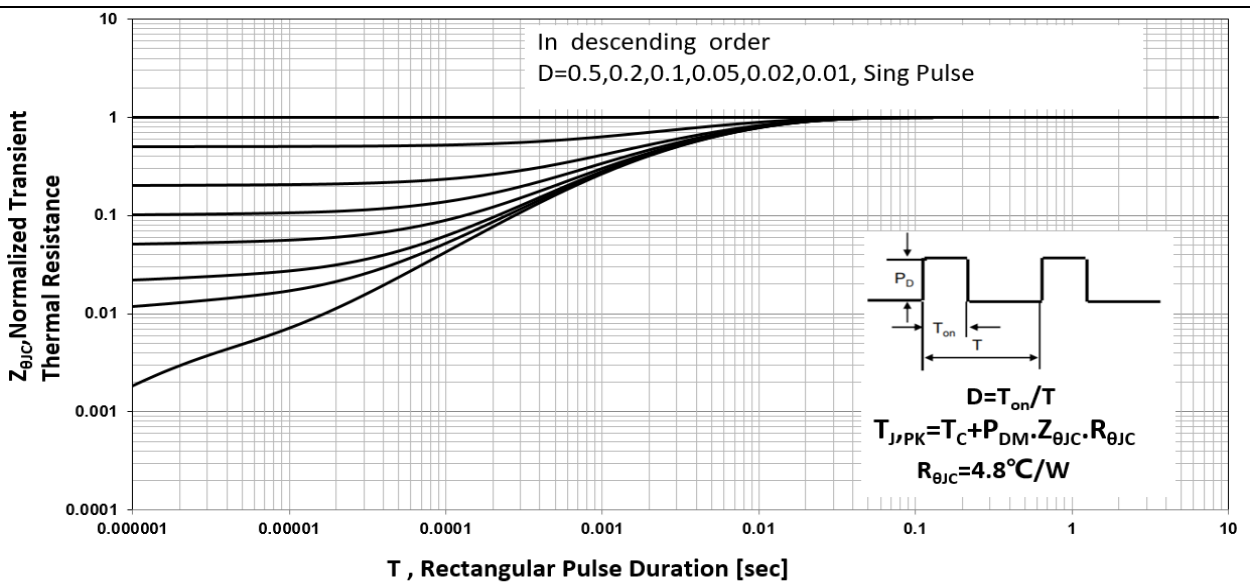
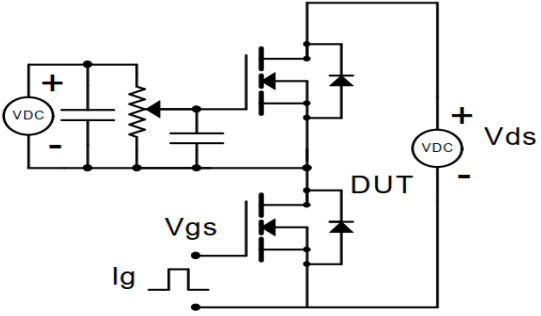
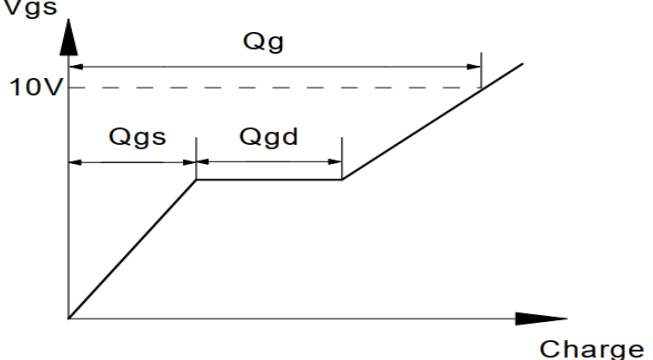
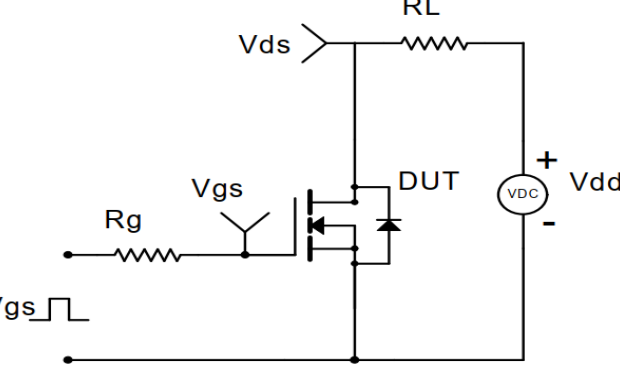
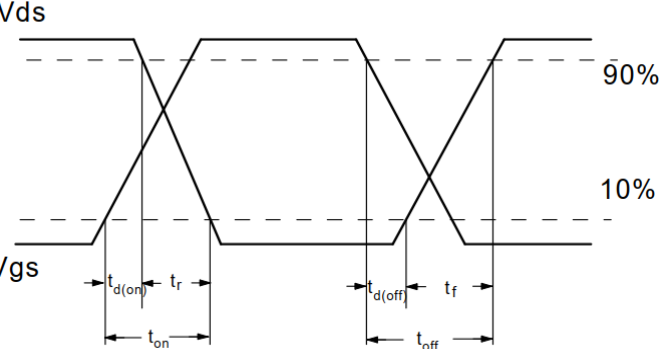
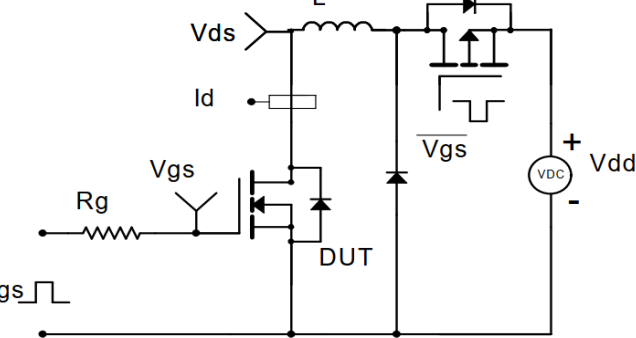
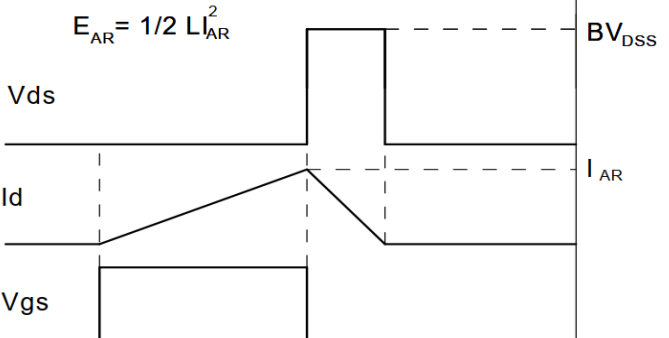
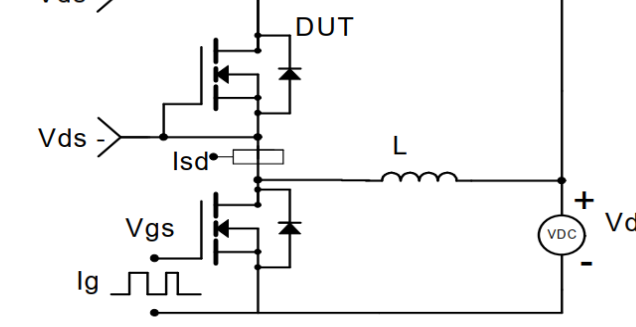
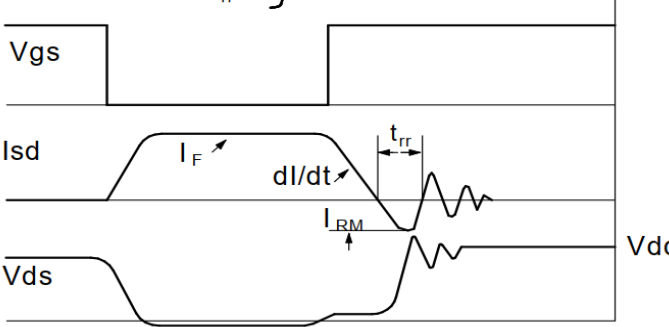

Figure 11 Normalized Maximum Transient Thermal Impedance



Test Circuit and Waveform

<p style="text-align: center;">Gate Charge Test Circuit</p> 	<p style="text-align: center;">Gate Charge Test Waveform</p> 
<p style="text-align: center;">Resistive Switching Test Circuit</p> 	<p style="text-align: center;">Resistive Switching Test Waveforms</p> 
<p style="text-align: center;">Unclamped Inductive Switching (UIS) Test Circuit</p> 	<p style="text-align: center;">Unclamped Inductive Switching (UIS) Test Waveforms</p> 
<p style="text-align: center;">Diode Recovery Test Circuit</p> 	<p style="text-align: center;">Diode Recovery Test Waveforms</p> 

Package Description

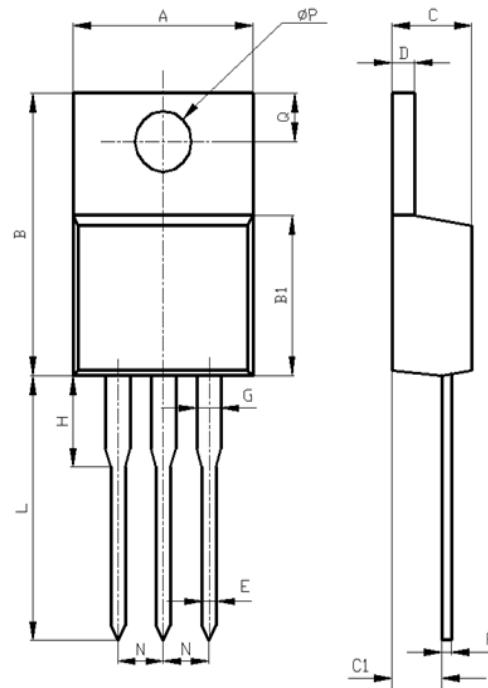

Items	Values(mm)	
	MIN	MAX
A	9.60	10.6
B	15.0	16.0
B1	8.90	9.50
C	4.30	4.80
C1	2.30	3.10
D	1.20	1.40
E	0.70	0.90
F	0.30	0.60
G	1.17	1.37
H	2.70	3.80
L	12.6	14.8
N	2.34	2.74
Q	2.40	3.00

TO-220 Package

X-ON Electronics

Largest Supplier of Electrical and Electronic Components

Click to view similar products for [MOSFET](#) category:

Click to view products by [Minos](#) manufacturer:

Other Similar products are found below :

[IRFD120](#) [IRFY240C](#) [JANTX2N5237](#) [2SK2267\(Q\)](#) [BUK455-60A/B](#) [MIC4420CM-TR](#) [VN1206L](#) [NDP4060](#) [SI4482DY](#)
[IPS70R2K0CEAKMA1](#) [SQD23N06-31L-GE3](#) [TK16J60W,S1VQ\(O](#) [2SK2614\(TE16L1,Q\)](#) [DMN1017UCP3-7](#) [EFC2J004NUZTDG](#)
[DMN1053UCP4-7](#) [SQJ469EP-T1-GE3](#) [NTE2384](#) [DMC2700UDMQ-7](#) [DMN2080UCB4-7](#) [DMN61D9UWQ-13](#) [US6M2GTR](#)
[DMN31D5UDJ-7](#) [DMP22D4UFO-7B](#) [DMN1006UCA6-7](#) [DMN16M9UCA6-7](#) [STF5N65M6](#) [IRF40H233XTMA1](#) [STU5N65M6](#)
[DMN6022SSD-13](#) [DMN13M9UCA6-7](#) [DMTH10H4M6SPS-13](#) [DMN2990UFB-7B](#) [IPB80P04P405ATMA2](#) [2N7002W-G](#) [MCAC30N06Y-](#)
[TP](#) [MCQ7328-TP](#) [NTMC083NP10M5L](#) [NVMFS2D3P04M8LT1G](#) [BXP7N65D](#) [BXP4N65F](#) [AOL1454G](#) [WMJ80N60C4](#) [BXP2N20L](#)
[BXP2N65D](#) [BXT1150N10J](#) [BXT1700P06M](#) [TSM60NB380CP](#) [ROG](#) [RQ7L055BGTCR](#) [DMNH15H110SK3-13](#)